

TM 9-801

T. O. 19-75AAA-4

WAR DEPARTMENT TECHNICAL MANUAL

TRUCK 2½-TON, 6x6 GMC CCKW-352 & 353

TECHNICAL MANUAL

**TRUCK, 2½-TON, 6 x 6 (GMC CCKW-352 AND 353) AND
TRUCK, 2½-TON, 6 x 4 (GMC CCW-353)**

CHANGES }
No. 1 }

DEPARTMENT OF THE ARMY
WASHINGTON 25, D. C., 12 September 1950

TM 9-801, 24 April 1944, is changed as follows:

The title is changed to read as follows: **TRUCK, 2½-TON, 6 x 6 (GMC CCKW-352 AND 353) AND TRUCK, 2½-TON, 6 x 4 (GMC CCW-353).**

1. Scope

a. These instructions are * * * equipment is assigned. They contain information on the operation and maintenance of the Truck, 2½-Ton, 6 x 6, GMC CCKW-352 and 353, and Truck, 2½-Ton, 6 x 4, GMC CCW-353, as well as descriptions of the major units and their functions in relation to the other components of this vehicle.

b. This manual has the following arrangement:

* * * * *

- (3) Part Three, Maintenance * * * and second echelons).
- (4) (Superseded.) Part Four, Shipment and Limited Storage and Destruction To Prevent Enemy Use, contains instructions for shipment and limited storage and for destruction of matériel to prevent enemy use.
- (5) (Added.) The appendix contains a list of current references, including supply catalogs, technical manuals, and other available publications applicable to this matériel.

2. Forms, Records, and Reports

(Superseded.)

a. GENERAL. Forms, records, and reports are designed to serve necessary and useful purposes. Responsibility for the proper execution of these forms rests upon commanding officers of all units operating and maintaining vehicles. It is emphasized, however, that forms, records, and reports are merely aids. They are not a substitute

*These changes supersede TB 9-766-2, 4 June 1945; TB ORD 85, 5 May 1943; TB ORD 281, 5 April 1945; and those portions of the following technical bulletins and technical manuals pertaining to the equipment herein: TB ORD 54, 3 March 1944; TB ORD 59, 14 July 1943; TB ORD 127, 21 July 1944; TB ORD 185, 12 September 1944; TB ORD 205, 29 September 1944; TB ORD 262, 12 March 1945; TB ORD 376, 27 February 1950; TM 10-1423, 20 July 1942; TM 10-1449, 23 March 1942.

for thorough practical work, physical inspection, and active supervision.

b. AUTHORIZED FORMS. The forms, records, and reports generally applicable to units operating and maintaining these vehicles are listed below. No forms other than approved Department of the Army forms will be used. For a current and complete listing of all forms, see current SR 310-20-6.

Department of the Army Lubrication Orders, LO 9-801 and LO 9-U315.

Standard Form 91, Operator's Report of Motor Vehicle Accident.
Standard Form 91A, Transcript of Operator's Report of Vehicle Accident.

Standard Form 93, Report of Investigating Officer.

Standard Form 94, Statement of Witness.

DA Form 30b, Report of Claims Officer.

DD Form 6, Report of Damaged or Improper Shipment.

DD Form 110, Vehicle and Equipment Operational Record.

DA AGO Form 9-68, Spot Check Inspection Report for Wheeled and Half-Track Vehicles.

WD AGO Form 9-73, Data for Registration—Motor Vehicle.

DA AGO Form 9-74, Motor Vehicle Operator's Permit.

DA AGO Form 9-75, Daily Dispatching Record of Motor Vehicle.

DA AGO Form 348, Driver's Qualification Record.

WD AGO Form 460, Preventive Maintenance Roster.

WD AGO Form 461, Work Sheet for Wheeled and Half-Track Vehicles.

DA AGO Form 461-5, Limited Technical Inspection.

DA AGO Form 468, Unsatisfactory Equipment Report.

WD AGO Form 478, Modification Work Order and Major Unit Assembly Replacement Record and Organization Equipment File.

WD AGO Form 614, Accident-Identification Card.

WD AGO Form 811, Work Request and Job Order.

WD AGO Form 811-1, Work Request and Hand Receipt.

c. FIELD REPORT OF ACCIDENTS. The reports necessary to comply with the requirements of the Army safety program are prescribed in detail in the 385-10-40 series of Special Regulations. These reports are required whenever accidents involving injury to personnel or damage to matériel occur.

d. REPORT OF UNSATISFACTORY EQUIPMENT OR MATERIALS. Any suggestions for improvement in design, maintenance, safety, and efficiency of operation prompted by chronic failure or malfunction of the matériel, spare parts, or equipment or as to defects in the application or effect of prescribed petroleum fuels, lubricants, and/or preserving materials will be reported through technical channels as

prescribed in SR 700-45-5, to the Chief of Ordnance, Washington 25, D. C., ATTN: ORDFM, using DA AGO Form 468. Such suggestions are encouraged in order that other organizations may benefit.

3. Description

a. GENERAL. Vehicles described in this manual are designated as TRUCK, 2½-ton, 6 x 6, GMC CCKW-352 and 353, and TRUCK, 2½-ton, 6 x 4, GMC CCW-353. In addition to * * * other wheeled equipment.

b. GENERAL CHARACTERISTICS.

* * * * *
(2) *Axles, suspension, and steering.* Driving axles are full floating and may be either split or banjo type. Suspension of axles * * * of rear axles.

(a) (Added) *GMC CCKW-352 and 353.* The GMC CCKW-352 and 353 have three driving axles. The front axle incorporates special universal joints at the steering knuckles which permit steering of vehicle in conventional automotive manner.

(b) (Added) *GMC CCW-353.* The GMC CCW-353 has an "I beam" type of front axle without any provision for receiving or transmitting power (dead axle).

* * * * *
(4) *Power drive units.* Axles are driven * * * type drive shafts.

(a) (Added) On the GMC CCKW-352 and 353, a two speed transfer case permits drive by rear axles, or front and rear axles, depending upon position of the manual shift levers.

(b) (Added) On the GMC CCW-353, the low speed range is blocked out; hence, there are no manual shift levers.

* * * * *

Section III. PARTS, SPECIAL TOOLS, AND EQUIPMENT FOR ORGANIZATIONAL MAINTENANCE

6. General

(Superseded.)

Tools and equipment are issued to the using organization for maintaining the matériel. Tools and equipment should not be used for purposes other than prescribed and, when not in use, should be properly stored in the chest and/or roll provided for them. Spare parts are supplied to the using organization for replacement of those parts likely to become worn, broken, or otherwise unserviceable when

such operations are within the scope of organizational maintenance functions. Spare parts, tools, and equipment supplied for the 2½-ton 6 x 6 truck (GMC CCKW-352 and 353) and 2½-ton 6 x 4 truck (GMC CCW-353) are listed in Department of the Army Supply Catalog ORD 7 SNL G-508, which is the authority for requisitioning replacements.

7. Common Tools and Equipment

(Superseded.)

Standard and commonly used tools and equipment having general application to this matériel are listed in the ORD 7 catalog but are not specifically identified in this manual.

8. Special Tools and Equipment

(Superseded.)

Certain tools and equipment specially designed for organizational maintenance, repair, and general use with the matériel are listed in table I for information only. This list is not to be used for requisitioning replacements.

Table I. Special Tools and Equipment for Organizational Maintenance

| Item | Identifying No. | References | | Use |
|--|-----------------|------------|------|---|
| | | Fig. | Par. | |
| ADAPTER, puller, steering wheel. | 41-A-18-251 | 211 | 206 | Remove steering wheel. |
| REMOVER, bearing cone (front), main shaft. | 41-R-2368-200 | --- | --- | |
| WRENCH, wheel bearing nut, dble-end tubular, pronged, OD 3 and 3¾ in, No of prongs 6 each end, length 3½ in* | 41-W-3748-100 | --- | 199c | Used on vehicles with banjo type GMC axle. |
| WRENCH, wheel bearing nut, sgle-end tubular, hex, size of opng 3¼ in* | 41-W-3825-100 | --- | 199c | Used on vehicles with split type Timken axle. |

*On vehicle tools.

Figure 11—Pioneer tools, spare parts kit, and oil can spout—is rescinded.

Figure 12—Tools and spare parts—is rescinded.

Figure 13—Tank body compartments—is rescinded.

9. On Vehicle Spare Parts

Rescinded. See paragraph 6.

10. Special Tools

Rescinded. See paragraph 8 and table I.

13. Lever Controls

a. Hand-operated lever * * * located in cab (fig. 14).

* * * * *

(2) *Transfer case* (superseded).

(a) *GMC CCKW-352 and 353*. The transfer case shift lever is used to shift transfer case into high or low range to engage driving axles, and into neutral to disengage axles. Arrangement of this lever is such that low range cannot be used until front axle lever is placed into IN position. Shifting instructions are outlined in paragraph 16.

(b) *GMC CCW-353*. The transfer case has the low speed range blocked out, hence, there are no manual shift levers.

(3) *Front axle* (superseded).

(a) *GMC CCKW-352 and 353*. The front axle declutching lever is used to engage and disengage the front driving axle. The lever has only two shifting positions IN and OUT. The lever must be placed into IN position (axle engaged) before transfer case shift lever can be placed into low range position. Shifting instructions are outlined in paragraph 16.

(b) *GMC CCW-353*. The front axle is of the "I-beam" type and is not capable of transmitting power (dead axle). It does not have a declutching lever.

* * * * *

15. Miscellaneous Controls

* * * * *

g. (Added) **LOAD CONTROL DIAL (SOME VEHICLES)** (fig. 17.1). The load control dial of the trailer brake controller (par. 178.1) is numbered from one to four and is used to vary the severity of brake application on a trailer in accordance with the load carried on the trailer. Number one position on the dial is for a very light load and number four is for a maximum load.

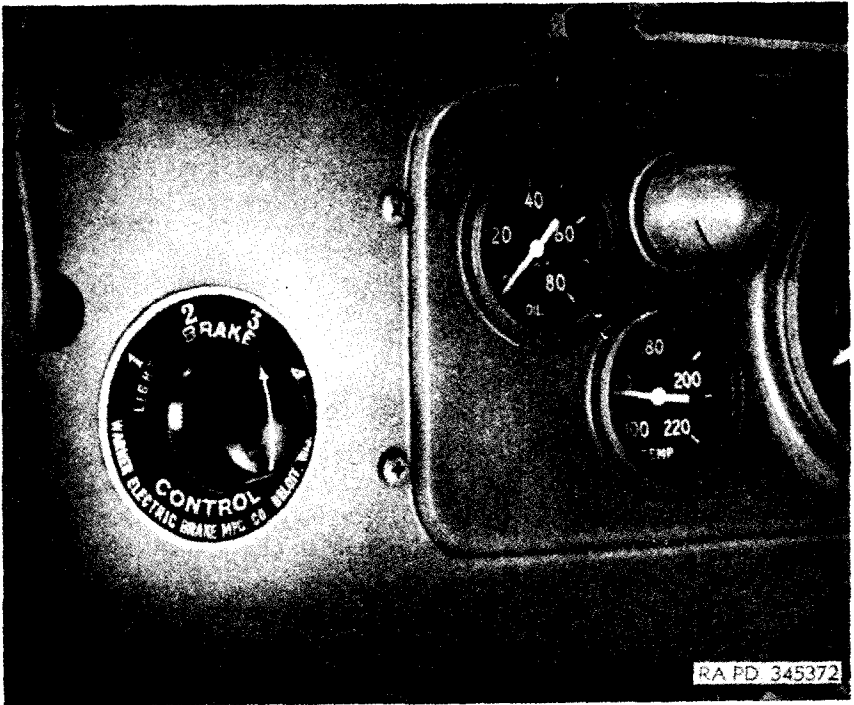

Figure 17.1 (added). Load control dial.

16. Transmission, Transfer Case, and Front Axle Shifting

a. GENERAL. The CCW-353 model does not have a transfer shift lever and has a dead front axle. In all other respects it is similar to the CCKW-352 and 353 models. The purpose and * * * the transfer case.

* * * * *

17. Engine Fuel, Oil, and Water

* * * * *

b. CRANKCASE OIL (fig. 21). Crankcase oil filler * * * for lubrication instructions. If vehicle is to be left standing with oil or coolant drained, attach suitable tag in conspicuous place at driver's position to insure that engine will not be started.

* * * * *

18. Operating the Engine

a. STARTING ENGINE. If vehicle has * * * outlined in paragraph 29. Inspect vehicle to be sure no warning tags are present to indicate that water or oil has been drained or to warn against opera-

tion of the vehicle. Perform before-operation services outlined in table II.

* * * * *

19. Driving the Vehicle

* * * * *

b. UNUSUAL CONDITIONS AND AUXILIARY EQUIPMENT. A thorough study * * * auxiliary equipment (pars. 24 through 28).

* * * * *

25. Cargo Dump Body Operation

* * * * *

b. HOIST OPERATION.

(1) *General.* Hoist should only * * * for dumping purposes.

Caution: Do not operate hoist pump when vehicle is in motion. The pump may overheat and the components expand and seize, causing damage to the pump shaft, gears, or case. Controls for the * * * lower the body.

* * * * *

29. Cold Weather Operation

a. GENERAL. The operation and * * * demand special precautions. In all cases where the normal lubricants cannot be effectively removed while warm nor forced out with the lighter grades required for subzero operation, it is absolutely essential that the affected parts be disassembled, washed in volatile mineral spirits paint thinner or dry-cleaning solvent, and dried before lubricating with the prescribed Arctic grade lubricants.

b. GASOLINE. For tactical operations in temperatures consistently below 0° F., Arctic grade motor fuel, designed for tactical operations will be used. When these vehicles are to be used for administrative purposes only Arctic grade motor fuel designed for administrative use may be used.

(1) *Storage.* Due to condensation * * * precautions are taken.

* * * * *

(c) Add 1 quart of denatured alcohol, grade III, to the fuel tank at start of subzero weather, and one-half pint at each refilling thereafter. This will reduce * * * in the fuel.

* * * * *

e. (Added) OVERNIGHT OR LONG STANDING. At temperatures below 0° F., batteries should be removed from vehicles which are in

the open and inactive for more than 1 or 2 hours, depending upon the temperature. These batteries should be kept in any available shelter in which the temperature is maintained above freezing. When a vehicle is to be used after standing in the open at temperatures below -20° F. for over 1 or 2 hours, its engine should be heated externally before operation. This may be performed with an auxiliary cold starting aid kit (slave kit) when available. Otherwise, cover the engine with a tarpaulin and place any available stoves or heaters under the tarpaulin until the engine has heated sufficiently for operation.

Caution: Extreme care should be exercised to avoid applying a direct flame to the oil pan due to fire hazard.

30. Cold Weather Lubrication

(Superseded.)

a. GENERAL. Lubricants will be as specified in lubrication order (figs. 46, 47, 47.1, and 47.2) as modified below.

b. ENGINE. Sub-zero engine oil (OES) will be used in place of the regularly prescribed lubricant when subzero operation is required. This oil is suitable for use at temperatures as low as -65° F. and therefore no dilution is required.

c. TRANSMISSION, TRANSFER CASE, AND DIFFERENTIALS. For operation at temperatures consistently below 0° F., drain gear cases while warm and refill with subzero universal gear lubricant (GOS).

d. STEERING GEAR. Drain, flush, and refill with subzero universal gear lubricant (GOS). Disassemble steering gear joints and, after cleaning thoroughly, lubricate with Ordnance Department lubricating grease No. 00 (OGOO).

e. HYDROVAC CYLINDERS. Lubricate with petroleum base hydraulic oil (OHA) (AN-O-366).

f. GREASE POINTS. All points for which any type of grease is normally prescribed will be lubricated with Ordnance Department lubricating grease No. 00 (OGOO).

g. OIL CAN POINTS. Where engine oil normally is prescribed, use preservative lubricating oil (special) (PS) when subzero temperatures are encountered.

31. Protection of Cooling System and Preparation of Vehicle for Cold Weather Operation

a. PROTECTION OF COOLING SYSTEM (superseded).

(1) General.

(a) Before adding antifreeze compound, it is necessary that the cooling system be clean and completely free from rust. If the cooling system has been cleaned recently, it may be necessary only to drain, refill with clean water, and again

drain. Otherwise, the system will be cleaned with cleaning compound. For use of reclaimed antifreeze solutions, refer to TM 9-850.

- (b) Heaters, water-cooled compressors, and other units in the cooling system must be cleaned in addition to the radiator and engine water jacket.
 - (c) All hoses must be inspected and replaced if deteriorated. Hose clamps, plugs, and petcocks must be inspected and tightened if necessary. Radiator leaks must be repaired before adding antifreeze compound. Exhaust gas or air leakage into the cooling system must be corrected.
- (2) *Extreme cold weather operation.* Where temperatures consistently below -20° F. are encountered, arctic winter antifreeze compound will be used. This compound is premixed and no water nor any other substance will be added to it at any time. Since this compound is inflammable, it must be kept away from open flames.
- (3) *Moderate cold weather operation.*
- (a) At temperatures between $+32^{\circ}$ and -20° F., the cooling system will be protected by ethylene glycol antifreeze compound, mixed with water in the following proportions for the temperature 10° F. below the lowest experienced during the winter season:

| <i>Atmospheric temperature °F.</i> | <i>Quantity of ethylene glycol (qt)</i> | <i>Quantity of water (qt)</i> |
|------------------------------------|---|-------------------------------|
| +20 ----- | 3¼ | 15¼ |
| +10 ----- | 4¼ | 14¼ |
| 0 ----- | 6½ | 12½ |
| -5 ----- | 7 | 12 |
| -10 ----- | 7½ | 11½ |
| -15 ----- | 8 | 11 |
| -20 ----- | 8½ | 10½ |
| -30 ----- | 9¼ | 9¾ |
| -40 ----- | 10 | 9 |

- (b) After adding this antifreeze compound, fill with water to slightly below the filler neck. Then start and warm the engine to normal operating temperature. Stop the engine and check the solution with a hydrometer, adding antifreeze compound if required. Thereafter, the coolant will be inspected weekly while in service for strength and color. A rusty solution should be drained and the cooling system thoroughly cleaned before the addition of new solution of required strength. Keep antifreeze solutions clean and avoid spilling on painted surfaces. The accuracy of the hydrometer is important and may be checked by mixing one part antifreeze compound to two

parts of water which should produce a reading indicating protection to 0° F.

* * * * *

c. ENGINES.

* * * * *

(4) *Air cleaners* (superseded). At subzero temperatures, remove air cleaner, disassemble, wash all parts in volatile mineral spirits paint thinner or dry-cleaning solvent, dry thoroughly, and reassemble. Refill to correct level with subzero engine oil (OES). Check reservoir daily and fill to correct level if necessary. Every 1,000 miles, disassemble, wash, dry, reassemble, and refill

* * * * *

e. CHASSIS.

* * * * *

(2) Inspect the vehicle * * * nuts jarring loose. Cables should operate satisfactorily at all temperatures providing they are coated with **Ordnance Department lubricating grease No. 00 (OGOO)** and there is no excess grease in the housing.

Section VIII. LUBRICATION AND PAINTING (Superseded.)

36. Lubrication Order

Lubrication Orders LO 9-801 and LO 9-U315 (figs. 46, 47, 47.1, and 47.2) prescribe cleaning and lubricating procedures as to locations, intervals, and proper materials for the vehicles. An order is issued with the vehicle and is to be carried with it at all times. In the event the vehicle is received without a copy, the using organization will immediately requisition one. (See SR 310-20-4 for LO of current date.) Lubrication which is to be performed by ordnance maintenance personnel is listed on the lubrication order in the NOTES.

37. General Lubrication Instructions

a. USUAL CONDITIONS. Service intervals specified on the lubrication order are for normal operation where moderate temperature, humidity, and atmospheric conditions prevail.

b. LUBRICATION EQUIPMENT. Each vehicle is supplied with lubrication equipment adequate for its maintenance. This equipment will be cleaned both before and after use. Lubricating guns will be operated carefully, and in such a manner as to insure a proper distribution of the lubricant.

c. POINTS OF APPLICATION.

- (1) Lubricating fittings, grease cups, oilers, and oil holes are shown in figures 48 through 56 and are referenced to the lubrication order. Wipe these devices and the surrounding surfaces clean, before lubricant is applied.
- (2) A $\frac{3}{4}$ -inch red circle should be painted around all lubricating fittings and oil holes.

d. REPORTS AND RECORDS.

- (1) Report unsatisfactory performance or defects in the application or effect of prescribed petroleum fuels, lubricants, and preserving materials in accordance with paragraph 2.
- (2) Maintain a record of lubrication of the vehicle on WD AGO Form 460.

37.1 Lubrication Under Unusual Conditions

a. UNUSUAL CONDITIONS. Reduce service intervals specified on the lubrication order to compensate for abnormal operation and extreme conditions, such as high or low temperatures, prolonged periods of high speed operation, continued operation in sand or dust, immersion in water, or exposure to moisture, any one of which may quickly destroy the protective qualities of the lubricant. Intervals may be extended during inactive periods.

b. CHANGING GRADE OF LUBRICANTS. Lubricants are prescribed in the "Key" in accordance with four temperature ranges—above 32° F., from 32° to 0° F., from 0° down to -40° F., and below -40° F. When to change grade of lubricants is determined by maintaining a close check on operation of the vehicle during the approach to change-over periods in accordance with weather forecast data. Sluggish starting is an indication of lubricants thickening, and is the signal to change to grade prescribed for the next lower temperature range. Ordinarily, it will be necessary to change grade of lubricants only when air temperatures are consistently in the next higher or lower range.

37.2 Painting

Instructions for the preparation of the matériel for painting, methods of painting, and materials to be used are contained in TM 9-2851.

LUBRICATION ORDER LO 9-801

4 October 1948 (Supersedes WDLO 9-801, 5 FEBRUARY 1945)

TRUCK, 2 1/2-TON, 6x6 (GMC MODELS CCKW-352 AND CCKW-353)

Reference: ORD 7 SNL G-508; TM 9-801

Intervals are stated on normal application. Reference to components for abnormal operation with adequate preservation. Lubricate after washing and loading.

Clean fittings before lubricating.

Clean parts with SOLVENT, dry, cleaning. Dry before lubricating.

Lubricate correct draw points on both sides.

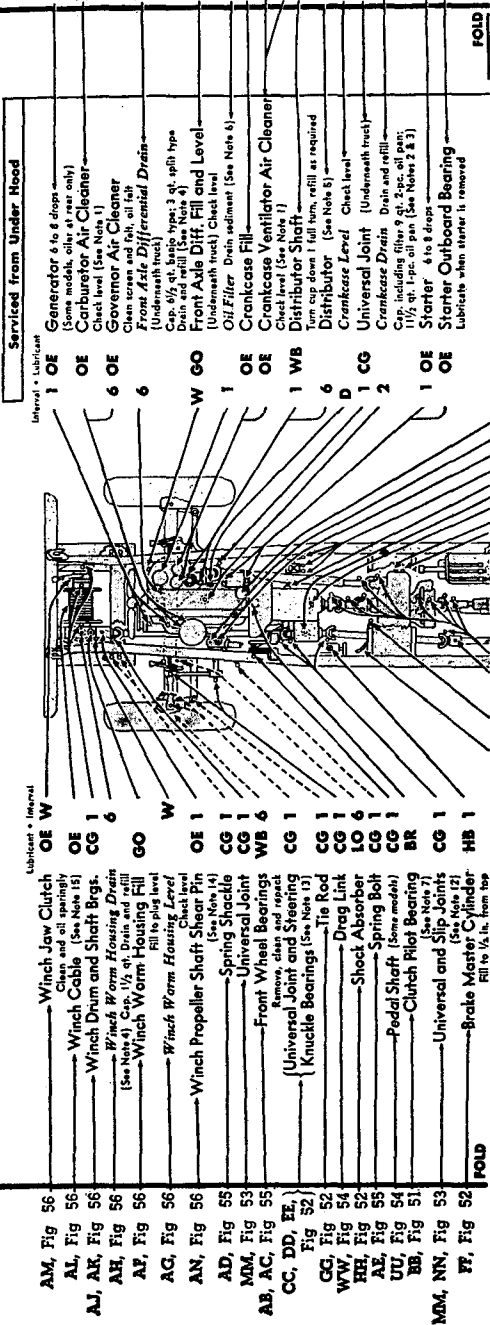

- J, Fig 48
- K, L, Fig 49
- V, X, Fig 50
- U, W, Fig 50
- D, Fig 48
- A, Fig 48
- M, Fig 48
- M, Fig 49
- E, Fig 48
- F, Fig 48
- B, Fig 48
- LL, Fig 53
- C, Fig 48
- G, Fig 48
- H, Fig 48

- Serviced from Under Hood**
- 1 OE Generator 6 to 8 drops (Some models, oil, 2 per oz.)
 - OE Carburetor Air Cleaner
 - 6 OE Check level (See Note 1)
 - 6 OE Governor Air Cleaner
 - 6 OE Clean screens and oil, oil fat
 - W GO Front Axle Differential Drains (Underneath truck)
 - 1 OE Cap. 1/2 qt. base type; 3 qt. split type
 - 1 OE Front Axle Diff. Fill and Level (Underneath truck) Check level
 - 1 OE Oil Filter Drain sediment (See Note 6)
 - 1 OE Crankcase Fill
 - 1 OE Crankcase Ventilator Air Cleaner
 - 1 OE Check level (See Note 1)
 - 1 WB Distributor Shaft
 - 6 Distributor (See Note 5)
 - D Crankcase Level Check level
 - 1 CG Universal Joint (Underneath truck)
 - 2 Drain and refill
 - 1 OE Cap. including filter 9 qt. 2-sec. oil pan; 1 1/2 qt. 1-sec. oil pan (See Notes 2 & 3)
 - 1 OE Starter 6 to 8 drops
 - OE Starter Outboard Bearing Lubricate when starter is removed

- AM, Fig 56
- AL, Fig 56
- AJ, AK, Fig 56
- AH, Fig 56
- AF, Fig 56
- AC, Fig 56
- AN, Fig 56
- AD, Fig 56
- MM, Fig 53
- AB, AC, Fig 55
- CC, DD, EE, Fig 52
- GC, Fig 52
- WW, Fig 54
- HH, Fig 52
- AE, Fig 55
- UU, Fig 54
- BB, Fig 51
- MM, NN, Fig 53
- FF, Fig 52

- Interval - Lubricate
- 1 OE Winch Jaw Clutch Clean and oil sparingly
- OE Winch Cable (See Note 15)
- CG 1 Winch Drum and Shaft Brgs. (See Note 4)
- GO Winch Worm Housing Drains Cap. 1/2 qt. Drain and refill
- W Winch Worm Housing Fill Fill to plug level
- OE 1 Winch Worm Housing Level
- CG 1 Winch Propeller Shaft Shaft Pin (See Note 14)
- CG 1 Spring Shackles
- CG 1 Universal Joint
- WB 6 Front Wheel Bearings (See Note 7)
- CG 1 (Universal Joint and Steering Knuckle Bearings (See Note 13))
- CG 1 Tie Rod
- CG 1 Drag Link
- LO 6 Shock Absorber
- CG 1 Spring Bolt (Some models)
- BR Clutch Pilot Bearing (See Note 7)
- CG 1 Universal and Slip Joints (See Note 12)
- HB 1 Brake Master Cylinder for Fill to 1/4 in. from top

FOLD

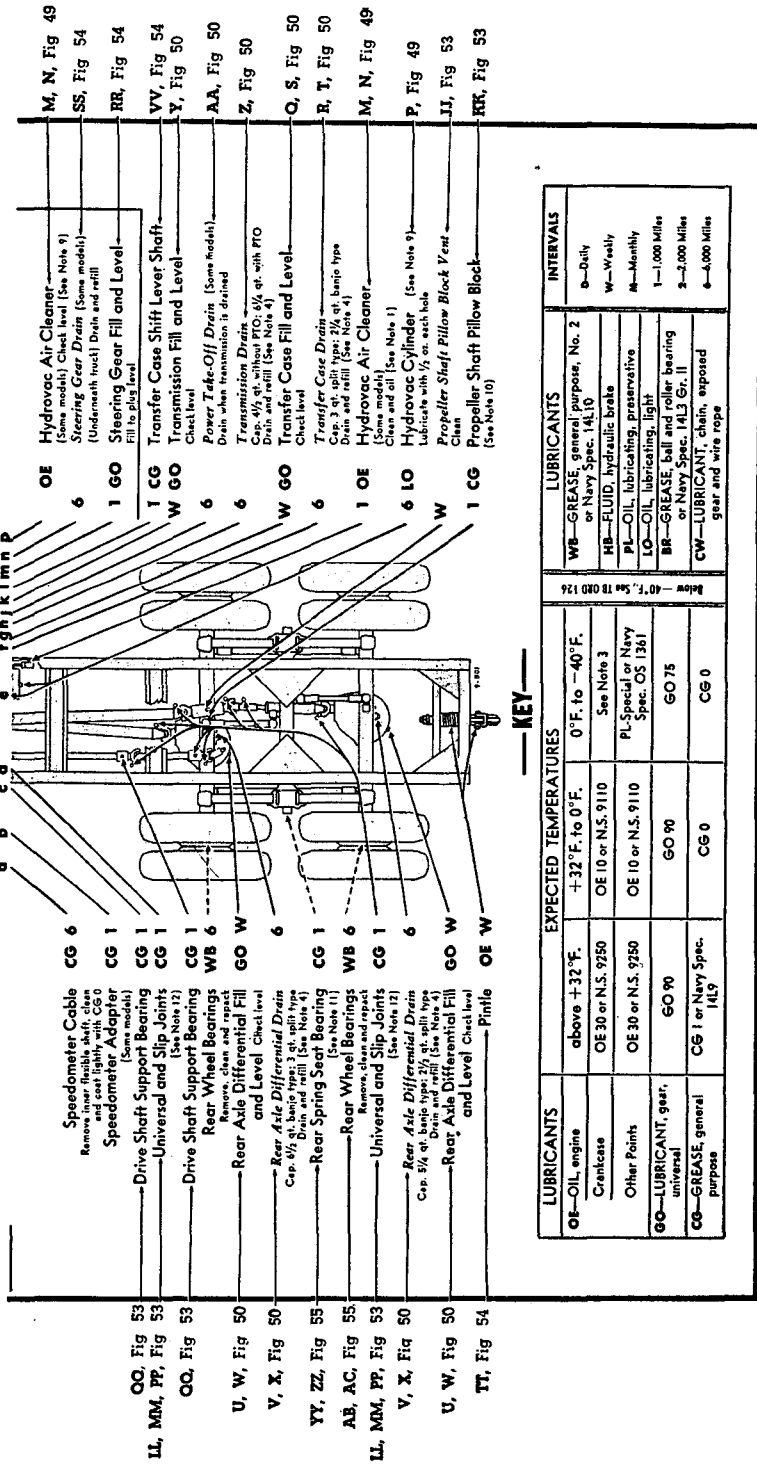

RA PD 355063B

Figure 46. Lubrication order LO 9-801 (front).

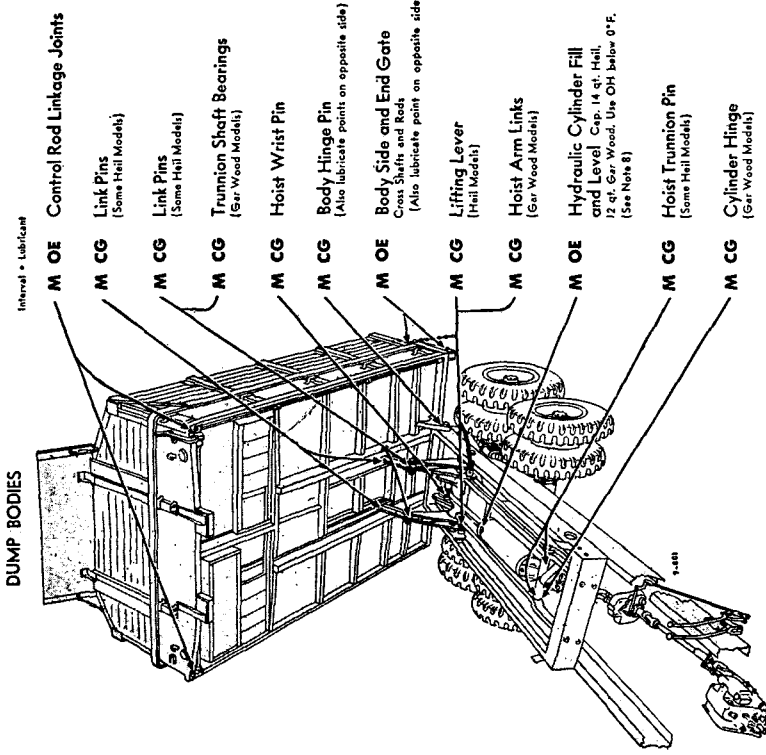

Interval • Lubricant

DUMP BODIES

CAUTION
Always place a prop or block under body before performing any service work.

NOTES

1. **AIR CLEANERS AND BREATHERS—(Oil Bath Type)**
After every 8 hours of operation replenish to head level with OE. (For temperatures above 0°F., use crankcase grade; from 0°F. to -40°F., use 4 parts of OE 10 with 1 part diluent. Diesel fuel, if available, is preferred as diluent but gasoline may be used.) Every 1,000 miles, disassemble, wash all parts and refill with OE as above. For desert or similar sandy soil operation, disassemble, wash all parts, and refill with OE above every 4 hours or more frequently if required. (Mesh Type) For normal operation, wash and recoil at indicated intervals with OE as above. For desert or similar sandy soil operation, disassemble, wash all parts, and recoil every 100 miles.

2. **CRANKCASE—**Drain only when engine is hot. To aid in complete draining, the front end of the truck should be slightly higher than the rear. Refill to FULL mark. Run engine a few minutes, recheck level.

3. **ENGINE OIL BELOW 0°F.—**If equipment such as winterization kit, slave kit or heated storage is available, use OE 10 undiluted. If dilution is required, gasoline or Diesel fuel may be used but gasoline, if available, must be used. Therefore, fill oil reservoir with OE 10 to normal FULL mark on dipstick. Add diluent to oil reservoir in ratio of 1/2 qt. to each 5 qt. of reservoir capacity—approximately 2 3/4 qt. of diluent (2-pc. pan); 3 1/2 qt. (1-pc. pan). Run engine 5 to 10 minutes to mix lubricant and diluent thoroughly. Stop engine and note level of the diluted lubricant above the normal FULL mark on the gage or dipstick for future reference. Under operation check oil level frequently. During operation add OE 10 if level drops below normal FULL mark. Upon shutdown of engine add OE 10 to normal FULL mark and diluent to diluent FULL mark if anticipated shutdown time will be sufficient to cool engine.

FOLD

FOLD

15. WINCH CABLE—After each use, clean and oil with OE. Semiannually, if cable is not generally used, unroll entire cable and soak, by means of a brush, with PL-Special. Wipe off excess and coat cable with CW. Coat winch drum also with CW before rewinding cable on drum.

16. OIL CAN POINTS—Every 1,000 miles, lubricate Hand Brake Linkage, Brake Pedal Hubs and Clevis Pins, Clutch Pedal Linkage, Rear or Case Control Lever Bushings and Clutches, Brake Pedal Shaft (if not equipped with fitting), OE (Water Tank) Every 1,000 miles, lubricate control linkage on Emergency Brake and Clevis Pins, etc., with OE (See 14). Every 1,000 miles, lubricate Selector Operating Valve Housings and Linkages, Mainlobe Cover Hinges, etc., with OE.

17. DO NOT LUBRICATE—Fan, Water Pump, Clutch Release Bearing, Generator (some models), Springs.

18. DISASSEMBLED FOR LUBRICATION BY ORDINANCE PERSONNEL—Steering Column, Upper Bearing (Annually—BR), Steering Column Horn Contacts (Annually—PL).

Copy of this Lubrication Order will remain with the equipment at all times; instructions contained herein are advisory and supersede all conflicting lubrication instructions dated prior to the date of this Lubrication Order.

BY ORDER OF THE SECRETARY OF THE ARMY:

OMAR N. BRADLEY,
Chief of Staff.

OFFICIAL:

EDWARD F. WITSELL,
Major General,
The Adjutant General.

RA PD 355064

move plug in rear of cylinder and lubricate with about 1 oz. of LO. Replace plug. Every 1,000 miles, also lubricate vacuum cylinder, lever bearing located on frame ahead of cylinder, through fitting, with CG. 10. PROPELLER SHAFT PALLOW BLOCK—Remove level plug on side of housing and install fitting. Apply CG through fitting until lubricant appears at vent on top of housing. Do not replace level plug.

11. REAR SPRING SEAT BEARINGS—Lubricate through fitting until grease shows at inner seat.

12. UNIVERSAL AND SLIP JOINTS (Winch and Hoist)—Vents are not provided. Apply lubricant until it appears at journal and splines. Lubricate hoist support bearings until lubricant appears between bearing and shaft.

13. UNIVERSAL JOINTS AND STEERING KNUCKLE BEARINGS—Lubricate with vehicle on level ground. If split type axle is equipped with plug in hub driving flange, remove and insert fitting. Remove plug at steering knuckle housing. Lubricate first through fitting in upper steering knuckle bearing, and then through fitting inserted in hub, driving flange. Until lubricant is visible at plug hole. Replace plugs. To lubricate split type axles without plug in hub driving flange, remove plug in steering knuckle housing and lubricate through fitting on upper steering knuckle until lubricant is visible at plug opening. On banjo type axles, where two plugs are provided, one on top of joint, the other at front of steering knuckle support, remove plug in steering knuckle support and lubricate through fitting underneath joint until lubricant is visible at plug opening. Every 6,000 miles, remove universal joints, wash and repack with CG.

14. WINCH PROPELLER SHAFT SHEAR PIN—Every 6,000 miles, disconnect front universal joint, remove shear pin and universal joint from shaft, clean, dry and coat end of shaft and inside of universal joint collar with CG to prevent rusting.

4. GEAR CASES—Drain only after operation. Fill to plug levels before operation and after draining. Fill front and rear banjo type axle differentials to level of lower plug hole; (Transfer Case Decalclutching Unit, Split Type Axle) If disassembled, refill on assembly through fill plug hole with GO.

5. DISTRIBUTOR—Every 6,000 miles, wipe breaker arm lightly with CG and lubricate breaker arm pivot and wick under rotor with 1 or 2 drops of OE.

6. OIL FILTER—Every 6,000 miles, while crantcase is being drained, remove element, clean inside of case and install new element.

7. CLUTCH PILOT BEARING—Whenever clutch or engine is removed, clean and repack clutch pilot bearing with BR. After cleaning parts, fill cavity in crankshaft behind clutch pilot bearing. Also fill clutch release bearing inside recess and coat fork groove; coat shaft splines, release fork socket and stud. CAUTION: Do not wash clutch release bearing.

8. HYDRAULIC CYLINDER—(Hull) To fill hydraulic cylinder, raise body to only 1/2 its maximum height. While in this position remove filler and vent plug and fill with OE to overflowing. When the cylinder is full, raise the body to maximum elevation, then add approximately 1/2 pt. of OE. Do not replace vent plug. Release lower body, insert plug. Release vent plug, excess oil through the vent plug. Release vent plug with body at maximum height. Semiannually drain through plug in pump and refill (Gar Wood) To fill hydraulic cylinder, raise body to maximum height. Remove filler plug and fill with OE to overflowing. Install plug. Slowly raise and lower body several times. Recheck oil level and fill to plug hole. Replace plug. Semiannually drain and refill to plug hole under pump and refill.

9. HYDROVAC CYLINDER—Some models are equipped with brake vacuum cylinder located on left side of frame to rear of transfer case. Every 6,000 miles, re-

LO 9-401

DISTRIBUTION: Army Tech Sr (2), Am & S; Bd (1); AFF (2); OS Maj Comd (10); Base Comd (2); MDW (5); A (21) (18); (Overseas) (3); CHO (2); D (2); B (5) (1); R 2, 5, 7, 9 (1); Bn 2, 3, 5, 6, 8-11, 17, 19, 44, 35 (1); C 3, 5-11, 44, 35 (1); FC (1); Class II (Inlt 9 (3)), USMA (2), Sd (5); Gen Dep (2); Ing Co (2); PE (10); (5); One (1) copy to each of the following T/O & E: 2-13; 2-28; 4-37; 4-153; 4-157; 7-25; 7-92; 7-93; 7-171; 17-171; 17-172; 19-7; 19-37; 19-47; 19-57; 19-87; 19-217; 19-237; SPECIAL DISTRIBUTION. Air Force USAF (5); USAF Maj Comd (3); BU (1); T/O & E 1-407 (1); 1-587 (1); 1-769 (1). For explanation of distribution formula see TM 38-403.

Figure 47. Lubrication order LO 9-801 (rear).

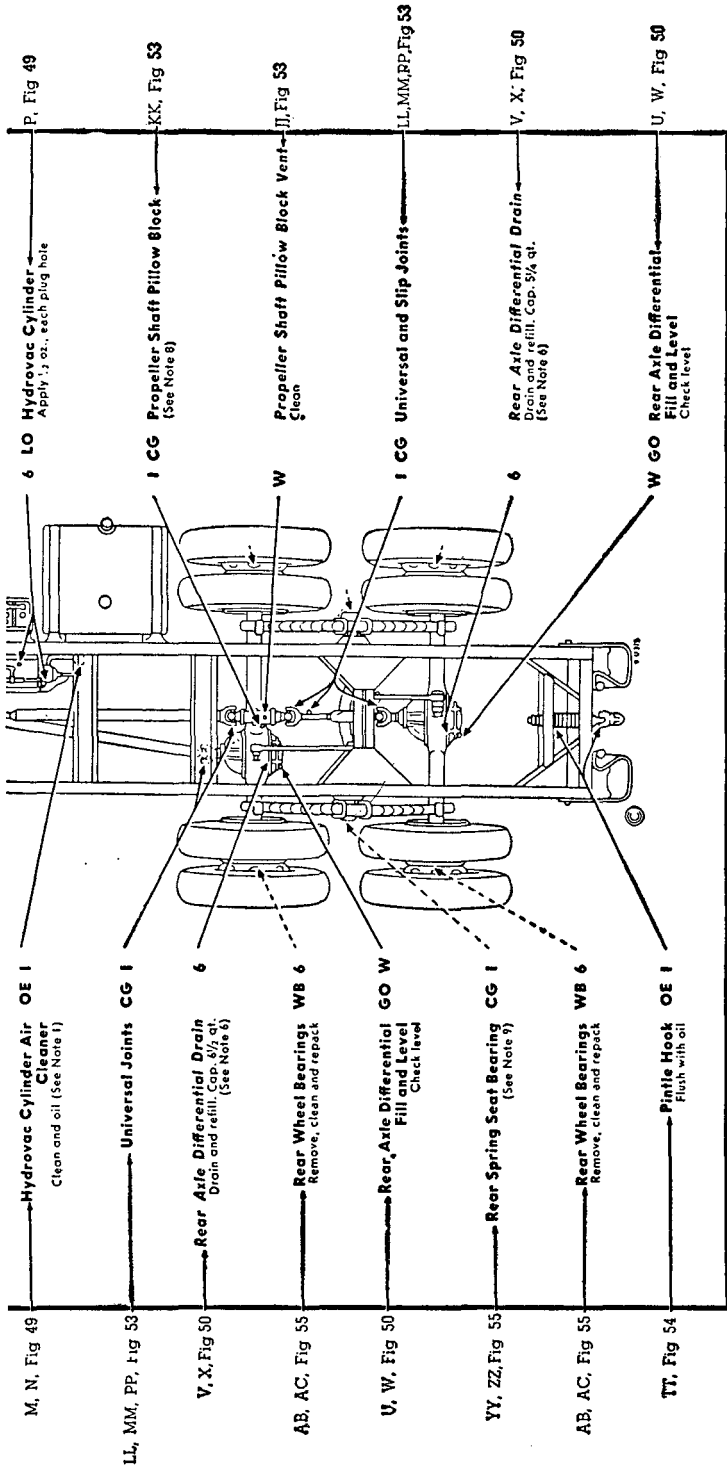

RA PD 356180A

Figure 47.1 Lubrication order LO 9-US15 (front).

———— KEY ————

| LUBRICANTS | EXPECTED TEMPERATURES | |
|--|-----------------------|-----------------------|
| OE—OIL, engine | above -32°F. | +32°F. to 0°F. |
| Crankcase. | OE 30 or N.S. 9250 | OE 10 or N.S. 9110 |
| Other Points | OE 30 or N.S. 9250 | OE 10 or N.S. 9110 |
| GO—LUBRICANT, gear, universal | Grade 90 | Grade 90 |
| CG—GREASE, general purpose | CG 1 or N.S. 1419 | CG 0 |
| WB—GREASE, general purpose, No. 2 or N.S. 14110 | | |
| HB—FLUID, hydraulic brake | | |
| LO—OIL, lubricating, light | | |
| BR—GREASE, ball & roller bearing | | |
| PL—OIL, lubricating, preservative | | |

Below -40°F., See TB ORD 126

0°F. to -40°F.
See Note 4

PL—Special
Grade 75

CG 0

INTERVALS
D—Daily
W—Weekly
1—1,000 Miles
2—2,000 Miles
6—6,000 Miles

NOTES

- AIR CLEANERS AND BREATHERS**—(Oil Bath Type) After every 8 hours of operation replenish to bead level with OE. (For temperatures above 0° F. use crankcase grade; from 0° F. to -40° F., use 4 parts OE 10 with 1 part diluent. Diesel fuel, if available, is preferred as diluent but gasoline may be used.) Every 1,000 miles, disassemble, wash all parts and refill with OE as above. For desert or similar sandy soil operation, disassemble, wash all parts, and refill with OE as above every 4 hours or more frequently if required. (Mesh Type) For normal operation, wash and refill at indicated intervals with OE as above. For desert or similar sandy soil operation disassemble, wash all parts and refill every 100 miles.
- CLUTCH PILOT BEARING**—Remove, clean and lubricate every 6,000 miles and whenever clutch or engine is removed, clean and repack pilot bearing and fill cavity in flywheel behind bearing with WB. Also pack ball seat in release fork and coat groove in release bearing for release fork and clutch splines with BR. CAUTION: Do not wash clutch release bearing.
- CRANKCASE**—Drain only after operation. Clean screen attached to drain plug on some models. After refilling, run engine a few minutes, recheck level.
- ENGINE OIL BELOW 0° F.**—If equipment such as winterization kit, slave kit or heated storage is available, use OE 10 undiluted. If dilution is required, gasoline or Diesel fuel may be used but gasoline, if available must be used. Therefore, fill oil reservoir with OE 10 to normal FULL mark on dipstick. Add diluent to oil reservoir in ratio of 1½ qt. to each 5 qt. of reservoir capacity—2¼ qt. for 9 qt. 2-piece oil pan and 3½ qt. for 11½ qt. 1-piece oil pan. Run engine 5 to 10 minutes to mix lubricant and diluent thoroughly. Stop engine and note level of the diluted lubricant above the normal FULL mark on the gage or dipstick for future reference. Under operation check oil level frequently. During operation add OE 10 if level drops below

LO 9-U315

DISTRIBUTION: ARMY—Tech Sv. (2); Arm. & Sv. Bd. (1); AFF (2); OS Maj Comd (10); Base Comd (2); MDW (3); A (ZI) (18); (Overseas) (2); CHO (2); D (2); R 9 (1); Bn 9 (1); C 9 (1); FC (1); Class if Insts 9 (3); USMA (2); Sch (5); Gen Dep 9 (2); Eng Cr (2); PE (Ord O) (5); SPECIAL DISTRIBUTION: AIR FORCE—USAF Maj Comd (2); USAF Sub Comd (3); BU (1). For explanation of distribution formula, see TM 38-405.

Requisition additional Lubrication Orders in conformance with instructions in TM 38-405.

normal FULL mark. Upon shutdown of engine add OE 10 to normal FULL mark and diluent to diluent FULL mark if anticipated shutdown time will be sufficient to cool engine.

- DISTRIBUTOR**—Every 6,000 miles, wipe breaker arm lightly with CG and lubricate breaker arm pivot and wick under rotor with 1 to 2 drops of OE.
- GEAR CASES**—Fill to plug levels before operation and after draining. Drain only after operation.
- OIL FILTER**—Every 6,000 miles, while crankcase is being drained, remove element, clean inside of case, install new element.
- PROPELLER SHAFT PILLOW BLOCK**—Remove level plug inside of housing and install fitting. Apply CG through fitting until grease appears at vent on top of housing. Do not replace plug.
- REAR SPRING SEAT BEARINGS**—Lubricate through fitting until grease shows at inner seals.
- OIL CAN POINTS**—Every 1,000 miles, lubricate Transfer Case Control Lever Bushings and Rods, Hinges, Locks, Hand Brake Linkage, Brake Pedal Pull Rod Clevis Pins, Clutch Pedal Linkage, Clutch and Brake Pedal Shaft, etc., with OE.
- DO NOT LUBRICATE**—Clutch Release Bearing, Generator Bearings (some models), Fan, Water Pump, Springs.
- DISASSEMBLED PERIODICALLY BY ORDNANCE PERSONNEL**—Steering Column Upper Bearing, Steering Column Horn Contact. Copy of this Lubrication Order will remain with the equipment at all times; instructions contained herein are mandatory and supersede all conflicting lubrication instructions dated prior to the date of this Lubrication Order.

BY ORDER OF THE SECRETARY OF THE ARMY:

OMAR N. BRADLEY

Major General, Chief of Staff, United States Army

EDWARD F. WITSELL,

Major General,

The Adjutant General.

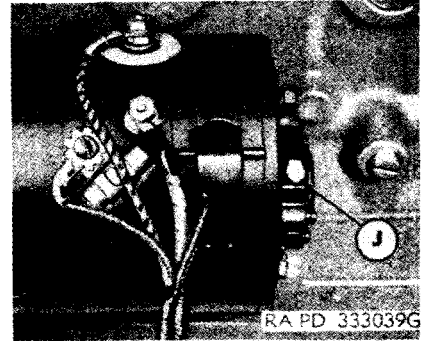
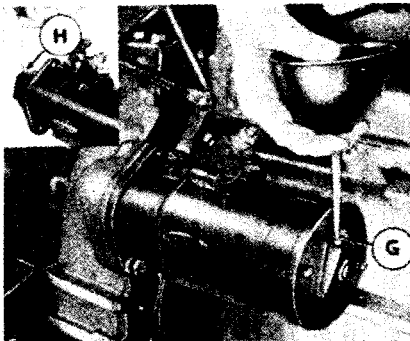
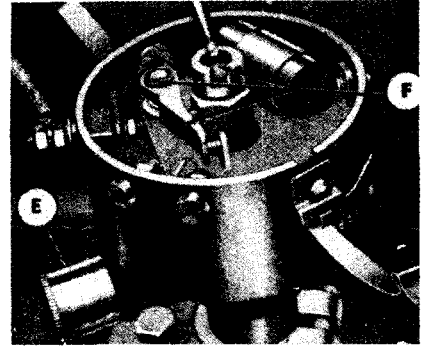
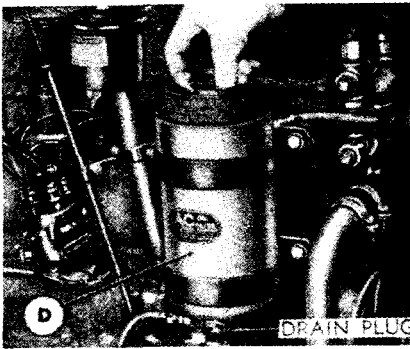
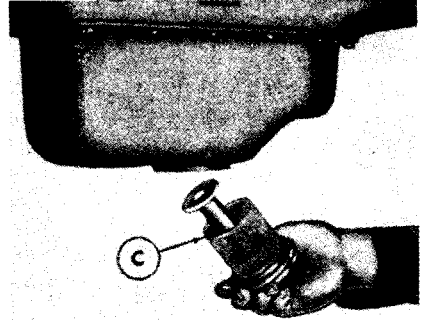
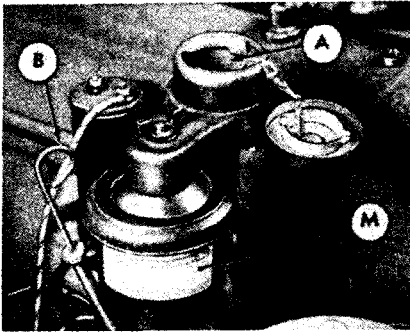

Figure 48. Lubrication localized views.

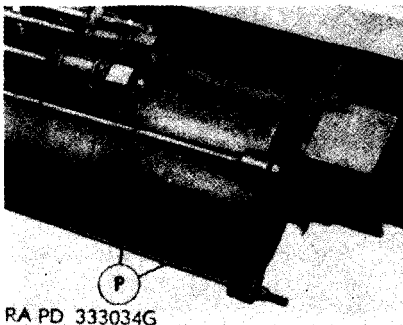
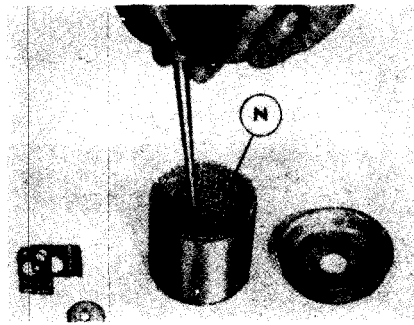
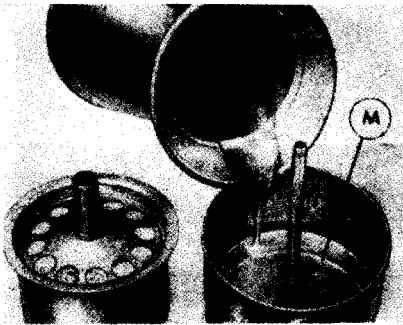
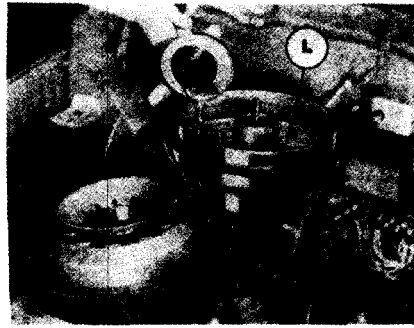
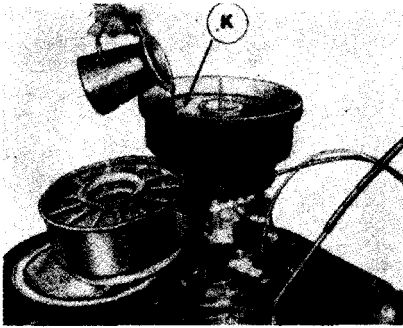

Figure 49. Lubrication localized views.

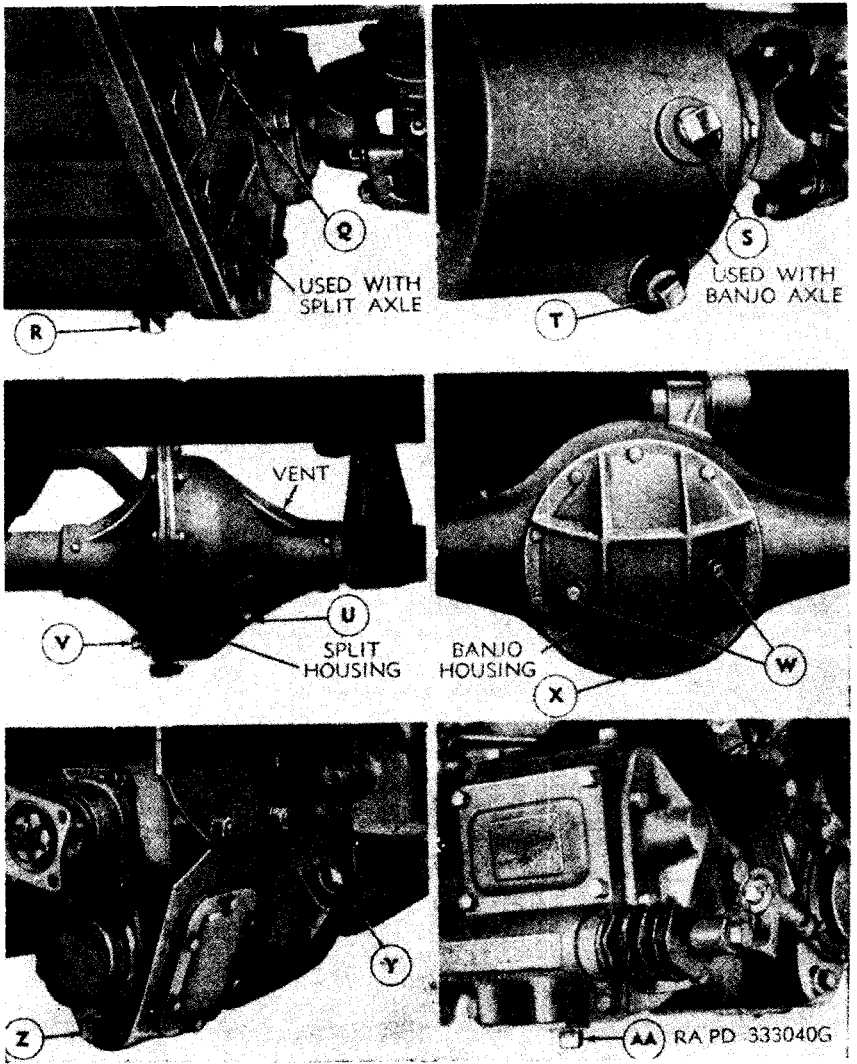
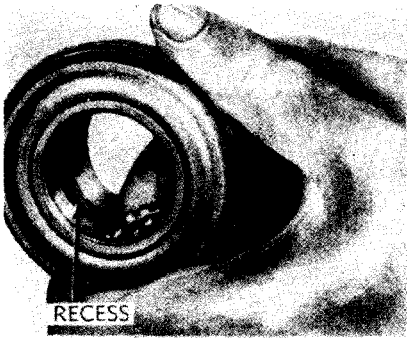

Figure 50. Lubrication localized views.



RECESS

FILL CLUTCH RELEASE BEARING SUPPORT RECESS WITH BR*



GROOVE

COAT CLUTCH RELEASE BEARING FORK GROOVE WITH BR*

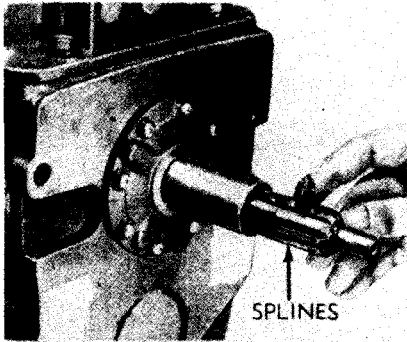

SPLINES

COAT CLUTCH SHAFT SPLINE WITH BR*

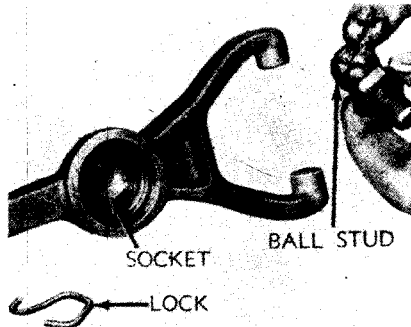

SOCKET

BALL STUD

LOCK

COAT CLUTCH RELEASE FORK SOCKET AND STUD WITH BR*

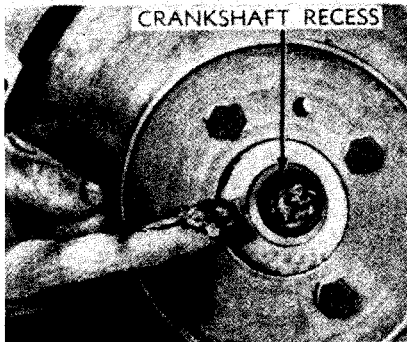

CRANKSHAFT RECESS

FILL CAVITY WITH BR*

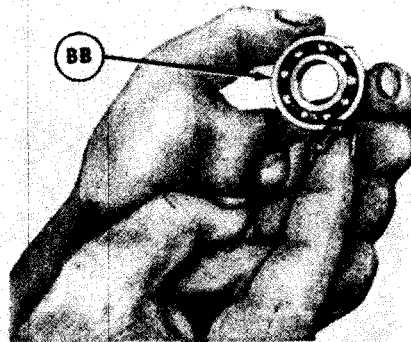

BB

RA PD 333033G

Note. See note 7, LO 9-801 (fig. 47) and note 2, LO 9-U315 (fig. 47.2).

Figure 51. Lubrication localized views.

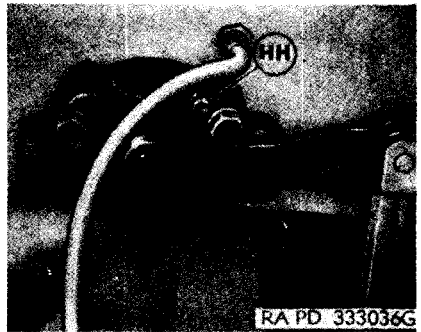
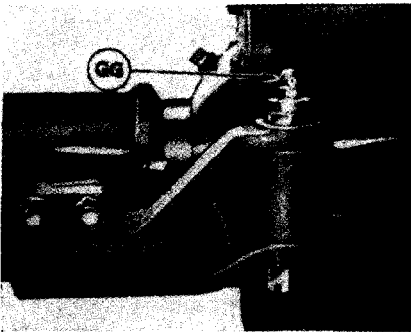
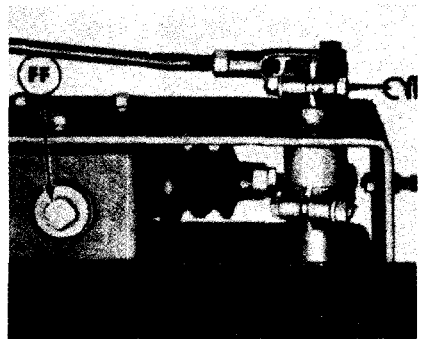
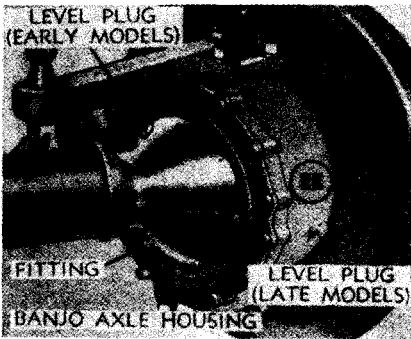
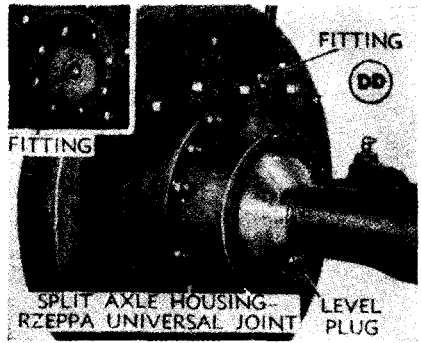
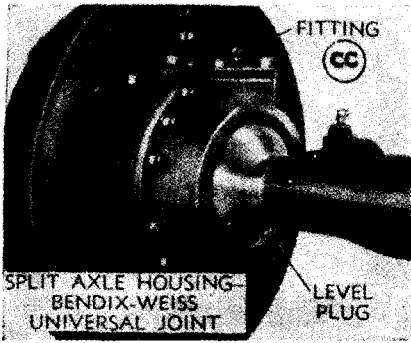

Figure 52. Lubrication localized views.

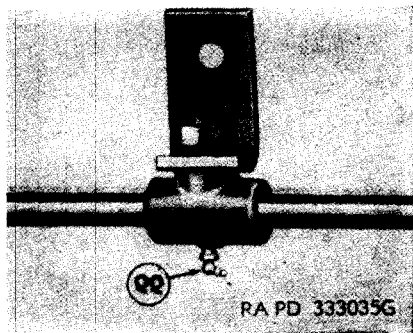
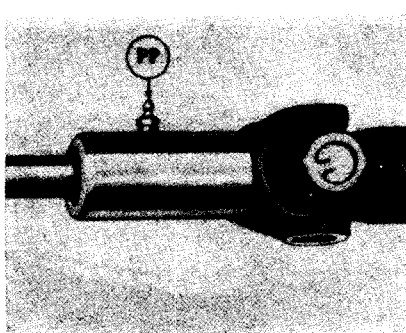
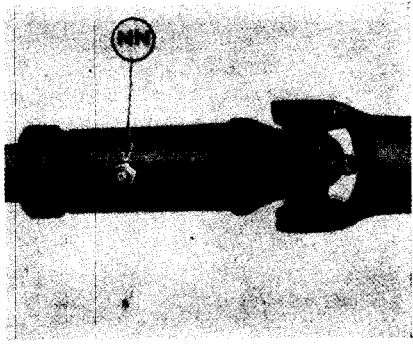
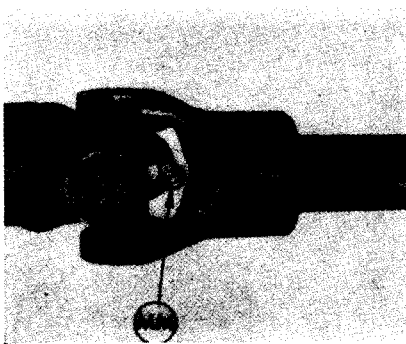
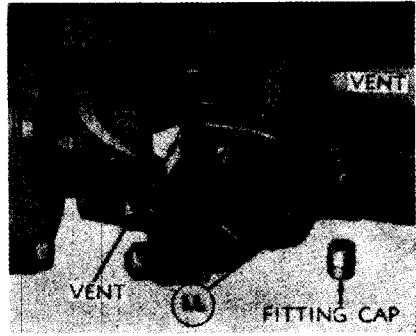
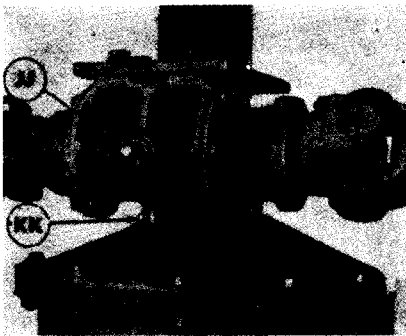
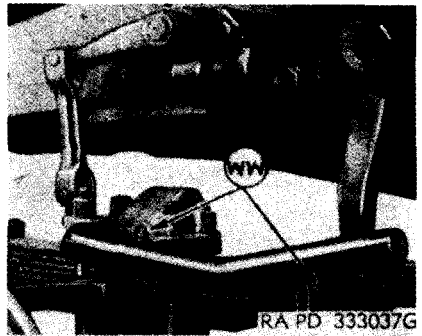
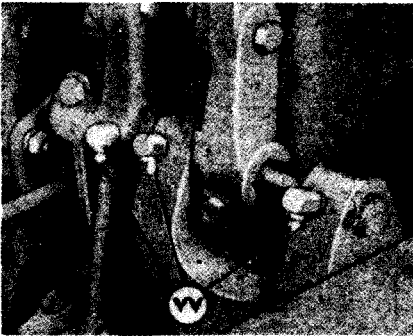
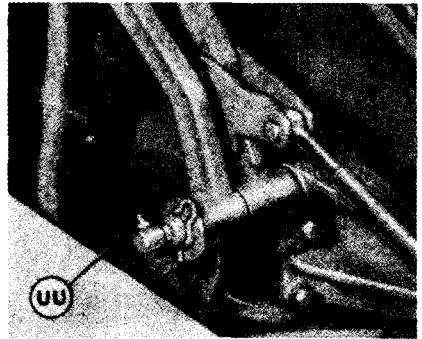
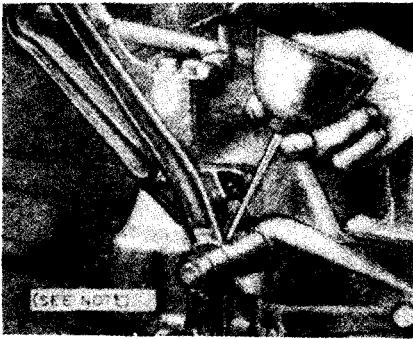
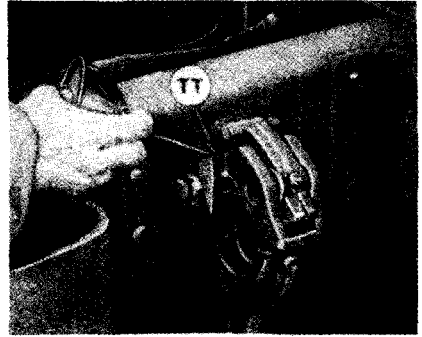
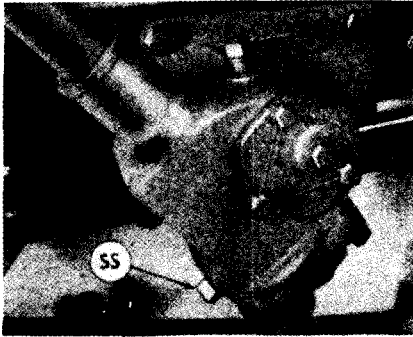
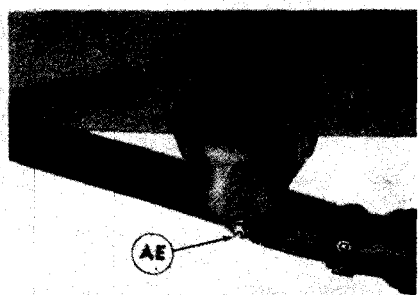
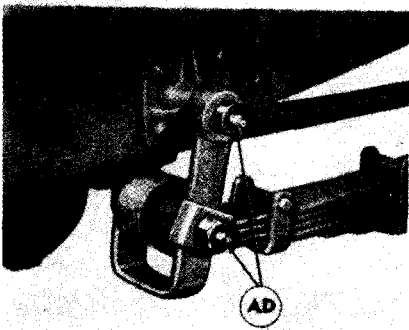
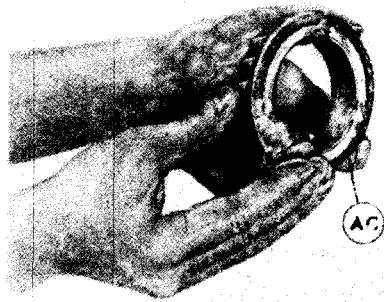
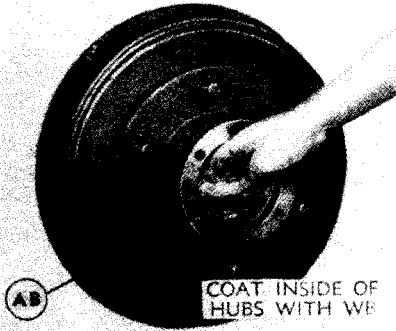
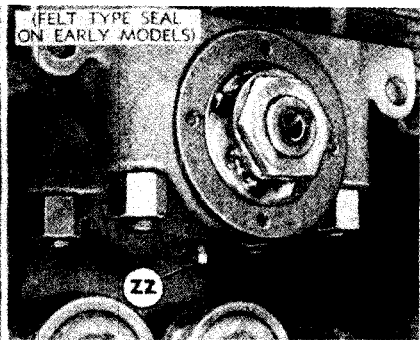
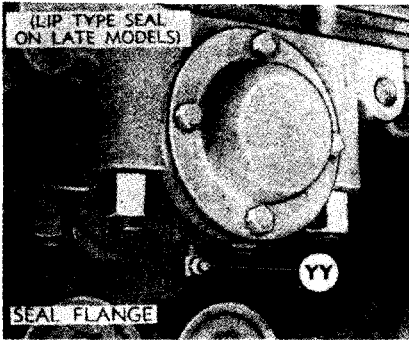

Figure 53. Lubrication localized views.



Note. See note 16, LO 9-801 (fig. 47), and note 10, LO 9-U315 (fig. 47.2).
Figure 54. Lubrication localized views.



RA PD 333041G

Figure 55. Lubrication localized views.

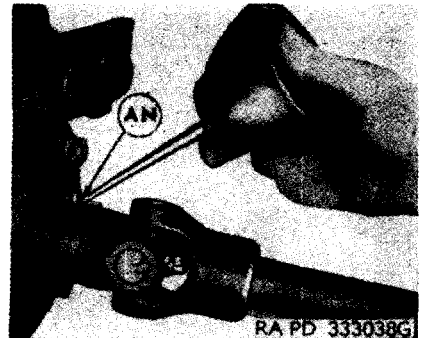
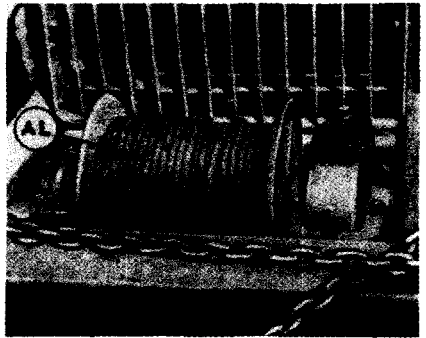
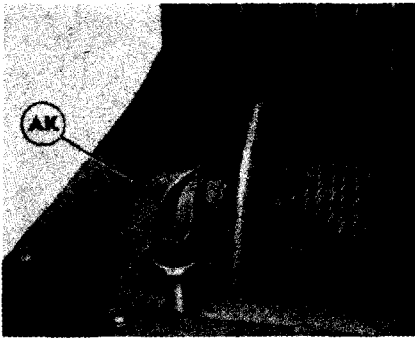
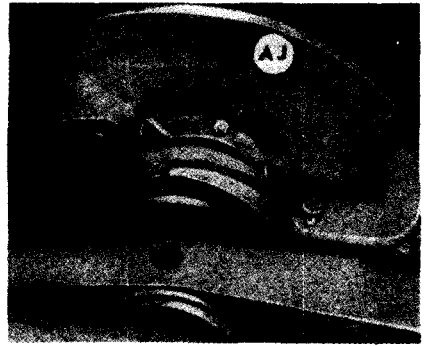
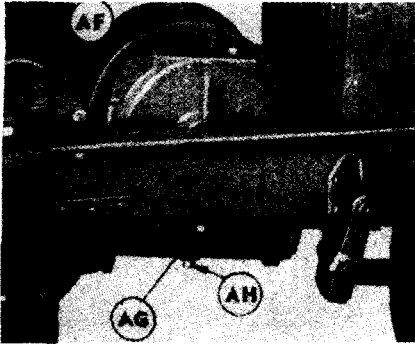

Figure 56. Lubrication localized views

38. Purpose

a. When a new * * * and correctly adjusted. In addition, they will perform a run-in test of at least 50 miles according to procedures in paragraph 40.

40. Run-In Test Procedures

a. PRELIMINARY SERVICE.

* * * * *

(26) *Tools and equipment.*

(a) (Superseded.) *Tools and equipment.* Check tools and on-vehicle stowage against latest edition of Department of the Army Supply Catalog ORD 7 SNL G-508 to be sure all required items are present. See that they are serviceable and properly mounted or stowed.

(b) *Equipment. Rescinded.*

* * * * *

c. VEHICLE PUBLICATIONS AND REPORTS.

(1) *Publications* (superseded). See that the vehicle operator's manual, lubrication order, Standard Form 91 (Operator's Report of Motor Vehicle Accident), WD AGO Form 478 (MWO and Major Unit Assembly Replacement Record and Organization Equipment File), are in the vehicle, legible, and properly stowed.

Note. Department of the Army registration number and vehicle nomenclature must be filled in on Form 478 for new vehicles.

* * * * *

Section X. PREVENTIVE MAINTENANCE SERVICES

41. General

(Superseded.)

a. RESPONSIBILITY AND INTERVALS. Preventive maintenance services are the responsibility of the using organization. These services consist generally of before-operation, during-operation, at-the-halt, after-operation, and weekly services performed by the driver or operator and the scheduled services to be performed at designated intervals by organization mechanic or maintenance crews. Intervals are based on normal operations. Reduce intervals for abnormal operations or severe conditions. Intervals during inactive periods may be extended accordingly.

b. DEFINITION OF TERMS. The general inspection of each item applies also to any supporting member or connection, and generally is

a check to see whether the item is in good condition, correctly assembled, secure, and not excessively worn.

- (1) The inspection for "good condition" usually is an external visual inspection to determine whether the unit is damaged beyond safe or serviceable limits. The term "good condition" is explained further by the following: not bent or twisted, not chafed or burned, not broken or cracked, not bare or frayed, not dented or collapsed, not torn or cut, not deteriorated.
- (2) The inspection of a unit to see that it is "correctly assembled" usually is an external visual inspection to see whether or not it is in its normal assembled position in the vehicle.
- (3) Inspection of a unit to determine if it is "secure" usually is an external visual examination or a wrench, hand-feel, or a pry-bar check for looseness. Such an inspection must include any brackets, lock washers, lock nuts, locking wires, or cotter pins used.
- (4) By "excessively worn" is meant worn beyond serviceable limits, or to a point likely to result in failure if the unit is not replaced before the next scheduled inspection.

42. Cleaning

(Superseded.)

a. GENERAL. Any special cleaning instructions required for specific mechanisms or parts are contained in the pertinent section. General cleaning instructions are as follows:

- (1) Use dry-cleaning solvent or volatile mineral spirits paint thinner to clean or wash grease or oil from all parts of the vehicle.
- (2) A solution of one part grease-cleaning compound to four parts of dry-cleaning solvent or volatile mineral spirits paint thinner may be used for dissolving grease and oil from engine blocks, chassis, and other parts. After cleaning, use cold water to rinse off any solution which remains.
- (3) Use clean water or a soap solution of $\frac{1}{4}$ pound of soap chips to a gallon of hot water for all rubber parts and over-all general cleaning of painted surfaces.
- (4) After the parts are cleaned, rinse and dry them thoroughly. Take care to keep the parts clean.
- (5) Remove the protective grease coating from new parts, since this grease is usually not a good lubricant.

b. GENERAL PRECAUTIONS IN CLEANING.

- (1) Dry-cleaning solvent (Stoddard type) and volatile mineral spirits paint thinner are inflammable and should not be used near an open flame. Fire extinguishers should be provided when these materials are used. In addition, they evaporate quickly and have a drying effect on the skin. If used without gloves, they may cause cracks in the skin and, in the case of some individuals, a mild irritation or inflammation. Use only in well ventilated places.
- (2) Avoid getting petroleum products such as dry-cleaning solvent, mineral spirits paint thinner, engine fuels, or lubricants on rubber parts as they will deteriorate the rubber.
- (3) The use of gasoline or benzene for cleaning is prohibited.

43. Preventive Maintenance by Driver or Operator

(Superseded.)

a. PURPOSE. To insure mechanical efficiency, it is necessary that the vehicle be systematically inspected at intervals each day it is operated and weekly, so defects may be discovered and corrected before they result in serious damage or failure. Certain scheduled maintenance services will be performed at these designated intervals. Any defects or unsatisfactory operating characteristics beyond the scope of the driver or operator to correct, must be reported at the earliest opportunity to the designated individual in authority. The services set forth in table II are those performed by the driver or operator before-operation, during-operation, at-the-halt, after-operation, and weekly.

b. USE OF DD FORM 110. Driver or operator preventive maintenance services are listed on the back of DD Form 110 (Vehicle and Equipment Operational Record) (par. 2). Items listed on the form that do not pertain to this vehicle are eliminated from the procedures as written in this manual. Every organization must thoroughly school its personnel in performing the maintenance procedures set forth in this manual, whether they are listed specifically on DD Form 110 or not.

c. SERVICES. Table II lists the services to be performed by the driver or operator at the designated intervals.

Table II. Driver's or Operator's Preventive Maintenance Services

| Intervals | | | | | Procedure |
|------------------|------------------|-------------|-----------------|--------|--|
| Before-operation | During-operation | At-the-halt | After-operation | Weekly | |
| X | ----- | X | X | X | <p>(1) <i>Fuel, oil, and water.</i> Check the amount of fuel in the tanks and note any indications of leaks. Add fuel if necessary and check the spare fuel containers. Check the oil level and add oil if necessary. Check water level in the cooling system and note any leaks. When water is added during period that antifreeze is in use, a hydrometer test must be made and antifreeze added, if necessary, to provide safe operation to meet lowest anticipated temperature.</p> <p>Caution: Place all tags describing condition of vehicle in the driver's compartment in a conspicuous location so that they will not be overlooked.</p> |
| X | ----- | X | X | X | <p>(2) <i>Tires.</i></p> <p>(a) All tires should be properly inflated and spares properly secured in their carriers (par. 218).</p> <p>(b) Remove all foreign matter such as nails, glass, or stones from tires and from between duals. Examine tires for signs of low pressure, abnormal tread wear, cuts, and presence of valve caps. All tires with cuts extending to or into the cord body or worn smooth in center of tread or which show abnormal tread wear must be reported to proper authority for corrective action.</p> |
| ----- | ----- | ----- | X | X | |
| ----- | ----- | ----- | ----- | X | <p>(c) Check tires for proper matching and irregular wear and change position as required. Check wheel nuts and ring bolts for proper tightness.</p> |
| X | ----- | X | ----- | X | <p>(3) <i>Leaks, general.</i> Check under the vehicle and in engine compartment for any indication of fuel, oil, or brake fluid leaks.</p> |
| X | ----- | X | X | X | <p>(4) <i>Visual inspection of equipment.</i> Determine if lamps and reflector, horn, fire extinguishers, mirrors, paulins, tools, etc., are in the proper place and in good operating order. Check for any tampering or damage that might have occurred prior to inspection.</p> |
| X | X | ----- | ----- | ----- | <p>(5) <i>Instruments.</i> With the engine running, check all instruments for normal readings.</p> |

Table II. Driver's or Operator's Preventive Maintenance Services—Continued

| Intervals | | | | | Procedure |
|------------------|------------------|-------------|-----------------|--------|---|
| Before-operation | During-operation | At-the-halt | After-operation | Weekly | |
| | X | | | | (6) <i>Operating observations.</i> While the vehicle is in operation, the driver or operator should be alert for any sounds that may be a sign of trouble, such as rattles, knocks, squeaks, or hums. The instruments should be checked and any unusual reading noted which would indicate any part of the vehicle or powered ground equipment functioning improperly. Every time the brakes are used, gears shifted, or the vehicle turned, the driver or operator should instinctively consider it a test and note any unusual or unsatisfactory performance. |
| | | | X | | (7) <i>Clean equipment.</i> (a) Clean dirt and trash from inside cab and body. Clean glass and, when practicable, wipe off exterior of equipment. |
| | | | | X | (b) Wash the vehicle when possible. If not possible, wipe off thoroughly. Thoroughly clean engine and engine compartment of all excess dirt, trash, fuel, and oil drippings. |
| | | | | X | (8) <i>Battery.</i> Clean and add necessary water. Check terminal connections to see that they are securely fastened and properly coated with grease. |
| | | | | X | (9) <i>Assemblies and belts.</i> Check all assemblies such as carburetor, generator, regulator, starter, and water pump for loose connections or mountings. Check adjustment of fan and drive belts (par. 108). If found to be improperly adjusted, report to the proper authority. |
| | | | | X | (10) <i>Electrical wiring.</i> Check all accessible wiring and ascertain that it is securely connected and supported, that insulation is not cracked or chafed, and that conduits and shielding are in good condition and secure. Report any unserviceable wiring. |
| | | | X | X | (11) <i>Tools and equipment</i> Check to see that all tools and equipment are serviceable and in their proper place. Clean tools and equipment weekly. |
| | | | | X | (12) <i>Fuel filters.</i> Remove the drain plug or sediment bowl and remove all water and sediment from the filter (par. 98). |

Table II. Driver's or Operator's Preventive Maintenance Services—Continued

| Intervals | | | | | Procedure |
|------------------|------------------|-------------|-----------------|--------|--|
| Before-operation | During-operation | At-the-halt | After-operation | Weekly | |
| ----- | ----- | ----- | X | X | (13) <i>Lights</i> . Observe whether the lights operate properly. Inspect all lenses and warning reflectors for dirt or damage; clean if necessary. |
| ----- | ----- | ----- | X | X | (14) <i>Horn and windshield wipers</i> . Test horn for proper operation. Test windshield wipers to insure proper functioning and cleaning action. |
| ----- | ----- | ----- | ----- | X | (15) <i>Towing connections</i> . Weekly inspect towing hooks, pintle hook, and safety chains for looseness or damage. Clean and lubricate as required and inspect for abnormal wear. Test to be sure that latching mechanism closes completely and latches securely. |
| ----- | ----- | ----- | ----- | X | (16) <i>Springs and suspensions</i> . Check springs for abnormal sag, broken or shifted leaves, loose or missing rebound clips, eye-bolts, "U" bolts, or shackles. Also check shock absorbers, radius rods, and any torque rods to see that they are not damaged. |
| ----- | ----- | ----- | ----- | X | (17) <i>Axle and transfer vents</i> . Check and clean all axle housings and transfer vents to see that they are in good condition and secure. Free all breather vents of obstructions. |
| ----- | ----- | ----- | ----- | X | (18) <i>Publications</i> . Check to see that all appropriate publications concerning the operation and maintenance of the equipment are on hand and in good order. |
| ----- | ----- | ----- | X | X | (19) <i>Lubrication as needed</i> . Lubricate equipment in accordance with instructions contained in Lubrication Orders, LO 9-801 and 9-U315. |

44. At-Halt Service

Rescinded. See paragraph 43 and table II.

45. After-Operation and Weekly Services

Rescinded. See paragraph 43 and table II.

46. Second Echelon Preventive Maintenance

a. Regular scheduled maintenance * * * of operating organizations.

(5) *Specific procedures.* The procedures for * * * indicated opposite number.

| 6,000 mile maint (six- month) | 1,000 mile maint (monthly) | ROAD TEST |
|-------------------------------------|----------------------------------|--|
| | | * * * * * |
| | 19 | <p><i>Valve mechanism (clearance, lubrication, cover gaskets).</i> Adjust valve clearance * * * indicates a necessity. Correct clearances are: intake 0.012, and exhaust 0.016 inch (or 0.020 inch on engines with late type camshafts (par. 77c)), at operating temperature. Be sure bond * * * and tightly connected.</p> |
| 19 | | <p><i>Adjust.</i> Adjust clearances. Intake 0.012 inch, exhaust 0.016 inch (or 0.020 inch on engines with late type camshafts (par. 77c)), at operating temperature. Check for minimum clearance of 0.040 inch between intake valve spring upper retainer (cap) and oil shield (par. 77c). Examine valve push * * * unserviceable cover gasket.</p> <p style="text-align: center;">* * * * *</p> |
| | | TOOLS AND EQUIPMENT |
| 131 | 131 | <p><i>Tools (vehicle and pioneer).</i> Inspect all the standard vehicle and pioneer tools to see that they are all present (Department of the Army Supply Catalog ORD 7 SNL G-508), in good condition, clean, and properly stowed or securely mounted. Also examine the * * * glare, or reflection.</p> <p style="text-align: center;">* * * * *</p> |
| 135 | 135 | <p><i>Publications and Form 91.</i> The vehicle and equipment manuals, lubrication order, Standard Form 91 (Accident-Report Form), WD AGO Form 478 (MWO and Major Unit Assembly Replacement Record) must be present, legible, and properly stowed.</p> <p style="text-align: center;">* * * * *</p> |

51. Engine Miscellaneous Operating Faults

* * * * *

b. EXCESSIVE OIL CONSUMPTION.

* * * * *

(7) (Added.) Excessive oil consumption may result from loss of oil through ventilator air cleaner. If top of cleaner element (fig. 68) is dry, the oil is being lost from the cleaner reservoir as a result of splashing caused by operation over extremely rough terrain. Maintain the cleaner reservoir oil level at the full mark (sec. VIII). If the top of cleaner element is wet with oil, the loss is from the engine crankcase, internal pressure forcing the oil out. To correct loss of oil due to internal pressures, perform the following inspections and corrections and *note all cautions*:

- (a) Adjust governor (par. 96e).
- (b) Do not exceed permissible road speeds in any gear (fig. 19). Do not overspeed while going downhill.
- (c) Inspect crankcase oil level after engine has been stopped for a few minutes while vehicle is in level position. If oil level is above full mark, drain excess (par. 17b).
- (d) Disassemble and clean ventilator valve (par. 82). If valve spring is distorted or damaged, replace valve assembly.
- (e) Be sure ventilator air cleaner oil level is correct (sec. VIII). The relation of the cleaner element to the oil level in the reservoir is correct when the bottom of the element reaches, but is not below, the top of the oil level.
- (f) Inspect for and correct any oil leaks at the rocker arm cover, push rod cover, and ventilator tube fittings (fig. 69). If the rocker arm cover is of the louver type, be sure that the closures are in place and that they do not leak.
- (g) Engine blow-by past pistons into crankcase may exceed flow of air through ventilator valve, allowing pressure to be built up in the crankcase. If the capacity of the ventilator valve is too low to handle this increased pressure, the engine will have to be overhauled. Notify ordnance maintenance personnel.

* * * * *

65. Transfer Case

a. HARD SHIFTING (GMC CCKW-352 AND 353 ONLY).

* * * * *

b. SLIPS OUT OF GEAR (GMC CCKW-352 AND 353 ONLY).

* * * * *

75. Description and Tabulated Data

* * * * *

b. TABULATED DATA.

* * * * *

(2) Adjustment data.

Valve clearance (hot)

| | | |
|---|-------|-----------|
| Intake | ----- | 0.012 in. |
| Exhaust (with early type camshaft GM-2136000) | | 0.016 in. |
| Exhaust (with late type camshaft GM-2191529) | | 0.020 in. |

* * * * *

77. Valve Clearance and Adjustment

* * * * *

c. ADJUST VALVE CLEARANCE (superseded).

(1) Valve stem. With engine hot and idling, insert feeler gage (0.012 inch for intake and 0.016 or 0.020 inch for exhaust) between rocker arm and valve stem at each valve. (Adjust exhaust valve clearance to 0.016 inch on engines having the early type camshaft installed. Adjust exhaust valve clearance to 0.020 inch on engines having the late type camshaft installed. The late type camshaft can be identified by the GM part number 2191529 stamped on the shaft between number 1 intake and number 2 exhaust cams and by the dark colored cams in contrast to the highly polished cams of the early type shaft.

Note. If there is any doubt as to whether the camshaft in an engine is of the late type, adjust exhaust valve clearance to 0.020 inch.

Using tool similar to that illustrated in figure 58, or a wrench and screwdriver, loosen rocker arm ball stud nut, and tighten or loosen stud until proper clearance is obtained. Tighten nut and recheck clearance.

(2) Spring upper retainer (cap) and oil shield. Check clearance between the intake valve spring upper retainer (cap) and the oil shield (fig. 58.1) with a spark-plug gap gage, bending the 0.040-inch wire to fit. If clearance is less than 0.040 inch, refer to ordnance maintenance for correction. A minimum clearance of 0.040 inch must be maintained between the retainer and shield to insure proper action of the valve locks. Clearance less than 0.040 inch will, when the valve is opened, cause the oil shield to press on the upper retainer. This will

loosen the locks in the retainer, causing the locks to batter against the tapered hole during valve action. The locks may fall out or cause enough wear to pull through the retainer and, in either case, drop the valve into the combustion chamber. The retainer currently in use is thicker and heavier than the original and is rounded to provide more clearance between retainer and oil shield.

Note. Insufficient clearance may be corrected by selective replacement of spring upper retainer and locks.

* * * * *

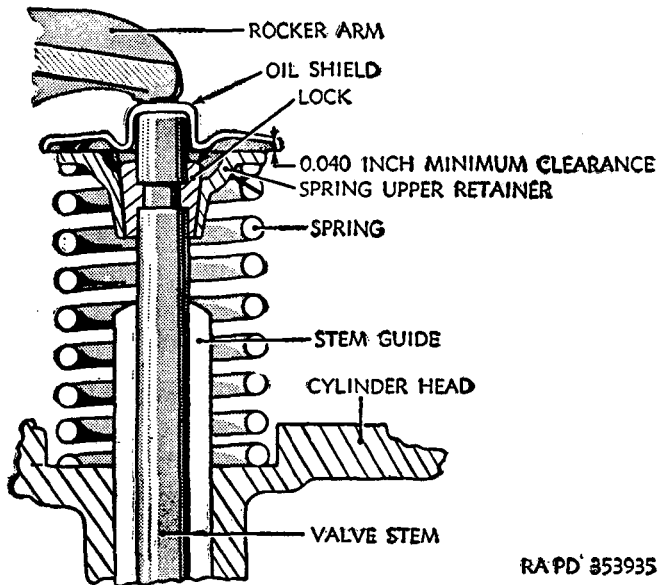

Figure 58.1 (added). Intake valve assembly.

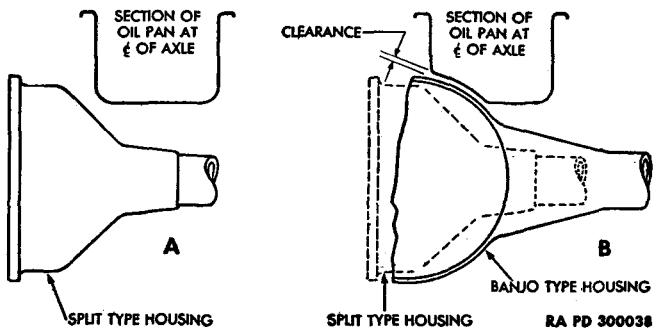

Figure 64.1 (added). Clearance at oil pan for banjo-type axle.

80. Oil Pan

a. DESCRIPTION. The deep sump * * * will damage cleaner. Two types of oil pans are used because of the split-type and banjo-type axle housings that have been installed (par. 163). The first type (GM-2135413) has a plain bottom (A, fig. 64.1) and can be used only with the split-type axle housing. The second type oil pan (GM-2136263) has a depression on the front, right side to provide clearance for the banjo-type axle housing (B, fig. 64.1). This second type oil pan can be used with either of the two types of axle housings.

* * * * *

99. Air Cleaner

* * * * *

f. INSTALLATION (FLANGE MOUNTED AIR CLEANER). If unit to * * * at proper level.

- (1) *Install cleaner.* Place cleaner tube * * * and tighten snugly. Check for 1-inch minimum clearance between air cleaner and radiator tie rod. Bend tie rod to obtain proper clearance. After bending adjust tie rod at dash so that there is $\frac{3}{4}$ -inch clearance between fan blades and radiator (fig. 100).

109. Radiator Assembly

* * * * *

e. (Added.) U-BOLT TYPE RADIATOR MOUNTING. To overcome the difficulty caused by the inaccessible location of the carriage type radiator lower support bolt (fig. 100), which made tightening of the nuts and adjustment at the springs very difficult, a U-bolt type mounting was used in later production vehicles and is provided for service purposes. Installation of the U-bolt type mounting is shown in figure 100.1. Adjustment of the nuts and springs is accomplished in a similar manner as for the carriage bolt type installation (*d* above).

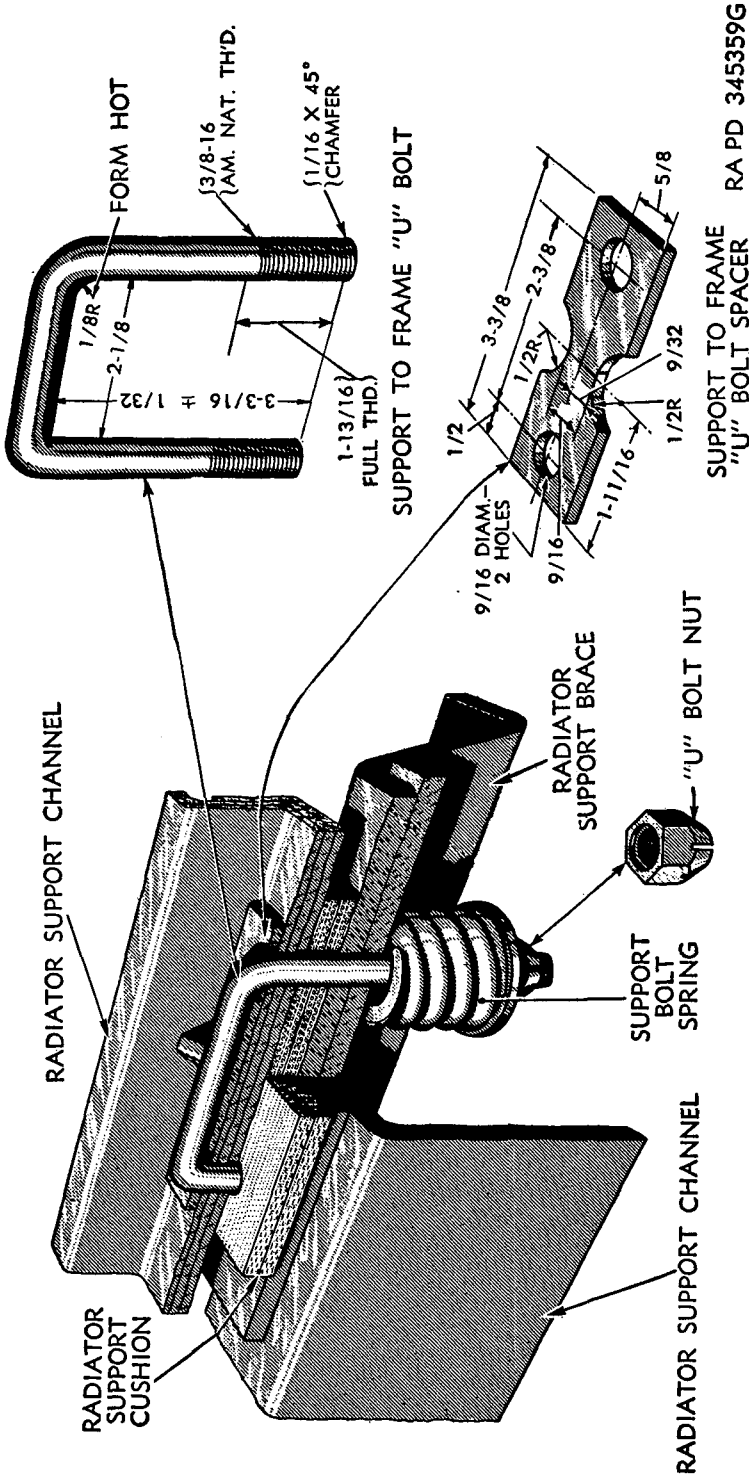

Figure 100.1 (added). Installation of "U"-bolt type radiator mounting.

116. Description

* * * * *

b. (Added.) Various combinations of generators, generator regulators, pulleys, and fan belts have been installed in these vehicles or are available for service. The major difference between the various combinations is in the current capacity; 25-ampere, 30-ampere, or 40-ampere output combinations being used. The current capacities of the generator and regulator on a vehicle must be matched.

118. Regulator

* * * * *

c. REGULATOR INSTALLATION (fig. 106).

* * * * *

(2) *Connect wires.* Install wires on * * * "GROUND" terminal—No 14—black. **A change was made in the location of the three terminals on the latest type sealed regulator.**

Caution: When installing the latest type sealed regulators, the changed terminal locations must be kept in mind to avoid the possibility of improper connection of cables.

* * * * *

159. Description

(Superseded.)

The transfer case is essentially an auxiliary unit consisting of a case, gears, and output shafts for transferring power to each of the driving axles. The transfer case is located between the frame side rails just behind the transmission and is driven by the transmission through a propeller shaft. It is attached to brackets under the transfer case cross member by cap screws.

a. GMC CCKW-352 AND 353. The transfer case has two speed ranges and output shafts to the two rear axles and the front axle. Shifting of transfer case gears is accomplished manually through levers in the cab (par. 16).

b. GMC CCW-353. The transfer case has only one speed range and output shafts to the rear axles, hence, there are no transfer case controls or linkages.

160. Controls and Linkage (CCKW-352 and 353 only)

* * * * *

161. Transfer Case Removal

* * * * *

b. DISCONNECT CONTROL RODS (CCKW-352 AND 353 ONLY) (fig. 144 or 145).

* * * * *

162. Transfer Case Installation

* * * * *

e. CONNECT CONTROL RODS (CCKW-352 AND 353 ONLY) (fig. 144 or 145).

* * * * *

168. Front Axle Removal (GMC CCKW-352 and 353 only)

* * * * *

168.1 Front Axle Removal (GMC CCW-353 only)

(Added.)

a. POSITION VEHICLE. Place vehicle on a level surface and apply hand brake to prevent vehicle from rolling. Jack up front end of vehicle until tires are 3 inches from ground. Place a suitable jack stand on each side of frame just behind front spring rear hanger bracket. Lower front end until weight rests on jack stands. Leave jack raised high enough to support axle assembly.

b. REMOVE WHEELS. Remove wheel stud nuts and remove wheel and tire assembly from each side.

c. DISCONNECT SHOCK ABSORBER LINKS. Disconnect both front shock absorber links at upper spring clip plates.

d. DISCONNECT DRAG LINK. Disconnect drag link at axle steering arm (par. 207).

e. DISCONNECT FLEXIBLE BRAKE HOSE. Turn off the front wheel (brake) shut-off cock inside of right-hand frame rail (fig. 185). Loosen connections at frame side rails; then remove hoses from wheel cylinders.

f. DISASSEMBLE SPRING-TO-AXLE MOUNTING. Remove nuts from spring "U" bolts and remove "U" bolts.

g. REMOVE AXLE ASSEMBLY. Lower jack until axle assembly clears underside of chassis and withdraw from under vehicle.

169. Front Axle Installation (GMC CCKW-352 and 353 only)

* * * * *

169.1 Front Axle Installation (GMC CCW-353)

(Added.)

a. POSITION AXLE ASSEMBLY. Place axle assembly on jack and move it into approximate position under vehicle. Raise axle assembly into position against springs, being certain spring center bolt heads enter alignment holes in axle spring seats.

b. ASSEMBLE SPRING-TO-AXLE MOUNTING. Place spring "U" bolts in position and tighten nuts evenly.

c. CONNECT FLEXIBLE BRAKE HOSE. Install flexible hoses in wheel cylinders and tighten connections at frame side rails. Turn front wheel (brake) shut-off cock, on.

d. CONNECT DRAG LINK. Refer to paragraph 207 for instructions on installing and adjusting drag link on steering arm ball.

e. CONNECT SHOCK ABSORBER LINK. Connect shock absorber links to upper spring plates.

f. INSTALL WHEELS. Install wheel and tire assemblies on hubs, install wheel stud nuts, and tighten firmly.

g. REMOVE JACK STANDS AND JACK. Raise front of vehicle with jack and remove stands from under frame side rails. Lower jack and withdraw from under vehicle. Check all nuts on spring mounting bolts for tightness with full weight of vehicle resting on springs.

h. BLEED BRAKES. Bleed front wheel brakes (par. 180).

i. LUBRICATE. Check lubrication of complete axle assembly as instructed in section VIII.

178.1 Trailer Brake Controller

(Added.)

a. DESCRIPTION. Some 2½-ton 6 x 6 trucks are equipped with a hydraulically operated controller for electric trailer brakes. The controller consists of the following two units:

(1) *Load control.* The load control which is mounted on the dash (fig. 17.1) is a manually operated variable resistance wired in series with the hydraulically operated brake controller. It is equipped with a dial to vary the severity of brake application on the trailer (par. 15g).

(2) *Brake controller.* The brake controller is connected to the hydraulic brake system of the truck to permit uniform application of truck and trailer brakes by the use of the load control variable resistance and the brake pedal. The brake controller (fig. 162.1) is mounted on the rear of the first cross member to the rear of cab on left side and is connected into the hydraulic brakes on the truck.

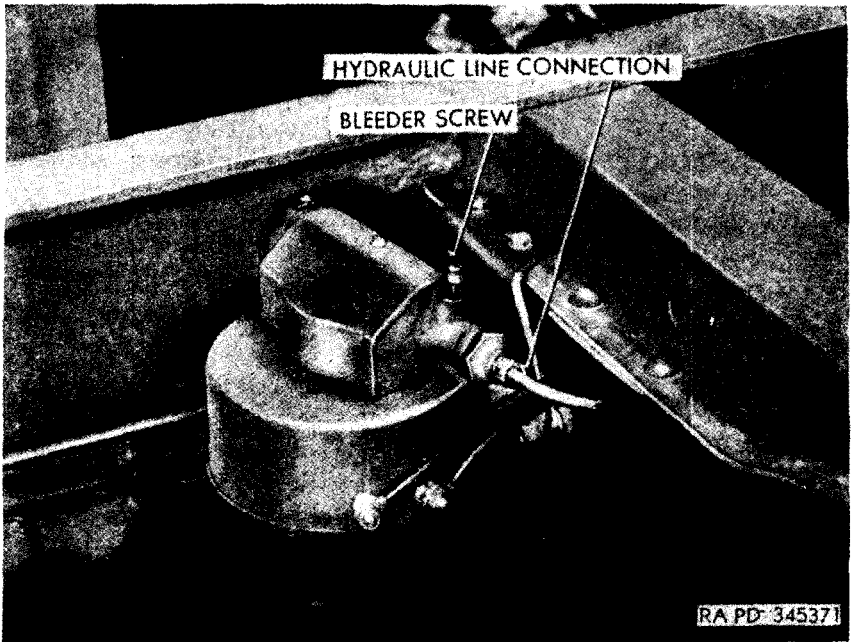

Figure 162.1. Brake controller mounted on cross member.

b. OPERATION OF BRAKE CONTROLLER.

- (1) The line pressure enters the actuating assembly at (T) (fig. 162.2) and is carried into the cylinder which has a rubber piston cup (K). As the line pressure is increased by brake pedal pressure, piston (P) pushes against spring (G). Attached to the piston is yoke (N) which actuates the contact lever. The assembly is also equipped with a bleeder screw (A).
- (2) The piston travels about one-eighth inch before the spring (G) starts to compress. The spring is compressed still further before the hydraulic brakes on the tractor take effect. This amount of travel of the piston operates the controller sufficiently to start application of the trailer brakes before the tractor brakes are applied.

c. ADJUSTMENT.

- (1) If it should be desirable to apply the trailer brakes further in advance of the tractor brakes, adjustment nut (B) can be unscrewed one to two turns.

Caution: Two turns is the most that the nut should be unscrewed.

- (2) When bleeding operations are necessary, bleed all wheel cylinders first, then bleed the hydraulic electric trailer brake control cylinder at bleeder screw (A, fig. 162.2).

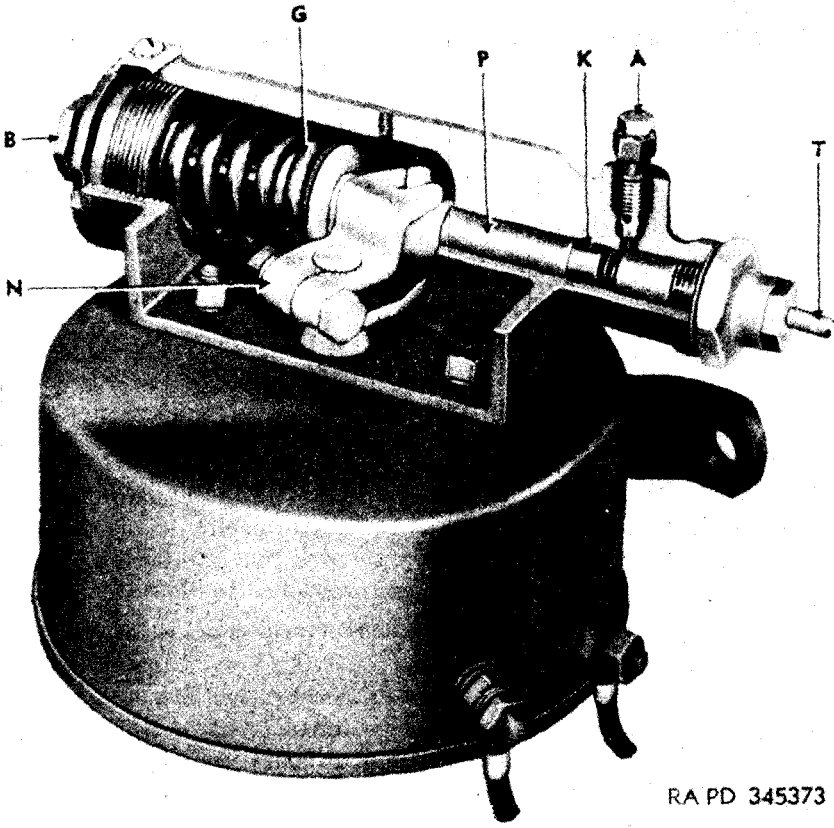

RA PD 345373

Figure 162.2. Cut-away section showing hydraulic actuating assembly of brake controller.

199. Wheel Bearing Adjustment

* * * * *

c. FRONT HUB BEARING ADJUSTMENT.

(1) *Banjo-type axles* (fig. 196).

(a) Remove drive flange * * * from outer nut. With wrench (41-W-3748-100), furnished with vehicle (use notched end), remove outer nut. Remove nut lock.

* * * * *

(2) *Split-type axles* (fig. 197).

(a) Remove drive flange * * * from outer nut. With hex end of adjusting wrench (41-W-3825-100), remove outer nut. Remove nut lock.

* * * * *

Page 463—The material contained in the appendix (pars. 250–255) is superseded by part four and the appendix following:

PART FOUR

SHIPMENT AND LIMITED STORAGE AND DESTRUCTION TO PREVENT ENEMY USE

Section XLV. SHIPMENT AND LIMITED STORAGE

250. Domestic Shipping Instructions

a. **PREPARATION.** When shipping the 2½-ton 6 x 6 and 6 x 4 trucks interstate or within the zone of interior, the officer in charge of preparing the shipment *will be responsible* for furnishing vehicles to the carriers for transport in a serviceable condition, properly cleaned, preserved, painted, lubricated, etc., as prescribed in SB 9-4.

Note. For loading and blocking instructions of vehicles on freight cars, refer to paragraphs 252 and 253.

b. **REMOVAL OF PRESERVATIVES FOR SHIPMENT.** Personnel withdrawing vehicles from a limited storage status for domestic shipment *must not remove preservatives* other than to insure that they are complete and serviceable. The removal of preservatives is the responsibility of depots, ports, or field installations (posts, camps, and stations) receiving the shipments.

c. **ARMY SHIPPING DOCUMENTS.** Prepare all Army shipping documents accompanying freight in accordance with TM 38-705.

251. Limited Storage Instructions

a. **GENERAL.**

- (1) Vehicles received already processed for domestic shipment as indicated on the Vehicle Processing Record Tag (WD AGO Form 9-3), need not be reprocessed unless the inspection performed on receipt of vehicles reveals corrosion, deterioration, etc.
- (2) Completely process vehicles if the processing data recorded on the tag indicates that vehicle has been rendered ineffective by operation, freight shipping damage, or upon receipt of vehicles directly from manufacturing facilities.
- (3) Vehicles to be prepared for limited storage must be given a limited technical inspection and the results and classification of vehicle will be entered on the Limited Technical Inspection sheet (DA AGO Form 461-5) as prescribed in SB 9-63.

b. RECEIVING INSPECTIONS.

- (1) Report of vehicles received in a damaged condition or improperly prepared for shipment will be made on the Report of Damaged or Improper Shipment sheet (DD Form 6) in accordance with SR 745-45-5.
- (2) When vehicles are inactivated, they are to be placed in a limited storage status for periods not to exceed 90 days. Stand-by storage for periods in excess of 90 days normally will be handled by ordnance maintenance personnel only.
- (3) Immediately upon receipt of vehicles, they must be inspected and serviced as prescribed in section XI. Perform a systematic inspection and replace or repair all missing or broken parts. If repairs are beyond the scope of the unit and the vehicle will be out-of-service for an appreciable length of time, place vehicle in a limited storage status and attach a tag to the vehicle specifying the repairs needed. The report of these conditions will be submitted by the unit commander for action by an ordnance maintenance unit.

c. INSPECTIONS DURING STORAGE. Perform a visual inspection periodically to determine general condition. If corrosion is found on any part, remove the rust spots, clean, paint, and treat with the prescribed preservatives.

Note. Touch-up painting will be in accordance with TM 9-2851.

d. REMOVAL FROM LIMITED STORAGE.

- (1) If the vehicles are not shipped or issued upon expiration of the limited storage period, they must be further treated for stand-by storage (for periods in excess of 90 days up to 3 years) by ordnance maintenance personnel.
- (2) If vehicles to be shipped will reach their destination within the scope of the limited storage period, they need not be reprocessed upon removal from storage unless inspection reveals it to be necessary.
- (3) Deprocess vehicles when it has been ascertained that they are to be placed into immediate service. Remove all rust preventive compounds and thoroughly lubricate as prescribed in section VIII. Inspect and service vehicles as prescribed in section XI.
- (4) Repair and/or replace all items tagged in accordance with *b*(3) above.

e. STORAGE SITE. The preferred type of storage for vehicles is under cover in open sheds or warehouses whenever possible. Where it is found necessary to store vehicles outdoors, they must be protected against the elements as prescribed in SB 9-47.

252. Loading the 2¹/₂-Ton 6 x 6 and 6 x 4 Trucks for Rail Shipment

a. PREPARATION.

- (1) When vehicles are shipped by rail, every precaution must be taken to see that they are properly loaded and securely fastened and blocked to the floor of car. All "on-vehicle matériel" (OVM) will be thoroughly cleaned, preserved, packed, and securely stowed in or on the vehicle during transit.
- (2) Prepare all vehicles for rail shipment in accordance with paragraph 250a. In addition take the following precautions:
 - (a) Disconnect the truck battery to prevent its discharge by vandalism or accident. This is accomplished by disconnecting the positive lead, taping the end, and tying it back away from the battery.
 - (b) Apply the truck hand brake and place the transmission in neutral position after the vehicle has been finally spotted on the freight car. The vehicles must be loaded on the car in such a manner as to prevent the car from carrying an unbalanced load.
 - (c) Increase tire pressure slightly higher than normal except in cases where shipment is to be exposed to extremely hot weather conditions.

b. TYPE OF CARS. Instructions contained herein pertain to the loading of vehicles in gondola cars (an open top car having fixed sides, fixed or drop ends, and solid bottom) and flatcars (cars with wooden floors laid over sills and without sides or ends but equipped with stake pockets).

c. METHOD OF LOADING VEHICLES ON FREIGHT CARS.

(1) Flatcar loading.

- (a) When suitable hoisting equipment is not available for loading vehicles on or subsequent unloading from a flatcar, an end ramp must be used in cases where the vehicle is not on a level with the flatcar deck. Vehicles on a warehouse platform or loading dock can be pivoted over spanning platforms aboard a flatcar spotted adjacent to the platform, then again pivoted into lateral position on the flatcar.
- (b) When unboxed vehicles must be loaded from ground level, a ramp may be improvised ((3) below) by borrowing railroad ties normally found stacked in railroad yards and by procuring necessary planking. An ideal end loading ramp is shown in place in figure 258.

Note. Railroad ties alone, stacked without deck planking and not securely anchored, provide a very unstable ramp and must be rearranged upon each successive use. The torque action of the wheels of self-propelled vehicles will tend to collect and collapse a simple

stack of railroad ties and should, therefore, not be attempted except under conditions of extreme emergency.

- (c) To load vehicles, the vehicles are towed onto the improvised apron at base of ramp and unhitched. Using a cable laid along the center line of the flatcar, attached to vehicle, the vehicle is pivoted to point toward the ramp.

Caution: Follow up forward movement of the vehicle by chocking behind one wheel on the ramp.

- (d) After the first vehicle is loaded on the flatcar, additional vehicles may be similarly hauled aboard by passing the towing cable beneath the loaded vehicle. When a train of flatcars is being loaded, steel or wooden spanning platforms or bridges are used to cover the gap between cars. Flatcar brake wheels must first be lowered to floor level to permit passage. A pair of improvised spanning platforms are shown in place in figure 259. These spanning platforms are moved along the train by hand as the vehicle advances.
- (e) The above method of train loading requires careful advance planning as to the order of loading, so that vehicles are arranged on each flatcar under prescribed methods and combinations.
- (f) For powering the towing cable, a vehicle with winch is spotted at *right angles* to the train, located at about the third or fourth flatcar to facilitate signaling and because of cable length limits. A single-sheave snatch block located between cars on the train center line will provide the necessary *lateral* pull. Vehicles passing this point can be towed by a vehicle on the ground with personnel guiding its passage. A long tow cable from the towing vehicle will lessen the trend of the vehicle to stray from the center line of the train.

Note. The snatch block fastening chain must be lashed to an adjacent object or stake to offset the cross pull of the powered winch (fig 260). Block movement is allowed for low *front* winches and high rear (wrecker) winches.

(2) *Gondola car loading.*

- (a) Fixed-end type gondola cars may be loaded only when hoisting facilities are available for initial loading and for unloading at destination. Hopper- or drop-bottom gondolas are not to be used for shipments of unboxed vehicles without false flooring.
- (b) Drop-end gondola cars may be loaded exactly as described for flatcars ((1) above). Height of fixed sides is immaterial. Vehicles may progress through a gondola car by passing over the two inwardly dropped ends and over spanning

| PART NO | QUANT | REQ'D | PART NAME | LENGTH | WIDTH | THICKNESS |
|---------|----------|-------|------------------------------------|----------|--------|-----------|
| 1 | 8 | | RAMP FLANGES | 80 ft. | 10 in. | 3 in. |
| 2 | 2 | | GUIDE RAILS | 80 ft. | 8 in. | 3 in. |
| 3 | 2 | | TIE STRIPS | 78 ft. | 8 in. | 3 in. |
| 4 | 2 | | CLEATS | 18 in. | 6 in. | 2 in. |
| 5 | 2 | | CLAY | 24 in. | 8 in. | 2 in. |
| 6 | 31 | | RAILROAD TIES | 8 ft. | 8 in. | 4 in. |
| 7 | AS REQ'D | | FILLERS | AS REQ'D | 8 in. | 8 in. |
| 8 | AS REQ'D | | WEDGES (CUT TO FIT) | AS REQ'D | 10 in. | 5 in. |
| 9 | 1 | | STEPPDOWN PLATE | 8 ft. | 4 in. | 4 in. |
| 10 | 1 | | STEPPDOWN PLATE | 8 ft. | 6 in. | 2 in. |
| 11 | 8 | | CHOCK BLOCKS | 8 ft. | 6 in. | 1 in. |
| 12 | AS REQ'D | | STRINGERS | AS REQ'D | 10 in. | 4 in. |
| 13 | AS REQ'D | | GROUND DRAINAGE | AS REQ'D | 10 in. | 3 in. |
| 14 | AS REQ'D | | PORTABLE WOODEN SPANNING PLATFORMS | AS REQ'D | 10 in. | 3 in. |

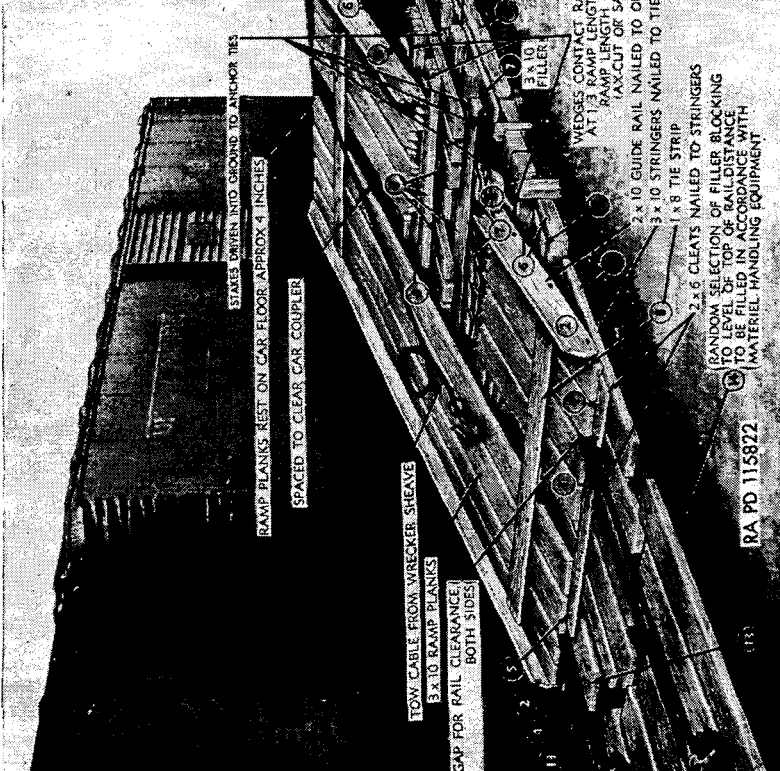

LOWERED BRAKE WHEEL
 PORTABLE WOODEN SPANNING PLATFORMS
 (1) 1 x 2
 (2) 2 x 4
 (3) CAR CHOCKS JAMMED IN PLACE AHEAD AND BEHIND TWO PAIRS OF WHEELS

SAW-CUT RAILROAD TIES, RANDOM LENGTHS, WHEN ONLY ADZECUT, CROOKED TIES ARE AVAILABLE, LEVEL EACH LAY WITH WEDGE BLOCKING.

NOTES: 1. RAMP SHOWN IS OF CAPACITY OF LARGEST END-LOADING FREIGHT CAR. FOR LESSER LOADS, REDUCE NUMBER OF RAMP PLANKS.
 2. WIDTH DETERMINED BY TREAD OF MATERIAL BEING LOADED.
 3. FOR LOADING TWO WHEELED ARTILLERY TRAILERS OR SHORT WHEELBASE MATERIAL, RAMP PLANKS MAY BE SHORTER.
 -CAUTION: WHEN RAMP IS TOO SHORT, UNDERPINNING OF MATERIAL WILL STRIKE END OF RAMP (EX. 90 MM AA GUN).
 4. OPENING AT CENTER MAY BE FILLED UP TO THE CAR COUPLER TO AVOID INJURY TO MANEUVERING PERSONNEL.
 5. FOR LOADS OVER 40 TONS, APPROACH END OF FLATCAR MUST BE BLOCKED UP TO AVOID TIPPING OF FLATCAR.
 6. THIS TYPE RAMP IS ADAPTABLE TO DROP-END GONDOLA AND AUTO END-DOOR BOX CAR LOADING.
 7. WHEN LOADING AN AUTO END-DOOR BOX CAR, IT MAY BE NECESSARY TO LOAD A FLATCAR COUPLED TO THE BOX CAR TO GAIN OVERHEAD LOADING CLEARANCE.
 8. WHEN LOADING BY WRECKER CABLE WITH PULL AT 90 DEGREES TO TRAIN, USING A SHEAVE FLATCAR AT POINT OF PULL MUST BE LASHED TO ADJACENT RAILS CAR, OR OTHER FIXED OBJECT.

STAKES DRIVEN INTO GROUND TO ANCHOR TIES
 RAMP PLANKS REST ON CAR FLOOR APPROX. 1 INCHES SPACED TO CLEAR CAR COUPLER
 TOW CABLE FROM WRECKER SHEAVE
 GAP FOR RAIL CLEARANCE BOTH SIDES
 3 x 10 RAMP PLANKS
 3 x 10 STRINGERS NAILED TO TIES
 3 x 10 FILLER
 WEDGES CONTACT RAMP PLANKS AT 1/3 RAMP LENGTH AND 2/3 RAMP LENGTH POINTS (AX-CUT OR SAWED)
 2 x 10 GUIDE RAIL NAILED TO OUTER PLANK
 3 x 10 STRINGERS NAILED TO TIES
 1 x 8 TIE STRIP
 2 x 6 CLEATS NAILED TO STRINGERS
 RANDOM SECTION OF FILLER BLOCKING TO LOCAL SECTION OF RAMP TO BE FILLED IN ACCORDANCE WITH MATERIAL HANDLING EQUIPMENT

RA PD 115822

Figure 258. Construction of improvised loading ramp.

platforms. Vehicles selected to remain in a gondola car are first moved to the *closed* end of the car, then spread out for blocking after the remaining end is closed and latched.

Note. Do not block vehicle flush against ends of gondola car. When ordering gondola cars, specify inside width required as some may be received with gussets along the inner sides which affect clearance.

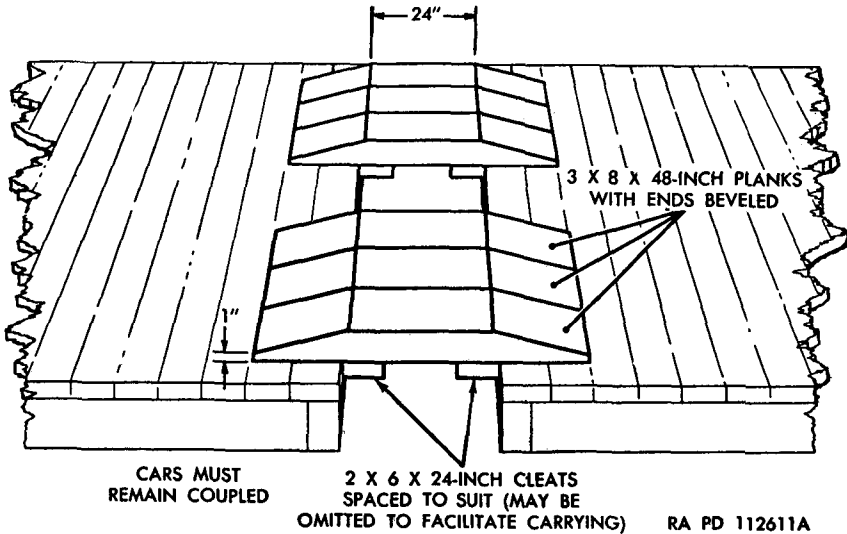

Figure 259. Construction of improvised spanning platforms.

(3) *Loading ramp.*

- (a) A ramp for end-loading of vehicles on open-top freight cars may be improvised when no permanent ramps or hoisting facilities are available. An ideal ramp suitable for the loading of most ordnance items is shown in figure 258. For loading the 2½-ton 6 x 6 and 6 x 4 trucks, the width of the ramp may be reduced to two double-plank runways, each cleated together. Length of planking must be determined with consideration to under-chassis clearance, in order to clear the hump at upper end of ramp.

Caution: Personnel guiding the vehicle up the ramp must exercise care when working close to the edges of the ramp planking.

- (b) The flatcar bearing the ramp must be securely blocked against rolling, particularly when the car brakes are not applied as in train loading. Successive cars must remain coupled and be additionally chocked at several points along the train when ground towing of vehicles aboard the train is being effected.

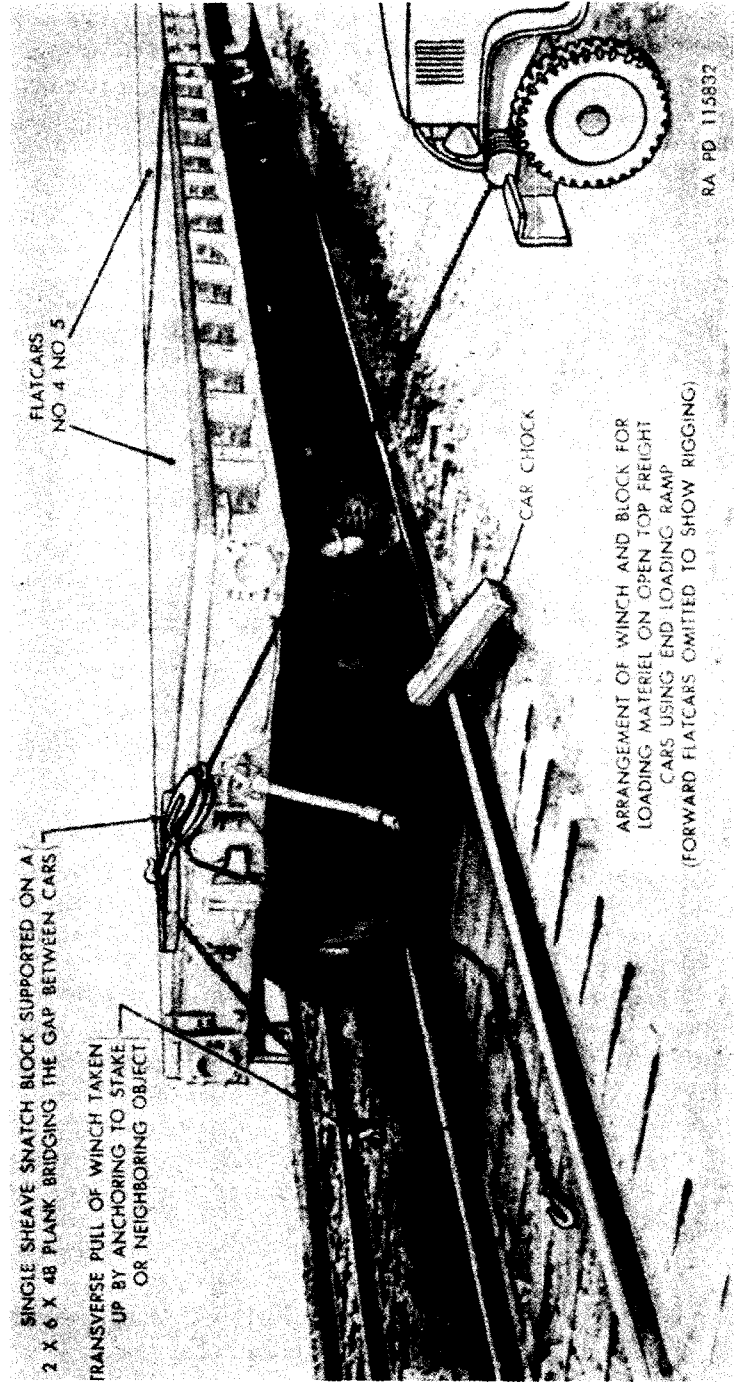

Figure 260. Method of powering the towing cable.

- (c) Whenever the freight cars are not on an isolated track or blocked siding, each end approach to the train must be placarded (blue flag or light) to advise that men are at work and that the siding may not be entered beyond those points.
- (d) Upon completion of the loading operation, the ramp planks and bridging devices should be loaded on the train for use in unloading operations. Random sizes of timbers used in building the approach apron up to rail level should be included. All materials should be securely fastened to the car floors after vehicles are blocked in place and entered upon the bill of lading. Railroad ties borrowed for the operation need not be forwarded to the unloading point unless specifically required and only with the consent of the owner.

d. **LOADING RULES.** For general loading rules pertaining to rail shipment of ordnance vehicles, refer to TB 9-OSSC-G.

253. Blocking the 2½-Ton 6 x 6 and 6 x 4 Trucks for Rail Shipment

a. **GENERAL.** All blocking instructions specified herein are minimum and are in accordance with the Association of American Railroads "Rules Governing the Loading of Commodities on Open Top Cars." Additional blocking may be added as required at the discretion of the officer-in-charge. Double-headed nails may be used if available, except in the lower piece of two-piece blocking. All item reference letters given below refer to the details and locations as shown in figure 261. The truck shown is not the GMC truck but method of blocking is applicable.

Note. Any loading methods or instructions developed by any source which appear in conflict with this publication or existing loading rules of the carriers, must be submitted to the Chief of Ordnance, Washington 25, D. C., for approval.

b. **BRAKE WHEEL CLEARANCE "A."** Load trucks on cars with a minimum clearance of at least 4 inches below and 6 inches above, behind, and to each side of the brake wheel (fig. 261). Increase clearance as much as is consistent with proper location of load.

Note. Vehicle should be spotted on flatcar so that wheels are centered between stake pockets in order that wheel strapping "G" (*h* below) provides uniform cross wiring.

c. **CHOCK BLOCKS "B" (6 x 8 x 24-IN; 12 REQUIRED PER TRUCK).** Locate the 45° face of blocks against the front and rear of front wheels, in front of intermediate wheels, and in back of rear wheels. Blocks are to be positioned in such a manner as to allow flush application of wheel side cleats "D" (*e* below) when nailed to chock blocks. Nail heel of blocks to car floor with three forty-penny nails and toenail sides of blocks to car floor with two forty-penny nails each.

Note. Chock blocks may be cut from timber (or railroad ties when available) as shown in figure 262.

d. CUSHIONING MATERIAL "C" (fig. 261). Locate suitable cushioning material such as waterproof paper, burlap, etc., between tires and cleats "D." The cushioning material must protrude beyond cleats "E" at floor and above cleats "D."

e. WHEEL SIDE CLEATS "D" (FRONT WHEELS 1 x 8 x 59-IN; REAR WHEELS 1 x 8 x 103-IN; TWO OF EACH REQUIRED). Locate cushioning material (*d* above) against tires and locate and nail cleats to chock blocks "B" with four tenpenny nails at each end.

f. FLOOR SIDE CLEATS "E" (FRONT WHEELS 2 x 4 x 35-IN; REAR WHEELS 2 x 4 x 79-IN; FOUR OF EACH REQUIRED).

Note. Four shorter double cleats may be used in lieu of the long ones specified for rear wheels. Locate one pair on vertical center line of each rear and intermediate wheel.

Locate two floor side cleats against each wheel side cleats "D" with cushioning material protruding underneath. Nail lower cleats to car floor with four thirtypenny nails at front wheels and ten thirtypenny nails at rear wheels. Nail upper cleats to lower cleats and car floor with four forty penny nails at front wheels and ten forty penny nails at rear wheels.

g. CROSS CLEATS "F" (2 x 4-IN; LENGTH TO SUIT, FOUR REQUIRED PER TRUCK). Locate two cleats across the top of the front chock blocks (front of wheels) and two cleats across the rear chock blocks (rear of wheels). Nail lower cleats to the top of chock blocks with two thirtypenny nails at each end. Nail upper cleats to the lower cleats and top of chock blocks with two forty penny nails, staggered at each end.

h. WHEEL STRAPPING "G" (NO. 8 GAGE BLACK ANNEALED WIRE, LENGTH TO SUIT).

Note. For gondola car loading wheel strapping will not be required.

- (1) *Front wheels.* Pass one wire (consisting of four strands, twist-tied together) through ventilating hole at upper part of front wheel slightly *forward* of center and out through adjacent ventilating hole. Attach to stake pocket *rearward* of front wheel, bringing both ends of wire together. Twist-tie and tighten with rod or bolt just taut enough to remove all slack. Pass one wire (consisting of four strands twist-tied together) through ventilating hole at upper part of front wheel slightly *rearward* of center and out through adjacent ventilating hole crossing initial wires. Attach to stake pocket *forward* of front wheel bringing both ends of wire together. Twist-tie and tighten with rod or bolt just taut enough to remove all slack. Repeat above operations for the other front wheel.

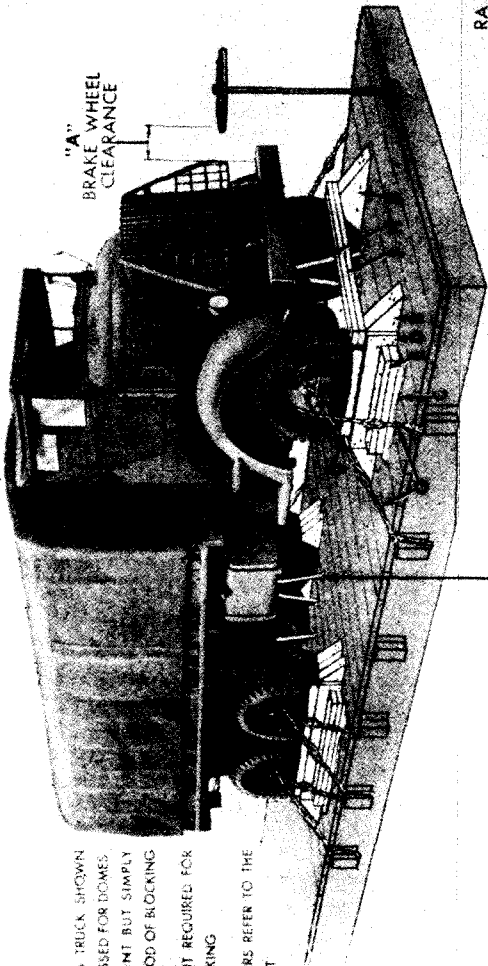

NOTE 1--THE 2 1/2-TON 6 X 6 TRUCK SHOWN HAS NOT BEEN PROCESSED FOR DOMESTIC FREIGHT SHIPMENT BUT SIMPLY ILLUSTRATES THE METHOD OF BLOCKING.

2--WHEEL STRAPPING NOT REQUIRED FOR CONDOULA CAR BLOCKING.

3--ITEM REFERENCE LETTERS REFER TO THE DESCRIPTIONS IN TEXT.

RA PD 115831

| | | |
|---|---|---|
| <p>WELL-TYPE STAKE POCKET LASHING 2 X 4 X 18-IN CLEAT</p> | <p>BOTTOM SURFACE OF PLATE ANCHOR PLATE FIRST POSITION FINAL POSITION</p> | <p>ALTERNATE METHOD OF STRAPPING AXLES TO CAR FLOOR</p> |
|---|---|---|

Figure 261. Method of blocking 2 1/2-ton 6 x 6 and 6 x 4 trucks for rail shipment.

- (2) *Rear wheels.* Each outside intermediate and rear wheel will be crosswired to stake pocket as prescribed for the front wheels ((1) above) (fig. 261).

Note. Wires are passed through stake pockets in a manner that the wire loop lays against the car frame. A short stake driven into the stake pocket will protect the wire loop from chafing and loosening. (This stake is omitted in fig. 261.) When flatcars are received which are provided with well-type stake pockets, a loop of strapping wire is passed through the stake pocket and a short piece of wood about 2 x 4 x 18 inches is inserted in the loop, below the stake pocket. Subsequent tightening of the strapping will cause the wire to draw the wooden block securely against the bottom of stake pocket.

i. **AXLE STRAPPING "H."** Locate two pieces of 1-inch No. 14 BW gage hot-rolled steel strapping over each axle (close to brakes) and coil around steel anchor plates as shown in figure 261. Secure by nailing anchor plates to car floor with not less than six twentypenny nails (double-headed nails preferred). As an alternate method of securing axles, substitute a wire "J" (consisting of four strands of No. 8 gage black annealed wire or wires of equivalent strength) at each location for steel strapping "H." Pass wires over axle and around wooden cleats "K" (2 x 4 x 18-in). Locate cleats lengthwise of car and nail to car floor with four thirtypenny nails in each cleat. Bring both ends of wires together and twist taut with rod or bolt just enough to take up slack (fig. 261).

254. Oversea Shipment

a. **INSPECTION STANDARDS.** All used vehicles destined for oversea use will be inspected prior to shipment to determine their serviceability in accordance with standards given in SB 9-2.

b. **PREPARATION FOR SHIPMENT TO PORTS.** All vehicles destined to ports of embarkation for oversea shipment that have already been processed for domestic shipment (par. 250) will be further processed in accordance with SB 9-4.

Note. Ports of embarkation will supplement any necessary additional or previously omitted processing upon receipt of vehicle for oversea shipment.

Section XLVI. DESTRUCTION OF MATÉRIEL TO PREVENT ENEMY USE

255. General

a. Destruction of the vehicle, when subject to capture or abandonment in the combat zone, will be undertaken by the using arm only when, in the judgment of the unit commander, such action is necessary in accordance with orders of, or policy established by, the army commander.

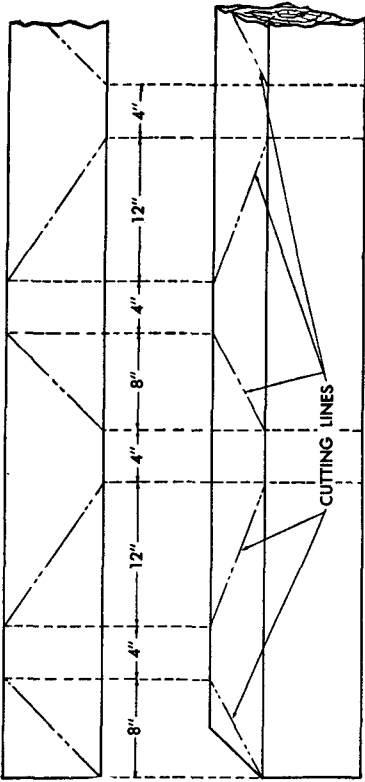

METHOD OF MARKING TIMBER
FOR CUTTING CHOCK BLOCKS

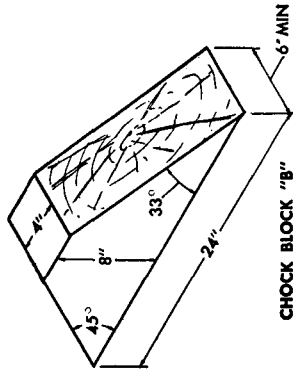

NOTE: RAILROAD TIES MAY BE SUBSTITUTED
FOR TIMBERS WHEN AVAILABLE

RA PD 115824

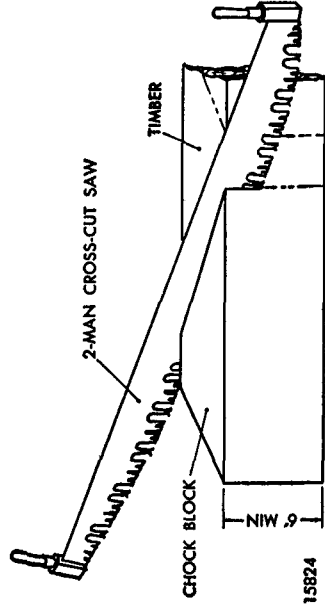

Figure 262. Cutting chock blocks from timbers.

b. The information which follows is for guidance only. Certain of the procedures outlined require the use of explosives and incendiary grenades which normally may not be authorized items for the vehicle. The issue of these and related materials, and the conditions under which destruction will be effected, are command decisions in each case, according to the tactical situation. Of the several means of destruction, those most generally applicable are—

Mechanical—Requires ax, pick mattock, sledge, crowbar, or similar implement.

Burning —Requires gasoline, oil, incendiary grenades, or other inflammables.

Demolition —Requires suitable explosives or ammunition.

Gunfire —Includes artillery, machine guns, rifles using rifle grenades, and launchers using antitank rockets. Under some circumstances hand grenades may be used.

In general, destruction of essential parts, followed by burning, usually will be sufficient to render the matériel useless. However, selection of the particular method of destruction requires imagination and resourcefulness in the utilization of the facilities at hand under the existing conditions. Time usually is critical.

c. If destruction to prevent enemy use is resorted to, the matériel must be so badly damaged that it cannot be restored to a usable condition in the combat zone either by repair or cannibalization. Adequate destruction requires that all parts essential to the operation of the matériel, including essential spare parts, be destroyed or damaged beyond repair. However, when lack of time and personnel prevents destruction of all parts, priority is given to the destruction of those parts most difficult to replace. Equally important, the same essential parts must be destroyed on all like matériel so that the enemy cannot construct one complete unit from several damaged ones.

d. If destruction is directed, due consideration should be given to—

- (1) Selection of a point of destruction that will cause greatest obstruction to enemy movement and also prevent hazard to friendly troops from fragments or ricocheting projectiles which may occur incidental to the destruction.
- (2) Observance of appropriate safety precautions.

256. Detailed Instructions

a. METHOD No. 1—BY BURNING.

- (1) Remove and empty portable fire extinguishers.
- (2) Puncture fuel tanks as near the bottom as possible, collecting gasoline for use as outlined in (6) below.

- (3) Using an ax, pick, sledge, or other heavy implement, smash all vital elements such as distributor, carburetor, generator, ignition coil, fuel pump, spark plugs, air cleaner, lights, instruments, and controls. If time permits, and a sufficiently heavy implement is available, smash the engine cylinder block and head, crankcase, and transmission.
 - (4) Slash tires. If tires are inflated, exercise care to prevent injury should the tire blow out while being slashed. Whenever practicable, it is usually preferable to deflate tires before slashing.
 - (5) Remove ammunition from packing or other protective material. Place ammunition in and about the vehicle so that it will be fully exposed to the fire and in such locations that the greatest damage will result from its detonation. Remove any safety devices from ammunition.
 - (6) Pour gasoline and oil in and over the entire vehicle—ignite and take cover. Elapsed time: About 6 minutes.
- b. METHOD NO. 2—WITH DEMOLITION MATERIALS.
- (1) Remove and empty portable fire extinguishers.
 - (2) Puncture fuel tank.
 - (3) Prepare two 2-pound charges of EXPLOSIVE, 'TNT' (two 1-lb blocks or equivalent per charge). Set the charges as follows:

- (a) One on top of the clutch housing.
- (b) The second, as low on the left side of the engine as possible. Connect the two charges for simultaneous detonation with detonating cord. Provide for dual priming to minimize the possibility of a misfire. For priming, either a non-electric blasting cap crimped to at least 5 feet of safety fuse (safety fuse burns at the rate of 1 foot in 30 to 45 seconds) or an electric blasting cap and firing wire may be used. Safety fuse, which contains black powder, and blasting caps must be protected from moisture at all times. The safety fuse may be ignited by a fuse lighter or a match; the electric blasting cap requires a blasting machine or equivalent source of electricity.

Caution: Keep the blasting caps, detonating cord, and safety fuse separated from the charges until required for use.

Note. For the successful execution of methods of destruction involving the use of demolition materials, all personnel concerned will be thoroughly familiar with the provisions of FM 5-25. Training and careful planning are essential.

- (4) Destroy the tires by placing an incendiary grenade under each tire. The detonation of the explosive charges should be delayed until the incendiary fires are well started. This

will prevent the fires from being extinguished by the blast when the charges are detonated.

- (5) Detonate the charges. If primed with nonelectric blasting cap and safety fuse, ignite and take cover. If primed with electric blasting cap, take cover before firing. Elapsed time: About 6 minutes.

c. METHOD No. 3—BY GUNFIRE.

- (1) Remove and empty portable fire extinguishers.
- (2) Puncture fuel tanks.
- (3) Destroy the tires as in method No. 1 (*a* above)
- (4) Destroy the vehicle by gunfire using artillery, machine guns, rifles using rifle grenades, or launchers using antitank rockets. Fire on the vehicle aiming at the engine, axles, and wheels. Although one well-placed direct hit may destroy the vehicle, several hits are usually required for complete destruction unless an intense fire is started, in which case the vehicle may be considered destroyed. Elapsed time: About 6 minutes.

Caution: Firing at ranges of 500 yards or less should be from cover.

d. METHOD No. 4—MECHANICAL. Using an ax, pick, sledge, or any other heavy object, smash all vital elements, such as distributor, carburetor, air cleaner, generator, ignition coil, fuel pump, spark plugs, lights, instruments, and controls. If time permits, and a sufficiently heavy object is available, smash the engine cylinder block and head, crankcase, transmission, and axles. Slash and destroy tires

APPENDIX

REFERENCES

1. Publication Indexes

The following publication indexes and lists of current issue should be consulted frequently for latest changes or revisions of references given in this appendix and for new publications relating to matériel covered in this manual:

- a.* Index of Administrative Publications.... SR 310-20-5
- b.* Index of Army Motion Pictures and Film Strips. SR 110-1-1
- c.* Index of Army Training Publications.... SR 310-20-3
- d.* Index of Blank Forms and Army Personnel Classification Tests. SR 310-20-6
- e.* Index of Technical Manuals, Technical Regulations, Technical Bulletins, Supply Bulletins, Lubrication Orders, Modification Work Orders, Tables of Organization and Equipment, Reduction Tables, Tables of Allowances, Tables of Organization, Tables of Equipment, and Tables of Basic Allowances. SR 310-20-4
- f.* Introduction and Index (supply catalogs). ORD 1
- g.* Military Training Aids..... FM 21-8

2. Supply Catalogs

The following catalogs of the Department of the Army Supply Catalog pertain to this matériel:

- a.* AMMUNITION.
Ammunition, Rifle, Carbine, and Automatic Gun. ORD 11 SNL T-1
- b.* ARMAMENT.
Gun, Machine, Cal. .30, Browning, M1919A4, Fixed and Flexible; M1919A5, Fixed; and M1919A6; and Ground Mounts. ORD (*) SNL A-6
Gun, Machine, Cal. .50, Browning, M2, Heavy Barrel, Fixed and Flexible; and Ground Mounts. ORD (*) SNL A-39
- c.* MAINTENANCE AND REPAIR.
Antifriction Bearings and Related Items.... ORD 5 SNL H-12
Cleaners, Preservatives, Lubricants, Recoil Fluids, Special Oils, and Related Maintenance Materials. ORD 3 SNL K-1

(*) See ORD 1, Introduction and Index, for published catalogs of the ordnance section of the Department of the Army Supply Catalog.

| | |
|---|------------------------------|
| Items of Soldering, Metallizing, Brazing, and Welding Materials; Gases and Related Items. | ORD 3 SNL K-2 |
| Lubricating Equipment, Accessories, and Related Dispensers. | ORD (*) SNL K-3 |
| Major Items of Automotive and Semiautomotive Vehicles. | ORD 3 SNL G-1 |
| Miscellaneous Hardware..... | ORD 5 SNL H-2 |
| Oil Seals..... | ORD 5 SNL H-13 |
| Ordnance Maintenance Sets..... | ORD 6 SNL N-21 |
| Standard Hardware..... | ORD 5 SNL H-1 |
| Tool-sets (Common), Specialists' and Organizational. | ORD 6 SNL G-27, Section 2 |
| Tool-sets for Maintenance of Small Caliber Automatic and Semiautomatic Ground and Aircraft Weapons. | ORD 6 SNL A-35, Section 1 |
| Tool-sets (Special), Motor Vehicles..... | ORD 6 SNL G-27, Section 1 |

d. VEHICLE.

| | |
|--|-------------------|
| Truck, 2½-ton, 6 x 6 (GMC Models CCKWX-353, CCKW-352, 353, and AFKWX-353); Truck, 2½-ton, 6 x 4 (GMC Model CCW-353); and Truck, Bomb Service, M27. | ORD (*) SNL G-508 |
|--|-------------------|

3. Explanatory Publications

The following explanatory publications contain information pertinent to this matériel and associated equipment.

a. AMMUNITION.

| | |
|--|--------------|
| Allocation and Distribution of Training Ammunition and Explosives within the Zone of Interior. | SR 710-60-50 |
| Ammunition: General..... | SB 9-AMM-1 |
| Ammunition: General..... | TM 9-1900 |
| Explosives and Demolition..... | FM 5-25 |
| Regulations for Firing Ammunition for Training, Target Practice, and Combat. | SR 385-310-1 |
| Reports of Accident Experience..... | SR 385-10-40 |
| Small Arms Ammunition..... | SB 9-AMM-4 |
| Small Arms Ammunition..... | TM 9-1990 |

b. ARMAMENT.

| | |
|---|----------|
| Browning Machine Gun, Cal. .50, HB, M2... | FM 23-65 |
| Browning Machine Guns, Cal. .30, M1917A1, M1919A4, and M1919A6. | FM 23-55 |
| US Rifle, cal. .30, M1..... | FM 23-5 |

(*) See ORD 1, Introduction and Index, for published catalogs of the ordnance section of the Department of the Army Supply Catalog.

c. CAMOUFLAGE.

| | |
|-----------------------------------|----------|
| Camouflage..... | TM 5-267 |
| Camouflage, Basic Principles..... | FM 5-20 |
| Camouflage of Vehicles..... | FM 5-20B |

d. DECONTAMINATION.

| | |
|---|----------|
| Decontamination..... | TM 3-220 |
| Decontamination of Armored Force Vehicles.. | FM 17-59 |
| Defense Against Chemical Attack..... | FM 21-40 |

e. GENERAL.

| | |
|---|------------|
| Automotive Brakes..... | TM 10-565 |
| Automotive Power Transmission Units..... | TM 10-585 |
| Chassis, Body, and Trailer Units..... | TM 10-560 |
| Cooling Systems: Vehicles and Powered Ground Equipment. | TM 9-2858 |
| Dictionary of United States Army Terms.... | TM 20-205 |
| Driver Selection, Training, and Supervision, Wheeled Vehicles. | TM 21-300 |
| Driver's Manual..... | TM 21-305 |
| Fuels and Carburetion..... | TM 10-550 |
| General Safety Manual..... | TM 20-350 |
| General Supply: Winterization Equipment for Automotive Matériel. | SB 9-16 |
| Hand, Measuring, and Power Tools..... | TM 10-590 |
| Lubrication..... | TM 9-2835 |
| Military Vehicles..... | TM 9-2800 |
| Modification of Ordnance Matériel..... | SB 9-38 |
| Motor Transport..... | FM 25-10 |
| Motor Vehicles..... | AR 700-105 |
| Mountain Operations..... | FM 70-10 |
| Operation in Snow and Extreme Cold..... | FM 70-15 |
| Precautions in Handling Gasoline..... | AR 850-20 |
| Principles of Automotive Vehicles..... | TM 9-2700 |
| Registration of Motor Vehicles..... | AR 850-10 |
| Storage Batteries Lead-Acid Type..... | TM 9-2857 |

f. MAINTENANCE AND REPAIR.

| | |
|---|-----------|
| Basic Maintenance Manual..... | TM 38-650 |
| Cleaning, Preserving, Sealing, and Related Materials Issued for Ordnance Matériel. | TM 9-850 |
| Inspection of Ordnance Matériel..... | TM 9-1100 |
| Instruction Guide: Care and Maintenance of Ball and Roller Bearings. | TM 37-265 |
| Lubrication Order: Truck, 2½-ton, 6 x 6 (GMC Models CCKW-352 and CCKW-353). | LQ 9-801 |
| Lubrication Order: Truck, 2½-ton, 6 x 4 (GMC Model CCW-353). | LO 9-U315 |
| Maintenance and Care of Hand Tools..... | TM 9-867 |

Maintenance and Care of Pneumatic Tires and Rubber Treads. TM 31-200

Motor Vehicle Inspection and Preventive Maintenance Services. TM 37-2810

Painting Instructions for Field Use.----- TM 9-2851

Preparation of Ordnance Matériel for Deep Water Fording. TM 9-2853

g. SHIPMENT AND LIMITED STORAGE.

Army Marking Directive.----- TM 38-414

Army Shipping Document.----- TM 38-705

Instruction Guide: Ordnance Packaging and Shipping (Posts, Camps, and Stations). TM 9-2854

Ordnance Storage and Shipment Chart— Group G. SB 9-OSSC-G

Preparation for Shipment of Unserviceable Transport and Combat Vehicle Major Assemblies. SB 9-26

Preparation of Unboxed Ordnance Matériel for Shipment. SB 9-4

Protection of Ordnance Matériel in Open Storage. SB 9-47

Report of Damaged or Improper Shipment.--- SR 745-45-5

Standards for Oversea Shipment and Domestic Issue of Ordnance Matériel Other Than Ammunition and Army Aircraft. TB ORD 385

Storage, Inspection, and Issue of Unboxed Serviceable Motor Vehicles; Preparation of Unserviceable Vehicles for Storage; and De-processing of Matériel Prior to Operation. SB 9-63

[AG 300.7 (9 Mar 50)]

BY ORDER OF THE SECRETARY OF THE ARMY:

OFFICIAL: J. LAWTON COLLINS
 EDWARD F. WITSELL *Chief of Staff, United States Army*
Major General, USA
The Adjutant General

DISTRIBUTION:

Tech Sv (2) except 9 (25); Arm & Sv Bd (2); AFF (2); OS Maj Comd (10); Base Comd (2); MDW (3); A (20); CHQ (2); D (2); B 5, 6, 44 (1); R 2, 4-8 (1), 9 (2), 10, 11, 17, 19, 55 (1); Bn 2-8 (1), 9 (2), 10, 11, 17, 19, 44, 55 (1); C 2-8 (1), 9 (2), 10, 11, 17, 19, 44, 55 (1); FC (1); Sch (5) except 9 (50); Gen Dep (1); Dep 9 (3); PE (Ord O) (5), OSD (1); PG 9 (3); Ars 9 (3); Dist 9 (3); SPECIAL DISTRIBUTION.

For explanation of distribution formula, see SR 310-90-1.

WAR DEPARTMENT TECHNICAL MANUAL
TM 9-801

This manual, together with TM 9-1801, 10 Mar 1944 and TM 9-1802A, 15 Jul 1944, supersedes TM 10-1105, 18 Jul 1941; TM 10-1147, 26 Aug 1941; TM 10-1253, 8 Oct 1941; TM 10-1269, 19 Jan 1942; TM 10-1501, 12 Jul 1941; and TM 10-1563, 1 Jul 1944. In addition, this manual supersedes TM 9-801, 12 Apr 1943; OFSTB 801-1, 6 Apr 1943; OFSTB 801-4, 24 Jan 1944; OFSTB 10-1147-1, 6 Apr 1943; OFSTB 10-1501, 6 Apr 1943. Also, this manual supersedes the following publications insofar as they apply to this manual. These publications remain in force until such time as they are incorporated in other affected manuals or are specifically rescinded: OFSTB 800-15, 14 Jul 1943; WDTB ORD 13, 12 Jan 1944; WDTB ORD 20, 24 Jan 1944; WDTB ORD 26, 9 Feb 1944; and WDTB ORD 32, 18 Feb 1944.

TRUCK
2½-TON, 6 x 6
GMC CCKW-352 & 353



WAR DEPARTMENT
Washington 25, D.C., 24 April 1944

TM 9-801, 2½-ton 6x6 Truck (GMC CCKW-352 and 353) is published for the information and guidance of all concerned.

[A.G. 300.7 (20 Nov 43)]

BY ORDER OF THE SECRETARY OF WAR:

G. C. MARSHALL,
Chief of Staff.

OFFICIAL:

J. A. ULIO,
Major General,
The Adjutant General.

**DISTRIBUTION: D 7 (5); B 18 (2); R 9 (4); Bn 2,4,5,6,7,8,9,17,
18, 44 (2); C 9 (8); IC 2,4,6,7,8,10,17,18,44 (2).**

(For explanation of symbols, see FM 21-6.)

**TRUCK, 2½-TON, 6 x 6
(GMC CCKW-352 & 353)**

CONTENTS

PART ONE—GENERAL

| SECTION | Paragraphs | Pages |
|---|------------|-------|
| I. Introduction..... | 1-2 | 5-6 |
| II. Description and tabulated data.. | 3-5 | 6-19 |
| III. Tools, parts, and accessories..... | 6-10 | 20-27 |

PART TWO—OPERATING INSTRUCTIONS

| | | |
|--|-------|-------|
| IV. Controls and instruments..... | 11-15 | 28-35 |
| V. Operation under usual conditions | 16-23 | 35-54 |
| VI. Operation of auxiliary equipment | 24-28 | 54-69 |
| VII. Operation under unusual conditions..... | 29-35 | 69-79 |

PART THREE—MAINTENANCE INSTRUCTIONS

| | | |
|--|--------|---------|
| VIII. Lubrication..... | 36-37 | 80-98 |
| IX. New vehicle run-in test..... | 38-40 | 99-103 |
| X. First echelon preventive maintenance service..... | 41-45 | 103-114 |
| XI. Second echelon preventive maintenance..... | 46 | 114-137 |
| XII. Power plant trouble shooting and diagnosis..... | 47-59 | 137-150 |
| XIII. Power train and miscellaneous trouble shooting and diagnosis. | 60-74 | 150-161 |
| XIV. Engine description, data, maintenance, and adjustment on vehicle..... | 75-82 | 161-177 |
| XV. Engine removal and installation. | 83-85 | 178-186 |
| XVI. Ignition system..... | 86-90 | 186-196 |
| XVII. Fuel and air intake system..... | 91-101 | 196-215 |

CONTENTS

| SECTION | Paragraphs | Pages |
|--|------------|---------|
| XVIII. Exhaust system | 102-105 | 215-219 |
| XIX. Cooling system | 106-112 | 220-230 |
| XX. Starting system | 113-115 | 230-233 |
| XXI. Generating system | 116-118 | 233-238 |
| XXII. Battery and lighting system | 119-125 | 238-249 |
| XXIII. Wiring, harnesses, and circuits | 126-128 | 249-260 |
| XXIV. Radio noise suppression system | 129-134 | 260-272 |
| XXV. Instruments, gages, and switches | 135-148 | 272-283 |
| XXVI. Clutch and controls | 149-152 | 284-288 |
| XXVII. Transmission | 153-155 | 288-292 |
| XXVIII. Power take-off and controls | 156-158 | 292-301 |
| XXIX. Transfer case and control | 159-162 | 301-309 |
| XXX. Front axle | 163-169 | 309-320 |
| XXXI. Rear axles | 170-174 | 321-325 |
| XXXII. Propeller shafts, universal joints, and pillow block | 175-177 | 325-329 |
| XXXIII. Service brake system | 178-191 | 329-361 |
| XXXIV. Hand brake system | 192-196 | 361-366 |
| XXXV. Wheels, tires, and hubs | 197-202 | 366-386 |
| XXXVI. Steering system | 203-207 | 386-392 |
| XXXVII. Front and rear spring suspension | 208-213 | 392-403 |
| XXXVIII. Frame | 214-219 | 404-412 |
| XXXIX. Cab and associated parts | 220-224 | 412-418 |
| XL. Sheet metal | 225-228 | 419-424 |
| XLI. Cargo and dump bodies | 229-232 | 424-431 |
| XLII. Gasoline and water tank bodies | 233-234 | 431-440 |
| XLIII. Winch and controls | 235-242 | 440-448 |
| XLIV. Power hoist and controls | 243-249 | 448-463 |

APPENDIX

| | | |
|---|---------|---------|
| XLV. Shipment and temporary storage | 250-252 | 463-469 |
| XLVI. References | 253-255 | 469-471 |
| Index | | 472-480 |

PART ONE—GENERAL

Section I

INTRODUCTION

1. SCOPE.

a. These instructions are published for the information and guidance of the personnel to whom this equipment is assigned. They contain information on the operation and maintenance of the Truck, 2½-Ton, 6x6, GMC CCKW-352 and 353, as well as descriptions of the major units and their functions in relation to the other components of this vehicle.

b. This manual has the following arrangement:

(1) Part One, General, contains description and data. It lists the tools, spare parts, and equipment carried on the vehicle. It also lists organizational special tools for this vehicle.

(2) Part Two, Operating Instructions, contains instructions for the operation of the vehicle with description and location of the controls and instruments.

(3) Part Three, Maintenance Instructions, contains information needed for the performance of the scheduled lubrication and preventive maintenance services, and instructions for maintenance operations which are the responsibility of the using organizations (first and second echelons). Stock numbers in this part were obtained from the Organizational Spare Parts and Equipment List of SNL G-508, 29 December 1943.

(4) The Appendix contains instructions for shipment and temporary storage, and a list of references including standard nomenclature lists, technical manuals, and other publications applicable to the vehicle.

2. RECORDS.

a. Forms and records applicable for use in performing prescribed operations are listed below with brief explanations of each.

(1) STANDARD FORM NO. 26, DRIVER'S REPORT—ACCIDENT, MOTOR TRANSPORTATION. One copy of this form will be kept with the vehicle at all times. In case of an accident resulting in injury or property damage, it will be filled out by the driver on the spot or as promptly as practical thereafter.

(2) WAR DEPARTMENT FORM NO. 48, DRIVER'S TRIP TICKET AND PREVENTIVE MAINTENANCE SERVICE RECORD. This form, properly executed, will be furnished to the driver when his vehicle is dispatched on non-tactical missions. The driver and the official user of the vehicle will complete in detail appropriate parts of this form. These forms need not be issued for vehicles in convoy or on tactical missions. The reverse side of this form contains the driver's daily and weekly preventive maintenance service reminder schedule.

(3) W.D., A.G.O. FORM NO. 478, MWO AND MAJOR UNIT ASSEMBLY REPLACEMENT RECORD. This form will be used by all personnel completing a modification or major unit assembly (engine,

TRUCK, 2½-TON, 6 x 6

transmission, transfer case, and tracks) replacement to record clearly the description of work completed, date, vehicle hours, and/or mileage, and MWO number or nomenclature of unit assembly. Personnel performing the operation will initial in the column provided. Minor repairs, parts, and accessory replacements will not be recorded.

(4) W.D., A.G.O. FORM No. 6, DUTY ROSTER. This form, slightly modified, will be used for scheduling and maintaining a record of vehicle maintenance operations. It may be used for lubrication records.

(5) W.D., A.G.O. FORM No. 461, PREVENTIVE MAINTENANCE SERVICE AND TECHNICAL INSPECTION WORK SHEET FOR WHEELED AND HALF-TRACK VEHICLES. This form will be used for all 1,000-mile (monthly) and 6,000-mile (semi-annual) maintenance services and all technical inspections performed on wheeled or half-track vehicles.

(6) W.D., O.O. FORM No. 7353, SPOT-CHECK INSPECTION REPORT FOR ALL MOTOR VEHICLES. This form may be used by all commanding officers or their staff representatives in making spot-check inspection on all vehicles.

(7) W.D., A.G.O. FORM No. 468, UNSATISFACTORY EQUIPMENT RECORD. This form will be used for reporting manufacturing, design, or operational defects in material with a view to improving and correcting such defects, and for use in recommending modifications of material. This form will not be used for reporting failures, isolated material defects, or malfunctions of material resulting from fair wear and tear or accidental damage, nor for the replacement, repair, or the issue of parts and equipment. It does not replace currently authorized operational or performance records.

(8) W.D., O.O. FORM No. 7370, EXCHANGE PART OR UNIT IDENTIFICATION TAG. This tag, properly executed, may be used when exchanging unserviceable items for like serviceable assemblies, parts, vehicles, and tools.

Section II
DESCRIPTION AND TABULATED DATA**3. DESCRIPTION.**

a. **General.** Vehicles described in this manual are designated as *TRUCK, 2½-ton, 6 x 6, GMC CCKW-352 and 353*. The vehicles are equipped with one driving front axle and two driving rear axles, and six driving wheels. Conventionally mounted open type cab is used on all vehicles with either cargo, cargo-dump, gasoline tank, or water tank body. In addition to special purpose use, depending upon type of body, vehicles may also be used for towing tractors, guns, and other wheeled equipment.

b. General Characteristics.

(1) **POWER PLANT.** Six-cylinder, in-line, valve-in-head engine

DESCRIPTION AND TABULATED DATA

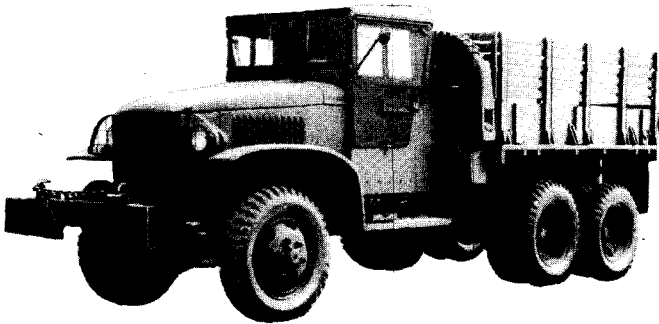

LEFT FRONT VIEW

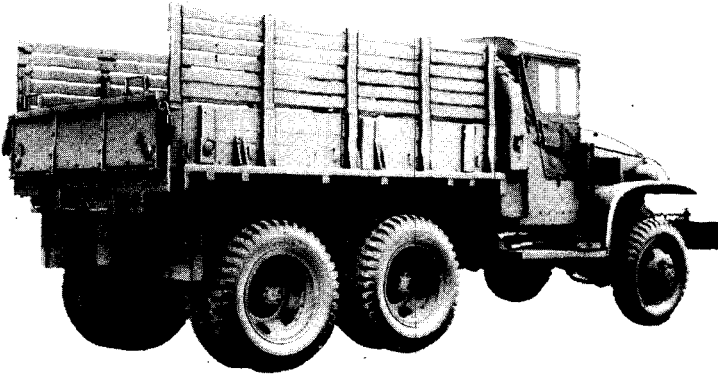

RIGHT REAR VIEW

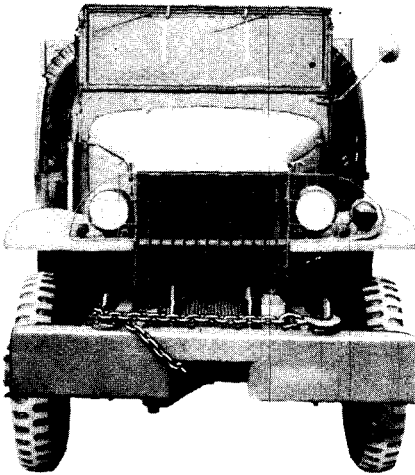

STRAIGHT FRONT VIEW

**Figure 1—CCKW-352 (Short Wheelbase) with Cargo Body
and Winch—Less Tarpaulin**

RA PD 332854

TRUCK, 2½-TON, 6 x 6

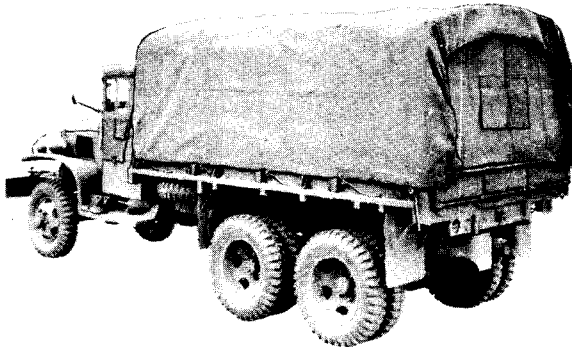

LEFT REAR VIEW

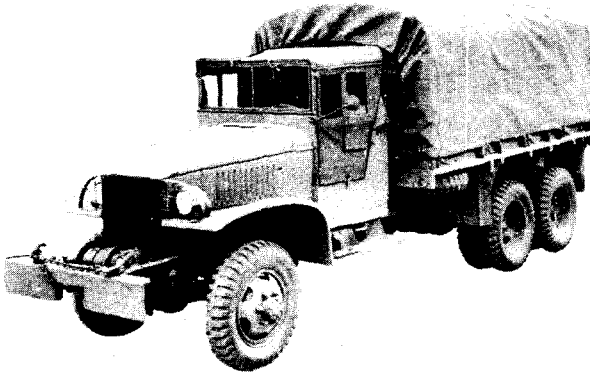

LEFT FRONT VIEW

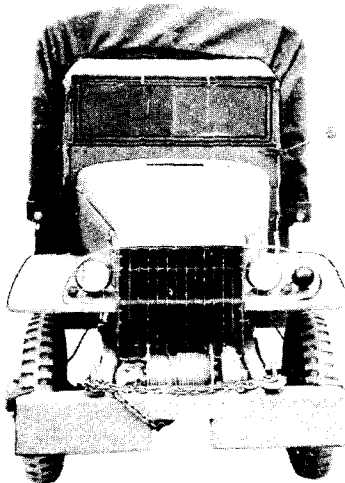

STRAIGHT FRONT VIEW

RA PD 332891

Figure 2—CCKW-353 (Long Wheelbase) with Cargo Body and Winch—Tarpaulin Installed

DESCRIPTION AND TABULATED DATA

is three-point mounted at front end of chassis frame. Conventional accessories such as generator, cranking motor, distributor, oil filter, carbureter, air cleaner, clutch, etc., are attached to engine proper. Transmission, mounted to rear end of engine, has five speeds forward and one reverse, with direct drive in fourth speed and over drive in

fifth. Clutch is single dry-plate type attached directly to flywheel.

(2) **AXLES, SUSPENSION, AND STEERING.** Three driving axles are full-floating and may be either split or banjo type. Front axle incorporates special universal joints at the steering knuckles which permit steering of vehicle in conventional automotive manner. Suspension of axles from chassis frame is with semi-elliptic springs, with torque rod connections used at rear axles. Each front spring is attached to conventional two-channel type frame by a shackle at front end, and a bracket at rear end. Each rear spring is supported at the center on cross shaft bearings. Ends of rear springs are fitted into guides at wheel ends of rear axles.

(3) **BRAKES.** Service brakes are vacuum operated hydraulic type, operating two mechanical brake shoes at each wheel. Hydraulic master cylinder, operated by foot brake pedal, actuates Hydrovac power cylinder, which in turn transmits hydraulic pressure to wheel cylinders to apply brakes. Band type hand brake assembly is mounted on output shaft at rear of transfer case. Conventional latch type hand brake lever operates brake through rods and linkage for emergency stops, or to hold vehicle while parking.

(4) **POWER DRIVE UNITS.** Two-speed transfer case permits drive by rear axles, or front and rear axles, depending upon position of manual shift levers. Axles are driven through conventional type propeller shafts from transfer case. Power take-off for winch and hoist operation (when used) is mounted on left side of transmission, and drives these auxiliary units through universal joint type drive shafts.

(5) **WINCH.** The winch, when supplied, is mounted at front end of vehicle, and is driven through drive shaft by transmission power take-off.

(6) **CAB.** The two-man cab consists of a metal open top enclosure around driver's compartment. Cab is equipped with windshield, tarpaulin and hinged side curtains, and provision for gun mount ring.

(7) **BODY TYPES.**

(a) *Cargo* (figs. 1 and 2). Wood type cargo body, equipped with troop seats, cargo racks, bows, and top tarpaulin, may be mounted on either long wheelbase (CCKW-353) or short wheelbase (CCKW-352) chassis.

(b) *Cargo Dump* (fig. 3). Metal type cargo dump body, equipped

TRUCK, 2½-TON, 6 x 6

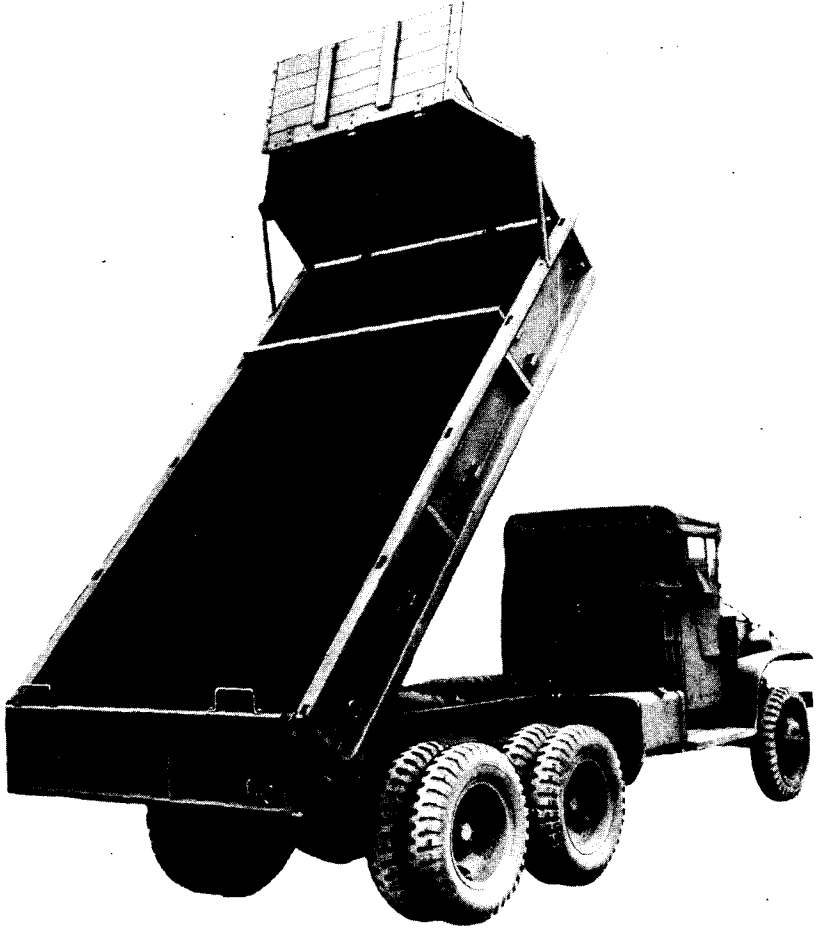

RA PD 64759

**Figure 3—CCKW-353 (Long Wheelbase) with Cargo
Dump Body—Less Tarpaulin**

similar equipment. Chassis upon which gasoline tanks are mounted are not equipped with winches or pintle hooks.

(d) *Water Tank Body* (fig. 5). Metal water tank body of 700 gallon capacity is mounted only on long wheelbase (CCKW-353) chassis. Tank body is equipped with auxiliary gasoline engine and pump unit, control valves, portable heating unit, and heating connections to chassis exhaust pipe system. Chassis upon which water tank bodies are mounted are not equipped with winches or pintle hooks.

(e) *Special Purpose Bodies*. Either long wheelbase or short wheelbase chassis (CCKW-353 or 352) with or without winch, may be used with special purpose bodies such as van, water purification,

DESCRIPTION AND TABULATED DATA

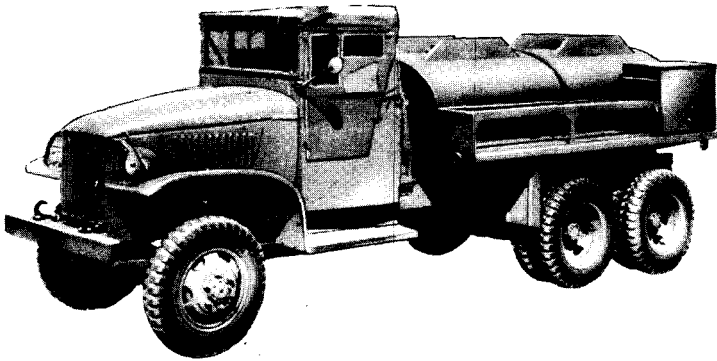

LEFT VIEW

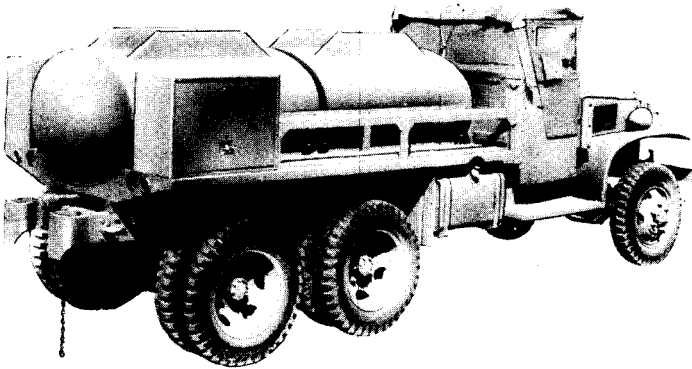

RIGHT REAR VIEW

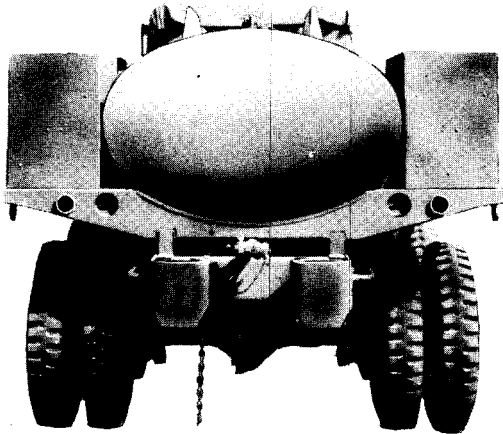

STRAIGHT REAR VIEW

**Figure 4—CCKW-353 (Long Wheelbase) with Gasoline Tank
Body—Less Camouflage Equipment**

RA PD 332888

TRUCK, 2½-TON, 6 x 6

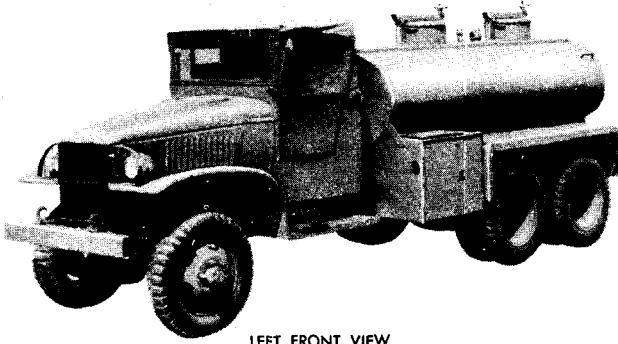

LEFT FRONT VIEW

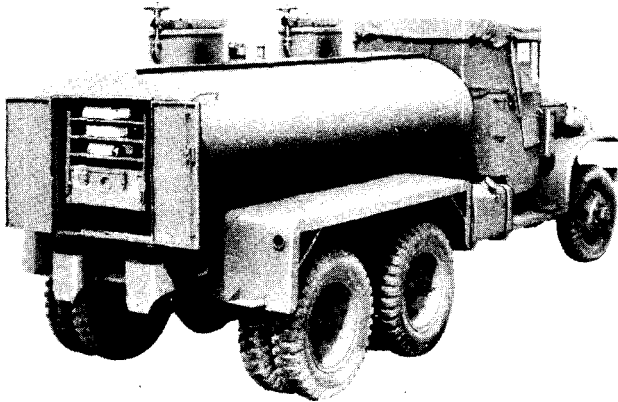

RIGHT REAR VIEW

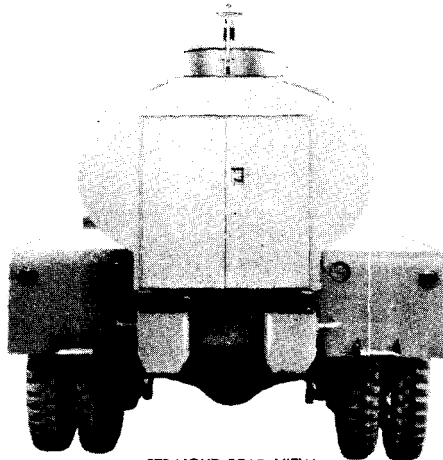

STRAIGHT REAR VIEW

**Figure 5—CCKW-353 (Long Wheelbase) with Water Tank
Body—Less Camouflage Equipment**

RA PD 332868

DESCRIPTION AND TABULATED DATA

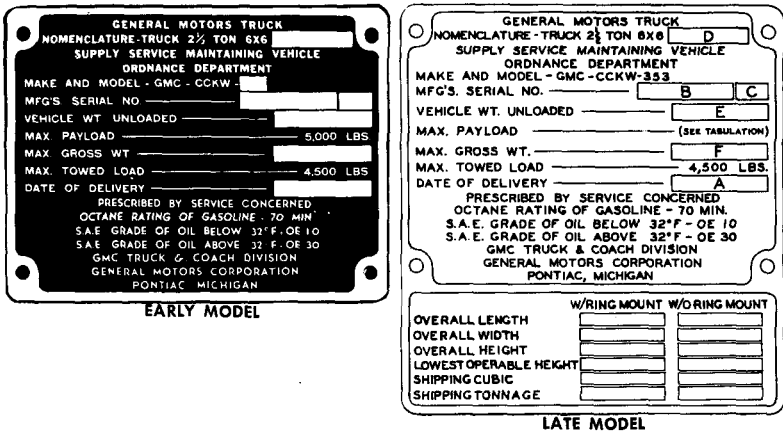

Figure 6—Vehicle Nomenclature Plates

RA PD 332860

oil service, shop, topophoto, and air compressor. These bodies are not described in this manual.

4. DIFFERENCES AMONG MODELS.

a. **Model Designation.** Model designation symbols, together with suffix letters and numbers, are stamped on nomenclature plate (fig. 6). These identification letters and numbers are all that are necessary to identify the vehicle as to wheelbase, type of axle, body type, and whether or not it is equipped with a winch. The numerals appearing after the model designation and the equipment suffix represent the chassis serial number. The nomenclature plate used on late vehicles contains information pertinent to shipping (fig. 6). The following table itemizes and explains the vehicle identification symbols.

VEHICLE IDENTIFICATION

| Symbols | Explanation of Symbols | | | | |
|--------------------|------------------------|-------------------|-----------|-----------|-----------------|
| | Equipment Suffix | Chassis Wheelbase | Axle Type | Body Type | Winch |
| GMC Model CCKW-352 | A1 | 145-inch | split | cargo | none |
| CCKW-352 | B1 | 145-inch | split | cargo | yes |
| CCKW-352 | A2 | 145-inch | banjo | cargo | none |
| CCKW-352 | B2 | 145-inch | banjo | cargo | yes |
| CCKW-353 | 1 | 164-inch | split | none | with or without |
| CCKW-353 | 2 | 164-inch | banjo | none | with or without |
| CCKW-353 | A1 | 164-inch | split | cargo | none |

TRUCK, 2½-TON, 6 x 6

VEHICLE IDENTIFICATION (Cont.)

| Symbols | Explanation of Symbols | | | | |
|----------|------------------------|------------------|-------------------|------------|-----------|
| | GMC Model | Equipment Suffix | Chassis Wheelbase | Axle Type | Body Type |
| CCKW-353 | A2 | 164-inch | banjo | cargo | none |
| CCKW-353 | B1 | 164-inch | split | cargo | yes |
| CCKW-353 | B2 | 164-inch | banjo | cargo | yes |
| CCKW-353 | D1 | 164-inch | split | gas tank | none |
| CCKW-353 | D2 | 164-inch | banjo | gas tank | none |
| CCKW-353 | A1 | 164-inch | split | water tank | none |
| CCKW-353 | G2 | 164-inch | banjo | water tank | none |
| CCKW-353 | H1 | 164-inch | split | dump | yes |
| CCKW-353 | H2 | 164-inch | banjo | dump | yes |

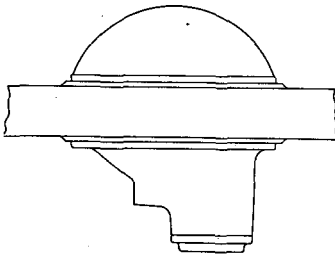

BANJO TYPE AXLE

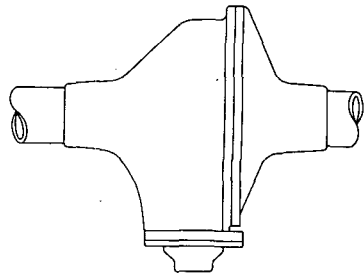

SPLIT TYPE AXLE

Figure 7—Axle Housing Identification

RA PD 64499

b. **Axle Housing Types.** Vehicles may be equipped with either split type (indicated by suffix numeral 1) or banjo type (indicated by suffix numeral 2). These axle housing types can be identified as illustrated in figure 7.

c. **Spare Tire and Vehicle Gas Tank Location.**

(1) **SHORT WHEELBASE (CCKW-352).** Spare tire and wheel carrier, and gasoline tank on short wheelbase chassis (CCKW-352) are mounted across chassis frame at rear of cab.

(2) **LONG WHEELBASE (CCKW-353).** On long wheelbase chassis with cargo or cargo dump body only, spare wheel and tire are mounted under body on frame left side rail. The gasoline tank is mounted on frame right side rail immediately forward of forward rear wheel. On long wheelbase chassis with gas or water tank body, the spare wheel and tire are mounted on frame back of cab, while vehicle fuel tank location remains the same as on conventional long wheelbase chassis.

DESCRIPTION AND TABULATED DATA



ENGINE SERIAL NUMBER—ON RIGHT SIDE OF BLOCK

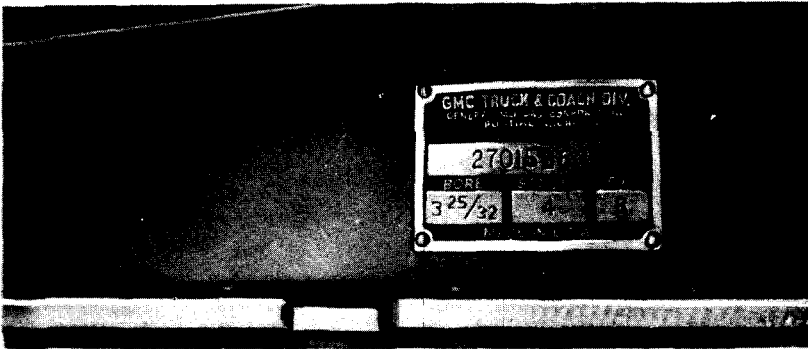

ENGINE SERIAL NUMBER—ON LEFT SIDE OF BLOCK

| PUBLICATIONS APPLYING TO THIS VEHICLE | |
|---------------------------------------|-----------|
| OPERATORS MANUAL | TM 9-801 |
| MAINTENANCE MANUAL | TM 9-1801 |
| PARTS LIST | SNL-G-508 |

PUBLICATIONS PLATE

RA PD 332890

Figure 8—Engine Serial Number and Publication Plates

d. **Engine Serial Number and Plate (fig. 8).** This plate includes engine serial number, cylinder bore, piston stroke, and number of cylinders. Plate is attached to left side of engine crankcase. Engine serial number is also stamped on right side of engine crankcase near distributor.

e. **Publication Plate (fig. 8).** This plate includes TM numbers of technical manuals and parts list to use with vehicle. Plate is located on dash panel above package compartment.

f. **Water Tank and Gasoline Tank Body Camouflage (fig. 9).** Some vehicles, equipped with water tank or gasoline tank bodies, are provided with bows and tarpaulins to serve as camouflage. With tarpaulin installed, vehicles have the appearance of cargo bodies.

TRUCK, 2½-TON, 6 x 6

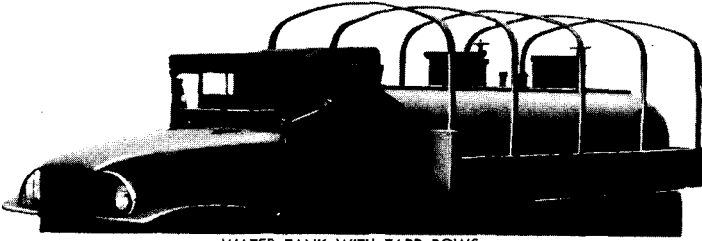

WATER TANK WITH TARP BOWS

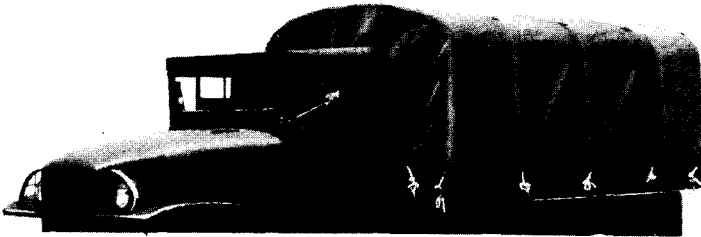

WATER TANK WITH TARP INSTALLED

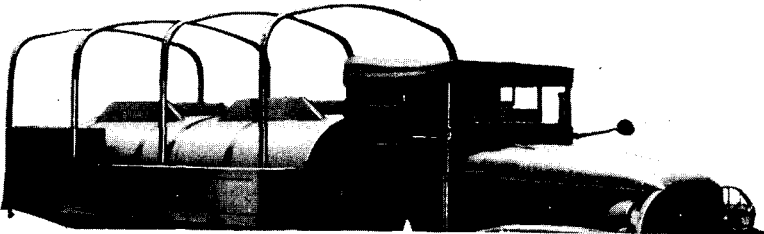

GAS TANK WITH TARP BOWS

RA PD 332944

Figure 9—Tarpaulin Camouflage Equipment for Water or Gasoline Tank Body

5. TABULATED DATA.

a. Engine Specifications (All Vehicles).

| | |
|-----------------------------------|---------------------------------|
| Type | Valve-in-head |
| Number of cylinders | 6 in-line |
| Horsepower (S.A.E.) | 34.35 |
| Displacement (Cu in.) | 269.5 |
| Bore (in.) | 3 ²⁵ / ₃₂ |
| Stroke (in.) | 4 |
| Engine governed speed (rpm) | 2,750 |

DESCRIPTION AND TABULATED DATA

b. Chassis and Body Specifications and Dimensional Data.

(1) VEHICLE WEIGHTS (Approx.).

| Chassis and cab only— <i>with fuel, oil, and water</i> (lb) | CCKW-352 | | MODELS | | CCKW-353 GI or G2 |
|--|-------------|-------------|----------------------|----------------------|----------------------|
| | AI-A2-B1-B2 | AI-A2-B1-B2 | CCKW-353 HI or H2 | CCKW-353 DI or D2 | |
| With winch..... | 9,167 | 8,800 | 8,696 | | |
| Without winch..... | 8,462 | 8,100 | | | |
| <i>Chassis, cab, and body—with fuel, oil, and water</i> (lb) | | | | | |
| With winch..... | 11,050 | 11,050 | 11,950 | | |
| Without winch..... | 10,350 | 10,350 | | 10,750 | 12,025 |
| Maximum permissible payload (lb)..... | 5,000 | 5,000 | 5,000 | 750 (gal) | 700 (gal) |
| Maximum permissible towed load (lb)..... | 4,500 | 4,500 | 4,500 | 4,500 | 4,500 |
| <i>Gross weight</i> (lb) | | | | | |
| With winch..... | 16,400 | 16,400 | 17,300 | | |
| Without winch..... | 15,700 | 15,700 | | 15,750 | 18,200 |

(2) DIMENSIONAL DATA (fig. 10).

Shipping cubic

| | | | | | |
|---------------------------------------|-------|-------|-------|-------|-------|
| With winch—with ring mount..... | 1,246 | 1,375 | 1,378 | | |
| With winch—without ring mount..... | 975 | 1,043 | 1,058 | | |
| Without winch—with ring mount..... | 1,180 | 1,305 | | 1,334 | 1,316 |
| Without winch—without ring mount..... | 897 | 991 | | 1,086 | 1,252 |

Shipping Tonnage

| | | | | | |
|---------------------------------------|------|------|-------|-------|-------|
| With winch—with ring mount..... | 31.4 | 34.5 | 34.8 | | |
| With winch—without ring mount..... | 24.5 | 26.0 | 26.5 | | |
| Without winch—with ring mount..... | 29.5 | 32.5 | | 33.4 | 33.0 |
| Without winch—without ring mount..... | 22.4 | 24.8 | | 27.2 | 31.4 |

TRUCK, 2 1/2-TON, 6 x 6

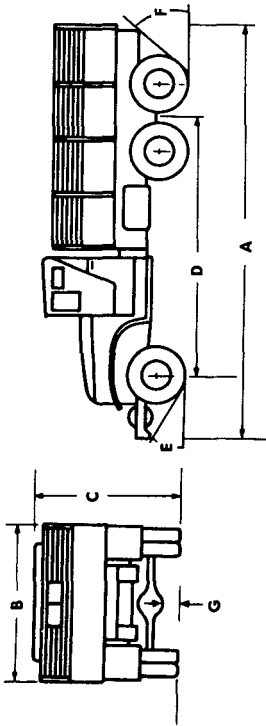

A OVER-ALL LENGTH
 B OVER-ALL WIDTH
 C OVER-ALL HEIGHT
 D WHEELBASE
 E ANGLE OF APPROACH
 F ANGLE OF DEPARTURE
 G GROUND CLEARANCE TO AXLE

NOTE—REFER TO TABULATED DATA

RA PD 332849

Figure 10—Vehicle Dimensional Drawing (CCKW-353 With Cargo Body and Winch Shown)

| | CCKW-352 | | CCKW-353 | | MODELS | |
|---|-------------|-------------|-------------|-------------|----------|----------|
| | AI-A2-B1-B2 | AI-A2-B1-B2 | AI-A2-B1-B2 | AI-A2-B1-B2 | HI or H2 | GI or G2 |
| Maximum overall length (in.) | | | | | | |
| With winch | 244 7/8 | 270 1/8 | 270 1/8 | 270 1/8 | 272 3/4 | 253 1/2 |
| Without winch | 231 | 256 1/4 | 256 1/4 | 256 1/4 | 253 1/2 | 253 1/2 |
| Maximum overall width (in.) | 88 | 88 | 88 | 88 | 88 | 90 |
| Maximum overall height (in.) | | | | | | |
| Cab—loaded | 91 | 91 | 91 | 91 | 91 | 91 |
| Cab—unloaded | 93 | 93 | 93 | 93 | 93 | 93 |
| Tarpaulin installed—loaded (without ring mount) | 107 1/8 | 107 1/8 | 107 1/8 | 107 1/8 | 106 1/8 | 106 1/8 |
| Tarpaulin installed—unloaded (without ring mount) | 109 1/8 | 109 1/8 | 109 1/8 | 109 1/8 | 108 1/8 | 108 1/8 |
| With ring mount—loaded | 117 | 117 | 117 | 117 | 117 | 117 |
| With ring mount—unloaded | 119 | 119 | 119 | 119 | 119 | 119 |
| Protection plate—loaded | 111 3/4 | 111 3/4 | 111 3/4 | 111 3/4 | 111 3/4 | 111 3/4 |
| Protection plate—unloaded | 113 3/4 | 113 3/4 | 113 3/4 | 113 3/4 | 113 3/4 | 113 3/4 |

DESCRIPTION AND TABULATED DATA

| | | |
|--|-----------|-----------|
| Tank—loaded..... | 79½ | 93 |
| Tank—unloaded..... | 81½ | 95 |
| Lowest operable height (in.) | | |
| With ring mount—loaded..... | 98 | 98 |
| With ring mount—unloaded..... | 100 | 100 |
| Without ring mount—loaded..... | 74 | 79½ |
| Without ring mount—unloaded..... | 76 | 81½ |
| Nominal wheelbase (in.)..... | 164 | 164 |
| Tread (in.) | | |
| Front—banjo..... | 60 | 60 |
| Front—split..... | 62¼ | 62¼ |
| Rear—banjo..... | 67½ | 67½ |
| Rear—split..... | 67¾ | 67¾ |
| Tire size..... | 7.50 x 20 | 7.50 x 20 |
| (3) OPERATIONAL DATA (fig. 10). | | |
| Angle of approach (deg) | | |
| With winch..... | 31 | 31 |
| Without winch..... | 54 | 54 |
| Angle of departure (deg)..... | 44 | 36 |
| Ground clearance at axles (in.)..... | 9⅞ | 9⅞ |
| Minimum outside wheel track turning circle diameter— front axle disengaged—left or right turn (ft)..... | 68 | 70 |
| Maximum gradeability (percent) | | |
| Direct..... | 3½* | 3½ |
| Low..... | 65* | 65 |
| Maximum allowable speed (mph)..... | 45 | 45 |
| *With 19,500 lb G.T.W. | | |

TRUCK, 2½-TON, 6 x 6

Section III

TOOLS, PARTS, AND ACCESSORIES

6. PURPOSE

a. The lists in this section are for information only and must not be used as a basis for requisition.

7. ON VEHICLE TOOLS.

a. Pioneer Tools (fig. 11).

| Quantity Per Vehicle | Stockage Number | Name | Stowage Location |
|----------------------|-----------------|--------------------------------------|---------------------|
| 1 | 41-A-1277 | Axe, chopping, single bit, 5 lb..... | R. H. running board |
| 1 | 41-M-720* | Mattock, pick M1, with handle..... | R. H. running board |
| 1 | 41-S-3170 | Shovel, D handle, round point..... | L. H. running board |

b. Vehicle Tools (fig. 12).

(1) Following tools are supplied with all vehicles:

| | | | |
|---|--------------|--|------------------|
| 1 | 41-H-523 | Hammer, machinists, 16-oz..... | Tool compartment |
| 1 | GM-2146130 | Handle, wrench (used with wheel nut wrench).... | Tool compartment |
| 1 | 41-J-72 | Jack, hydraulic, 3-ton, with handle..... | Tool compartment |
| 1 | 41-P-1650 | Pliers, combination—6-in..... | Tool compartment |
| 1 | 41-S-1076 | Screw driver, common, heavy duty, 6-in..... | Tool compartment |
| 1 | 41-S-1636 | Screw driver, No. 1, cross recess—3-in..... | Tool compartment |
| 1 | 41-S-1638 | Screw driver, No. 2, cross recess—4-in..... | Tool compartment |
| 1 | 41-S-1640 | Screw driver, No. 3, cross recess—6-in..... | Tool compartment |
| 1 | 41-S-1642 | Screw driver, No. 4, cross recess—8-in..... | Tool compartment |
| 1 | 41-W-991 | Wrench, engineers, open end, ¾-in. and ⅞-in.. | Tool compartment |
| 1 | 41-W-1003 | Wrench, engineers, open end, ½-in. and 19/32-in.. | Tool compartment |
| 1 | 41-W-1005-5 | Wrench, engineers, open end, 9/16-in. and 11/16-in.. | Tool compartment |
| 1 | 41-W-1008-10 | Wrench, engineers, open end, 5/8-in. and 25/32-in.. | Tool compartment |

TOOLS, PARTS, AND ACCESSORIES



PIONEER TOOLS—RIGHT-HAND RUNNING BOARD

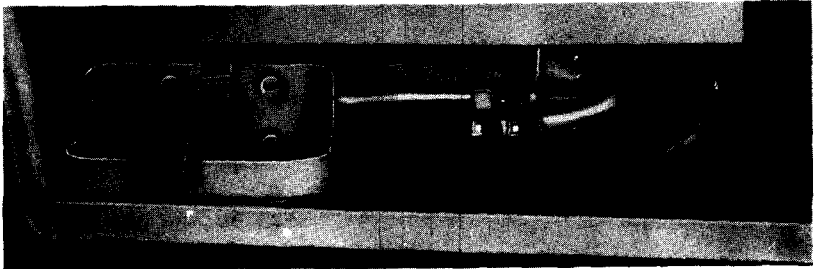

PIONEER TOOLS—LEFT-HAND RUNNING BOARD

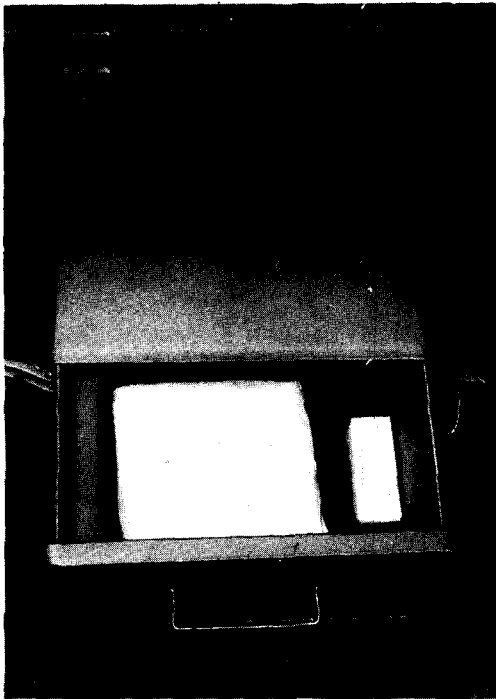

SPARE PARTS KIT CONTAINER

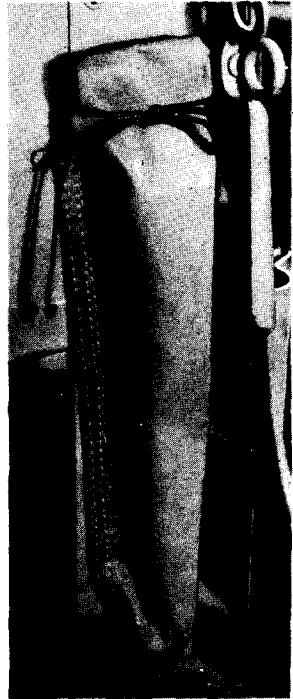

GASOLINE CAN SPOUT

RA PD 332993

Figure 11—Pioneer Tools, Spare Parts Kit, and Oil Can Spout

TRUCK, 2 1/2-TON, 6 x 6

| Quantity Per Vehicle | Stockage Number | Name | Stowage Location |
|----------------------|---|--|------------------|
| 1 | 41-W-1012-5 | Wrench, engineers, open end, 3/4-in. and 7/8-in. | Tool compartment |
| 1 | 41-W-450 | Wrench, adj. auto type— | |
| 1 | 41-W-3335-50 | 15-in. | Tool compartment |
| 1 | 41-W-3838-30 | Wrench, spark plug, with handle | Tool compartment |
| 1 | 41-W-3838-30 | Wrench, wheel nut | Tool compartment |
| (2) | The following tool is included in vehicles equipped with banjo type axles: | | |
| 1 | 41-W-1493-30 | Wrench, wheel bearing nut | Tool compartment |
| (3) | The following tools are included in vehicles equipped with split type axles: | | |
| 1 | 41-W-1991-10 | Wrench, front wheel bearing nut | Tool compartment |
| 1 | 41-W-3825-100 | Wrench, rear wheel bearing nut | Tool compartment |
| (4) | The following additional tools are supplied with vehicles equipped with water tank bodies: | | |
| 1 | 41-P-1650 | Pliers, combination— | |
| | | 6-in. | Equipment chest |
| 1 | | Screw driver—3-in. | Equipment chest |
| 1 | | Wrench, adj. hydrant | Equipment chest |
| 1 | | Wrench, box end—1/2 x 9/16-in. | Equipment chest |
| 2 | | Wrench, adj. pipe— | |
| | | 18-in. | Equipment chest |
| 1 | | Wrench, adj. (monkey)— | |
| | | 8-in. | Equipment chest |
| 2 | | Wrench, spanner— | |
| | | 1 1/2-in. | Equipment chest |
| (5) | The following additional tool is supplied with vehicles equipped with gasoline tank bodies: | | |
| 1 | GM-2165960 | Wrench, discharge faucet | Cabinet |

8. ON VEHICLE EQUIPMENT.

a. The following equipment is supplied with all vehicles:

| | | | |
|---|----------|--|---------------------------------|
| 1 | | Catalog, Ord. std. nomenclature list G-508 | Instrument panel compartment |
| 1 | | Book, technical manual, TM 9-801 | Instrument panel compartment |
| 1 | 41-B-15 | Bag, tool | Tool compartment |
| 2 | | Container, liquid | Running boards |
| 4 | 8-C-1575 | Chain, dual tire | Under driver's seat |
| 2 | 8-C-2380 | Chain, single tire | Under driver's seat |
| 1 | 58-E-202 | Extinguisher, fire—1 qt. | In bracket in right side of cab |

TOOLS, PARTS, AND ACCESSORIES

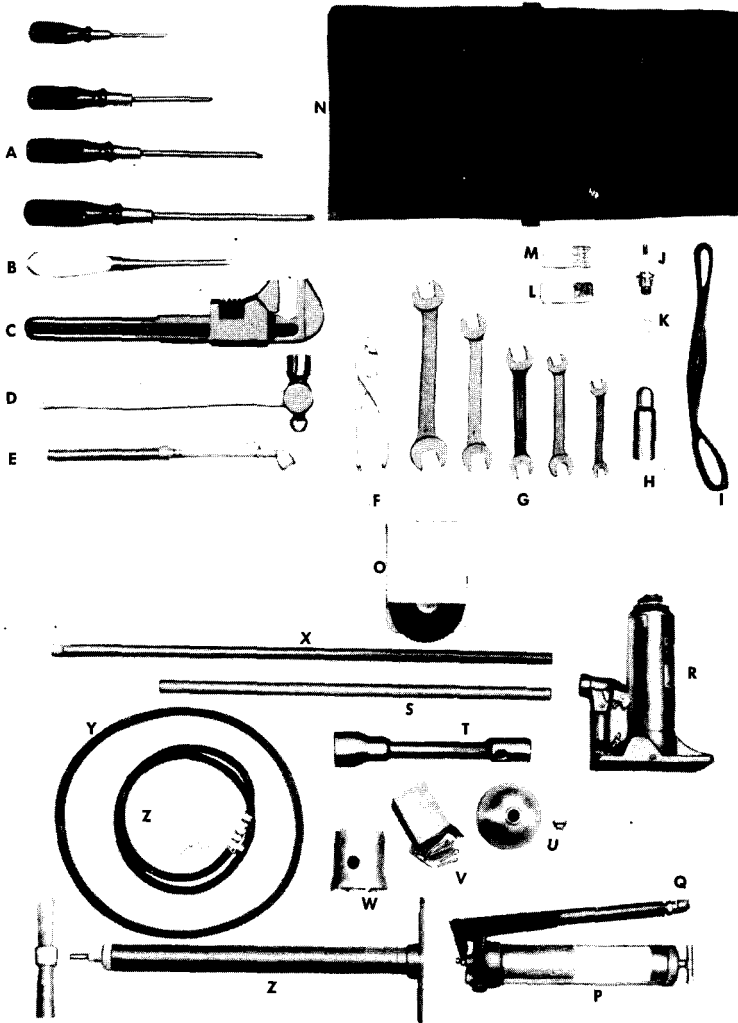

- A CROSS RECESS TYPE SCREWDRIVERS
- B STANDARD SCREWDRIVER
- C ADJUSTABLE WRENCH
- D BALL PEEN HAMMER
- E TIRE PRESSURE GAGE
- F PLIERS
- G END WRENCHES
- H SPARK PLUG WRENCH
- I IRON WIRE
- J SPARK PLUG
- K SPARK PLUG GASKET
- L TIRE VALVE CAPS
- M TIRE VALVE CORES
- N TOOL BAG

- O FRICTION TAPE
- P LUBRICATION GUN
- Q LUBRICATION GUN NOZZLE
- R JACK
- S JACK HANDLE
- T WHEEL NUT WRENCH
- U OILER AND SPOUT
- V COTTER PINS
- W WHEEL BEARING NUT WRENCH
- X HANDLE FOR BEARING AND WHEEL NUT WRENCH
- Y DRIVE BELT
- Z TIRE PUMP AND HOSE

Figure 12—Tools and Spare Parts

RA PD 332972

TRUCK, 2 1/2-TON, 6 x 6

| Quantity Per Vehicle | Stockage Number | Name | Stowage Location |
|----------------------|-----------------|--|--------------------------------|
| 1 | 41-G-615 | Gage, tire pressure | Tool compartment |
| 1 | 41-G-1344-40 | Gun, lubricating, hand type | Tool compartment |
| 1 | 13-O-1530 | Oiler, straight spout, spring bottom | Front of dash |
| 1 | | Order, Lubrication, War Department No. 504 | In holder on cab |
| 1 | 8-P-5000 | Pump, tire | Tool compartment |
| 1 | | Spout, gasoline can | Right side of instrument panel |

b. The following additional equipment is included in vehicles not equipped with winch.

| | | | |
|---|------------|-----------------------------------|------------------|
| 1 | GM-2146902 | Bracket, starting crank | Tool compartment |
| 1 | GM-2147197 | Crank, starting | Tool compartment |

c. The following additional equipment is supplied with vehicles equipped with winch.

| | | | |
|---|------------|------------------------------------|---------------------|
| 1 | GM-111301 | Adapter, lubrication gun | Tool compartment |
| 1 | 19-B-30990 | Block, snatch | Under driver's seat |
| 1 | GM-2146903 | Bracket, starting crank | Tool compartment |
| 1 | GM-2147196 | Crank, starting | Tool compartment |

d. The following additional equipment (fig. 13) is supplied with vehicles equipped with gasoline tank bodies:

| | | | |
|---|------------|--|--------------------|
| 2 | GM-2144329 | Can, gasoline—5 gal. | On body run boards |
| 1 | GM-2165986 | Coupling, hose—2 x 1 1/2 in. dia | Cabinet |
| 1 | GM-2165987 | Coupling, hose—2 x 1 1/2 in. dia | Cabinet |
| 1 | GM-2165985 | Coupling, twin—2 x 1-in. dia | Cabinet |
| 1 | GM-2144530 | Funnel | Cabinet |
| 1 | GM-2165980 | Gage, measuring | Cabinet |
| 1 | GM-2182360 | Hose, gasoline—10 ft long | Cabinet |
| 2 | GM-2154988 | Hose, gasoline—8 ft long | Cabinet |
| 2 | GM-2165984 | Nozzle, valve | Cabinet |

e. The following additional equipment (fig. 13) is supplied with vehicles equipped with water tank bodies:

| | | | |
|---|----------|--|-----------------------|
| 1 | WV-U-196 | Crank, starting | Pump cabinet |
| 1 | | Gage, measuring | Equipment compartment |
| 3 | | Hose, discharge—25 ft. long | Equipment compartment |
| 6 | | Hose, suction—10 ft. long | Equipment compartment |
| 1 | | Nipple, pipe—1 1/2 x 6 in. | Equipment chest |
| 1 | | Nipple, pipe—1 1/2 x 1 3/4 in. | Equipment chest |

TOOLS, PARTS, AND ACCESSORIES

| Quantity Per Vehicle | Stockage Number | Name | Stowage Location |
|----------------------|-----------------|---------------------------------------|------------------------|
| 3 | | Pipe, immersion heater stove..... | On body running boards |
| 1 | | Reducer, fire hydrant 2½ x 1½ in..... | Equipment chest |
| 1 | | Strainer, suction hose..... | Equipment chest |
| 3 | | Strap, stove pipe..... | On body running boards |
| 1 | | Nozzle, valve..... | Equipment chest |

9. ON VEHICLE SPARE PARTS.

a. Following parts are supplied with all vehicles (fig. 12).

| | | | |
|---|-------------|---|------------------------|
| 1 | 8-C-5498-50 | Container, metal, spare parts containing..... | Under co-driver's seat |
| 1 | GM-2190551 | Belt, drive..... | Spare parts container |
| 1 | 8-C-650 | Kit, tire valve cap..... | Spare parts container |
| 1 | 8-C-6750 | Kit, tire valve core..... | Spare parts container |
| 1 | 17-L-5215 | Lamp, electric, incandescent..... | Spare parts container |
| 1 | 8-L-421 | Lamp unit, blackout stop..... | Spare parts container |
| 1 | 8-L-415 | Lamp unit, blackout tail..... | Spare parts container |
| 1 | 8-L-419 | Lamp unit, service tail and stop..... | Spare parts container |
| 1 | 42-P-5347 | Pin, assorted cotter..... | Spare parts container |
| 1 | GM-1558516 | Plug, spark, with gasket..... | Spare parts container |
| 1 | 17-T-805 | Tape, friction..... | Spare parts container |
| 1 | 41-W-1067 | Wire, iron..... | Spare parts container |

b. Following *additional* parts are supplied with vehicles equipped with winch:

| | | | |
|---|------------|---------------------|-----------------------|
| 1 | GM-2186735 | Kit, shear pin..... | Spare parts container |
|---|------------|---------------------|-----------------------|

c. Following *additional* parts are supplied with vehicles equipped with gasoline tank bodies:

| | | | |
|---|------------|------------------|-----------------------|
| 2 | GM-2182361 | Clamp, hose..... | Spare parts container |
|---|------------|------------------|-----------------------|

TRUCK, 2½-TON, 6 x 6



WATER TANK BODY EQUIPMENT COMPARTMENT

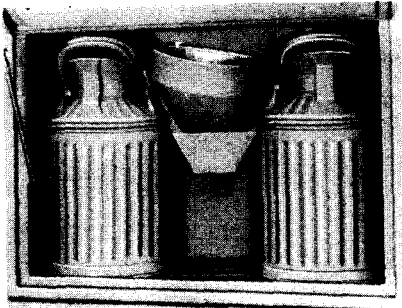

GASOLINE TANK BODY LEFT SIDE CABINET

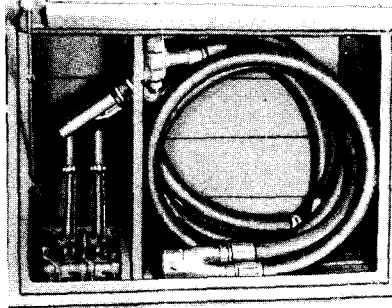

GASOLINE TANK BODY RIGHT SIDE CABINET

RA PD 333003

Figure 13—Tank Body Compartments

| Quantity Per Vehicle | Stockage Number | Name | Stowage Location |
|--|-----------------|------------------------------|------------------|
| d. Following <i>additional</i> parts are supplied with vehicles equipped with water tank bodies: | | | |
| 1 | TL-OW-363 | Bowl, strainer | Equipment chest |
| 1 | | Gasket, set (3 pc) | Equipment chest |

TOOLS, PARTS, AND ACCESSORIES

| Quantity Per Vehicle | Stockage Number | Name | Stowage Location |
|----------------------|-----------------|--------------------------------|------------------|
| 1 | | Gasket, set (10 pc)..... | Equipment chest |
| 1 | | Piston and connecting rod..... | Equipment chest |
| 6 | WV-YD-24 | Plug, spark..... | Equipment chest |
| 2 | WV-AE-73-C | Valve, exhaust..... | Equipment chest |

10. SPECIAL TOOLS.

a. This special tool list is for information only, and must not be used as a basis for requisition.

| Federal Stock No. | Vendor No. | Name of Tool |
|-------------------|----------------------------|---|
| 41-A-18-251 | TEC-50-35 | Adapter, steering wheel puller (use with 41-P-2954) |
| 41-A-335 | KM-K-411 | Arbor, clutch alining |
| 41-H-1074 | KM-J-1660-1 | Handle, driver |
| 41-H-1511 | KM-J-872-5 | Handle, driver (use with 41-R-2396-20) |
| 41-H-1780 | KM-J-1660-3 | Head, driver, remover and replacer, bearing cup (front wheel inner and outer) |
| 41-P-2906-15 | KM-J-164 | Puller, clutch pilot bearing |
| 41-P-2898 | KM-J-918-G | Puller, front and rear wheel inner bearing and oil seal (banjo) |
| 41-R-2397-425 | SH&G-I-440112 | Replacer, rear spring seat seal, inner |
| 41-R-2391-30 | KM-J-1733 | Replacer, rear spring seat inner bearing |
| 41-R-2391-83 | KM-J-1712 | Replacer, front and rear wheel inner bearing (split) |
| 41-R-2396-12 | KM-J-1709 | Replacer, rear wheel bearing inner and outer cup (split) |
| 41-R-2385-275 | KM-J-4221 | Replacer, rear spring seat inner bearing cup |
| 41-R-2385-276 | KM-J-4222 | Replacer, rear spring seat outer bearing cup |
| 41-R-2396-22 | KM-J-872-4 | Replacer, rear wheel inner bearing cup (banjo) |
| 41-R-2396-20 | KM-J-872-1 | Replacer, rear wheel outer bearing cup (banjo) |
| 41-S-503 | KM-J-544-A | Scale, steering gear checking |
| 41-S-3832-7 | {TEC-20789 YT-20-E-190} | Sling, engine lifting |
| 41-W-2964-700 | KM-J-187-1A | Wrench, socket (special cylinder head bolt) (close sweep) 3/4-in. hex. 1/2-in. sq drive |

TRUCK, 2½-TON, 6 x 6

PART TWO

OPERATING INSTRUCTIONS

Section IV

CONTROLS AND INSTRUMENTS

11. GENERAL.

a. The gages, switches, pedal and lever controls, and miscellaneous operating controls are grouped in the driver's compartment or cab (fig. 14).

b. General Data.

| | |
|---|---------------------------|
| Vehicle weights and dimensions | Refer to paragraph 5 |
| Fuel tank capacity | 40 gal |
| Cooling system capacity | 19 qt |
| Crankcase capacity (refill) | Refer to section VIII |
| Tire pressure | Refer to paragraph 198 |
| Type of service brakes | Hydraulic-vacuum |
| Electric system | 6 volt |
| Spark plug size | 14 MM |
| Transmission | Five forward—one reverse |
| Direct drive in | Fourth |
| Overdrive in | Fifth |
| Shifting arrangements | See figure 18 |
| Maximum driving speeds in various gears | See figure 19 |
| Governed speed | 2,750 engine rpm (45 mph) |

12. GAGES AND SWITCHES.

a. **Instrument and Dash Panel** (fig. 15). All gages, speedometer, and panel lights are mounted in instrument panel on dash panel. Light and ignition switches, and throttle and choke control buttons, are mounted on dash board adjacent to instrument panel.

b. **Ignition Switch** (fig. 15). Switch is lever type. Handle must be turned to "ON" position before engine can be started.

c. **Temperature Gage** (fig. 15). Gage, operated through a capillary tube connected to engine thermal unit, indicates temperature of water in cooling system—not *quantity* of water in system. Face of gage unit is graduated from 100°F to 220°F. Operating temperatures between 160°F and 220°F (205°F at high altitudes) are satisfactory for efficient engine operation. Temperatures above 220°F (205°F at high altitudes) or below 160°F (after several miles of operation), indicate improper cooling system operation (par. 56).

d. **Fuel Gage** (fig. 15). Gage, electrically operated and interconnected with tank unit, indicates level of gasoline in fuel tank and registers only after ignition switch is turned on.

e. **Speedometer** (fig. 15). Speedometer, which indicates road

CONTROLS AND INSTRUMENTS

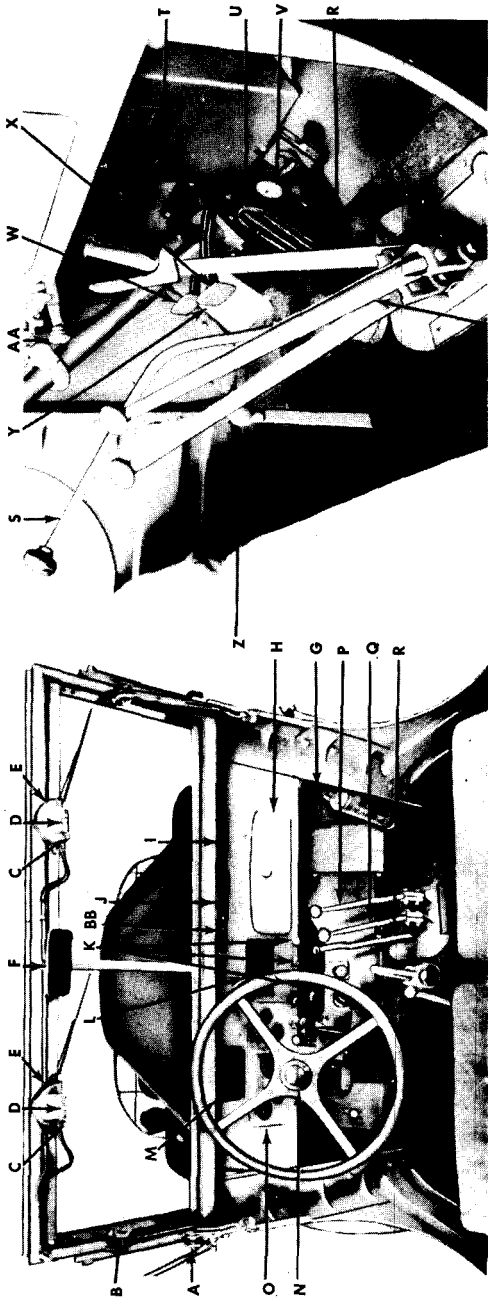

FROM REAR

- A WINDSHIELD ADJUSTING SCREW (LOWER)
- B WINDSHIELD ADJUSTING SCREW (TILT)
- C WIPER CONTROL
- D WIPER MANUAL HANDLE
- E WIPER BODY
- F REAR VIEW MIRROR
- G FIRE EXTINGUISHER
- H MAP COMPARTMENT
- I PUBLICATION PLATE
- J COOLING SYSTEM DRAIN PLATE
- K DASH CONTROLS
- L SHIFTING ARRANGEMENT PLATE
- M MAX. ROAD SPEED PLATE
- N HORN BUTTON

FROM SIDE

- O INSTRUMENT PANEL
- P FRONT AXLE DECLUTCHING LEVER
- Q TRANSFER CASE SHIFT LEVER
- R HAND BRAKE LEVER
- S TRANSMISSION GEAR SHIFT LEVER
- T NOMENCLATURE PLATE
- U ACCELERATOR PEDAL
- V STARTER PEDAL
- W CLUTCH PEDAL
- X BRAKE PEDAL
- Y DIMMER SWITCH
- Z WINCH P.T.O. CONTROL LEVER
- AA COWL VENT OPERATING LEVER
- BB WIRE CAUTION PLATE

RA PD 333011

Figure 14—Driver's Compartment Views

TRUCK, 2 1/2-TON, 6 x 6

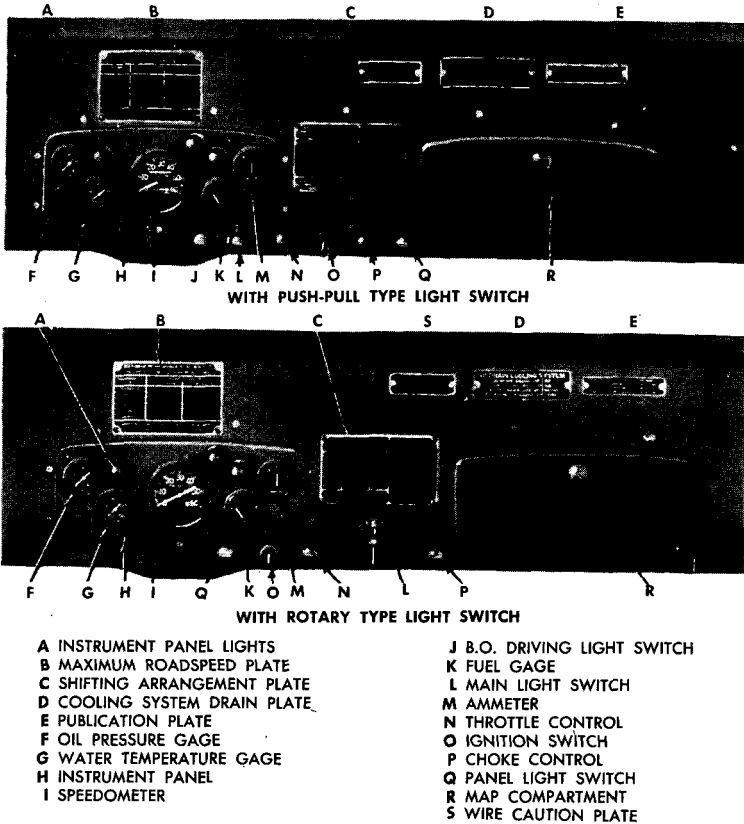

RA PD 332861

Figure 15—Dash Panel and Instrument Cluster

speed of vehicle in miles per hour and records total mileage and *trip* miles, is operated through a flexible shaft by transfer case gears. Trip indicator can be cleared by turning button located on under side of speedometer face.

f. **Oil Pressure Gage** (fig. 15). Oil pressure gage, located on instrument panel, indicates pressure of lubricant in engine crankcase; however, it does not indicate *quantity* of oil in crankcase. When engine first starts, oil consistency may cause a sharp rise in pressure reading. As oil warms up, pressure should recede slowly to normal (5 pounds with engine at slow idle). Pressure readings may fluctuate as engine speed increases or decreases. A sudden drop or an erratic fluctuation of pressure indicates trouble.

g. **Ammeter** (fig. 15). Ammeter indicates charging activity of generating circuit. Ammeter generally shows charge or plus (+) reading when engine is first started. Ammeter will generally show additional charge reading as engine speed is increased, depending upon amount cranking motor has drained the battery.

CONTROLS AND INSTRUMENTS

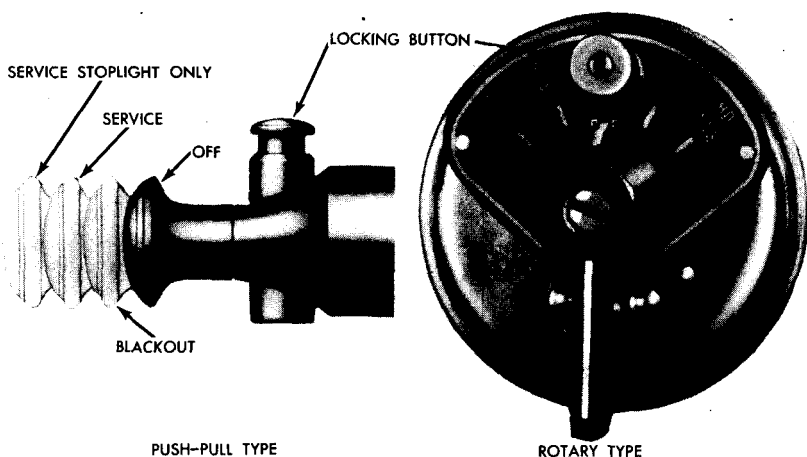

Figure 16—Main Light Switch Operating Positions

RA PD 332864

h. Main Light Switch. Two types of main light switches have been used (fig. 16).

(1) **PUSH-PULL TYPE.** Switch, located on instrument panel, is a four-position push-pull type switch which controls both service and blackout headlights and service and blackout stop and taillights. Switch is equipped with a circuit breaker which automatically opens circuit when a short circuit occurs, and closes circuit when thermostatic element in circuit breaker cools off.

(a) **Off Position.** When switch control button is pushed completely in, all lights, both service and blackout, are turned off. Blackout service stop lights cannot be operated with switch in this position.

(b) **Blackout Position.** When switch button is pulled to first stage, blackout headlights and blackout stop and taillights are energized. Button is locked in place with automatic plunger type lock when pulled to this position.

(c) **Service Position.** Switch locking button at left of switch body must be depressed before switch button can be pulled to second stage or service position. When switch is in service position, service headlights, service stop lights and taillights, and instrument panel lights are energized.

(d) **Service Stop Light Position.** When switch button is pulled completely out, service stop lights may be operated for daylight service.

(2) **ROTARY TYPE.** Switch is a five-position lever type. This switch is also equipped with a circuit breaker.

(a) **Off Position.** When lever is placed in "OFF" position, all lights, both service and blackout, are turned off.

(b) **Blackout Position.** When lever handle is turned to right to "BO MK" position, blackout front marker lights, and blackout stop and taillights are energized.

TRUCK, 2½-TON, 6 x 6

(c) **Blackout Driving Light.** Before lever can be turned to "BO DR" position, left blackout driving light, as well as blackout marker, taillight, and stop light are energized.

(d) **Service Stop Light Position.** Before lever can be placed in "STOP LT" position from "OFF" position, lock plunger must be held in depressed position. When switch is in "STOP LT" position, service stop lights can be operated for daylight conditions.

(e) **Service Position.** Before switch can be placed in "HD LTS" position from "OFF," lock plunger must be depressed. With switch in this position, service headlights, taillights, and stop light are energized. Plunger need not be depressed when turning switch from "STOP LT" to "HD LTS" position.

i. **Blackout Driving Light Switch (fig. 15).** Switch (marked "BO DRIVE"), used only when push-pull main light switch (subpar. h above) is used, is located on instrument panel and energizes blackout driving light which is installed adjacent to left-hand service headlight. The shielded driving light is used in addition to the standard blackout headlights when additional illumination is necessary during blackout conditions. Blackout driving light cannot be operated until main light switch (subpar. h above) is in blackout position.

j. **Blackout Driving Light Switch (with Rotary Type Main Light Switch).** No individual switch is provided for the blackout driving light on vehicles equipped with rotary type main light switch. Refer to subparagraph h (2) (c) above for operation of blackout driving light when rotary type switch is used.

k. **Panel Light Switch (fig. 15).** Switch, located on instrument panel (marked "PANEL"), is a push-pull type and energizes instrument panel lights after main light switch is placed in second or service position.

l. **Dimmer Switch (fig. 14).** This is a foot operated switch, accessible to driver's left foot, and is used to control the upper and lower headlight beams. Switch is not operative unless the main light switch is in service position. Use of this switch permits driver to dim lights when passing other vehicles, or to turn on bright lights when needed.

m. **Stop Light Switch.** Stop light switch, which is connected to hydraulic master cylinder, is not directly actuated by driver. When brake pedal is depressed, hydraulic fluid pressure actuates the switch to light the stop lights when main light switch is in proper position.

n. **Cranking Motor Switch Control (fig. 14).** Cranking motor switch, mounted on body of cranking motor, is actuated by a foot operated pedal located to right of accelerator pedal. Initial movement of pedal engages cranking motor pinion with flywheel ring gear. Further movement completes electrical circuit between battery and cranking motor, causing armature to rotate, thus cranking engine.

CONTROLS AND INSTRUMENTS

13. LEVER CONTROLS.

a. Hand operated lever controls for transmission, transfer case, front axle, and auxiliary equipment (winch and hoist) are located in cab (fig. 14).

(1) **TRANSMISSION.** Transmission gearshift lever, accessible to driver's right hand, is used to select the various gear ratios or speeds provided in transmission. All transmission gear ratios are used in connection with the transfer case. The transmission provides five speeds forward and one reverse. Power is transmitted directly through transmission in fourth speed, providing a 1 to 1 gear ratio. In fifth speed (overdrive) and all other speeds including reverse, the power is transmitted through gears of various sizes to provide the desired gear ratios. Use of transmission gearshift lever is explained in paragraph 16.

(2) **TRANSFER CASE.** Transfer case shift lever is used to shift transfer case into *high* or *low* range to engage driving axles, and into *neutral* to disengage axles. Arrangement of this lever is such that low range cannot be used until front axle lever is placed into "IN" position. Shifting instructions are outlined in paragraph 16.

(3) **FRONT AXLE.** Front axle declutching lever is used to engage and disengage the front driving axle. Lever has only two shifting positions—"IN" and "OUT." Lever must be placed into "IN" position (axle engaged) before transfer case shift lever can be placed into low range position. Shifting instructions are outlined in paragraph 16.

(4) **HAND BRAKE.** Hand brake lever, located to right of driver (fig. 14), is used to control application of a brake band assembly mounted on transfer case. This band operates directly on transfer case output shaft, transmitting braking effort to wheels through propeller shafts. Primary purpose of this brake is to hold vehicle in stationary position or to assist in bringing it to an emergency stop—not to brake vehicle during normal road operation. Lever is pulled back to apply brakes. A pawl in lower end of lever engages notches in sector at base of lever to hold it in various applied positions. Spring loaded release lever at the handle releases pawl from sector notches to permit release of brake.

(5) **AUXILIARY DRIVE.** Power take-off control levers for the engagement of winch and hoist, when used, are located in cab (fig. 14). Instructions for the use of these auxiliary control levers are outlined in paragraphs 24 and 25.

14. PEDAL CONTROLS.

a. **Clutch.** Clutch pedal, accessible to driver's left foot, engages and disengages clutch from flywheel. When pedal is depressed, clutch is disengaged, permitting shifting of transmission gears. When pedal is released, clutch is engaged.

b. **Service Brakes.** Service brake pedal, accessible to driver's right foot, controls application and release of vacuum-hydraulic operated brake shoes at each wheel. Pressure applied to pedal in various degrees applies brakes correspondingly. Release of brakes is correspondingly as rapid as pressure on foot pedal is released.

TRUCK, 2½-TON, 6 x 6

c. **Accelerator Pedal.** This pedal, linked to carbureter, is accessible to driver's right foot. Pedal is used to accelerate or decelerate engine as desired. When pedal is completely released, engine will operate at set idling speed. Acceleration from idling to any desired speed up to governed speed is obtained by depressing the pedal in various degrees.

15. MISCELLANEOUS CONTROLS.

a. **Throttle Control Button** (fig. 15). Throttle control button (marked "THROTTLE") is located on dash panel. Button is interconnected to carbureter and may be used instead of accelerator pedal to accelerate engine. The button is pulled out in varying degrees to accelerate engine and must be pushed back to decelerate. This control is generally used to set throttle to desired starting and warming-up speed, and to obtain sustained speeds when operating auxiliary units.

b. **Choke Control Button** (fig. 15). Choke control button (marked "CHOKE") is located on dash panel. Button is interconnected to carbureter choke valve. When button is pulled out, carbureter choke valve closes. Return spring on choke linkage returns choke valve to open position when button is released. This button is used to operate choke when starting and operating a cold engine.

c. **Windshield Wipers** (fig. 14). Dual windshield wipers, mounted on windshield frame, are vacuum operated. Control button, located on each motor, permits independent operation of each wiper. Control button on each wiper must be pulled out to operate wiper and pushed in to turn wiper off. Each wiper is provided with a manually operated lever to use in the event vacuum line or wiper motor is broken.

d. **Fuel Pump Hand Primer** (fig. 17). Hand primer lever, located at fuel pump, is used to prime carbureter in case vehicle has been standing for long periods, or fuel has been drained from

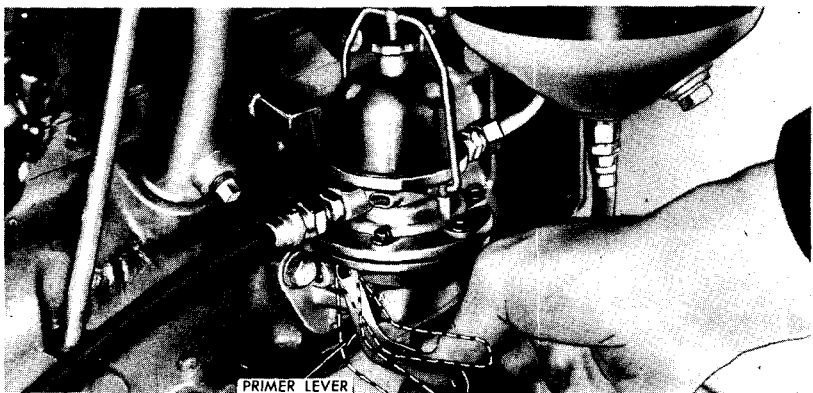

Figure 17—Fuel Pump Hand Primer

RA PD 332893

CONTROLS AND INSTRUMENTS

system, then refilled. As a general rule, several up and down movements of the lever will pump sufficient gas to carburetor for starting.

e. **Cowl Ventilator.** Cowl ventilator lever, located inside cab directly under center of dash panel, is used to open and close cowl ventilator. Push down and forward on lever to open ventilator—pull in handle to close.

f. **Horn Button.** Horn button, located in center of steering wheel, must be depressed to sound electric horn.

Section V

OPERATION UNDER USUAL CONDITIONS

16. TRANSMISSION, TRANSFER CASE, AND FRONT AXLE SHIFTING.

a. **General.** The purpose and use of the transmission and transfer case must be understood by the driver before any attempt is made to drive the vehicle. It must be understood that vehicle cannot be moved until transfer case shift lever is in operating position (high or low range). The transmission gearshift positions do not in any way affect the selection of or shifting into the high and low ranges in the transfer case. The transfer case is the medium by which the power is transferred from the transmission to the driving axles. The ratios provided by the transmission in various speed positions are further increased by gear ratios in the transfer case.

b. **Shifting Arrangements** (fig. 18). Shifting instruction plates showing shifting arrangements for transmission, transfer case, and auxiliary equipment (when used), are located on dash panel.

c. **Maximum Permissible Road Speeds.** Maximum permissible road speeds in various transmission gear positions and transfer case gear ranges are listed on a plate (fig. 19) attached to dash panel. These speeds must not be exceeded.

d. **Driving Axle Combinations.** Vehicles may be driven by rear axles *only*, or by front *and* rear axles. Front axle cannot be driven independently.

(1) **DRIVING REAR AXLES ONLY.** Transfer case must be operated in *high* range only. Front axle declutching lever must be in "OUT" position. Transfer case cannot be operated in low range when *only* rear axles are driving.

(2) **DRIVING FRONT AND REAR AXLES.** Front axle declutching lever must be placed into "IN" position before transfer case shift lever is placed into low range. After front axle has been engaged, transfer case can be operated in either low or high range.

e. **Transfer Case Low and High Ranges.** Various operating

TRUCK, 2 1/2-TON, 6 x 6

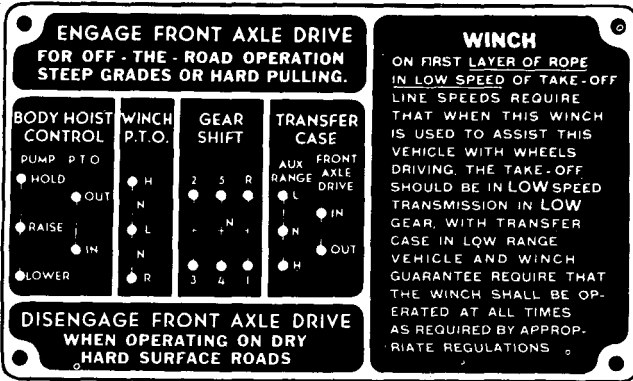

WITH HOIST AND WINCH

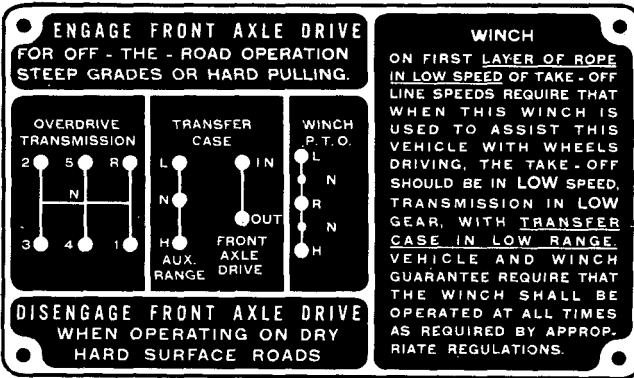

WITH WINCH ONLY

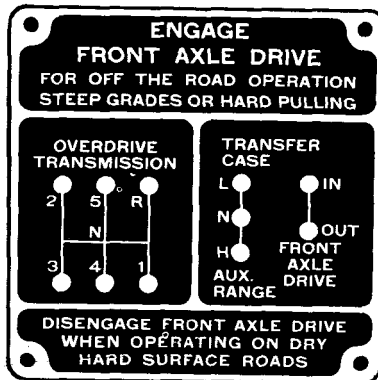

WITHOUT HOIST AND WINCH

Figure 18—Shifting Arrangement Plates

RA PD 333012

OPERATION UNDER USUAL CONDITIONS

| MAXIMUM PERMISSIBLE ROAD SPEEDS IN THE FOLLOWING GEAR POSITIONS | | |
|--|-------------------------|------------------|
| TRANSMISSION IN | TRANSFER CASE IN | |
| | HIGH RANGE | LOW RANGE |
| OVERDRIVE | 45 | 20 |
| DIRECT | 37 | 16 |
| THIRD | 20 | 9 |
| SECOND | 10 | 4 |
| FIRST | 6 | 2 |
| REVERSE | 6 | 2 |

BASED ON 2750 R.P.M. ENGINE MAXIMUM SPEED
6.6-1 AXLE RATIO & 7.50-20 TIRES.

BEFORE DRIVING THRU WIRE
CLOSE FRONT BRAKE VALVE
IN R.H. SIDE RAIL UNDER CAB
INSPECT HOSE AND OPEN VALVE
FOR NORMAL OPERATION

Figure 19—Maximum Permissible Road Speed Plate and Wire Cutting Caution Plate

RA PD 332856

conditions must be considered before choice of transfer case high or low range can be determined. The terrain, grade, and load must be taken into consideration. The driver, after some experience, will automatically select the correct transmission speed and transfer case range.

(1) **HIGH RANGE.** As a general rule, transfer case *high* range is employed when operating on the road where traction is not difficult and the load is light. This range may be used with front and rear axles driving, but generally with only rear axles driving.

(2) **LOW RANGE.** Transfer case cannot be operated in low range until front axle is engaged. With transfer case in low range, the greatest reduction is provided throughout all transmission speeds. Low range is generally used during off-the-road operations where maximum traction and power are required.

f. Transfer Case Shifting (fig. 18).

(1) **HIGH TO LOW RANGE.** This shift should be made while vehicle is on hard ground before difficult terrain is encountered. Speed of vehicle should be reduced below the maximum speed of gear into which shift should be made (fig. 19). Front axle must be engaged (subpar. g below) before transfer case can be operated in low range.

(a) Place front axle declutching lever into "IN" position (subpar. g below).

TRUCK, 2½-TON, 6 x 6

(b) Depress clutch pedal and move transfer case shift lever into neutral ("N") position. Release clutch pedal and accelerate engine (to approximately double that of vehicle speed).

(c) Depress clutch pedal again and move transfer case shift lever forward into low range position. Do not use excessive pressure. Release clutch and accelerate engine to desired speed (refer to maximum permissible road speed plate, fig. 19).

(2) **LOW TO HIGH RANGE.** This shift may be accomplished regardless of vehicle speed.

(a) Depress clutch pedal, then move transfer case shift lever into neutral ("N") position. Release clutch pedal and synchronize engine with vehicle speed.

(b) Depress clutch pedal, then move transfer case shift lever into high range position. Release clutch and accelerate engine. Front axle declutching lever may, if desired, be placed into "OUT" position without using clutch (subpar. g below).

g. Front Axle Declutching Lever Shifting. Front axle should be engaged only in off-the-road operations, slippery roads, on steep grades, or during hard pulling.

(1) **ON-THE-ROAD OPERATION.** The shifting arrangement plate (fig. 18), states "*Disengage front axle drive when operating on dry, hard-surfaced roads.*" This rule generally holds true because in most cases the pulling ability of the two rear axles is sufficient. However, if steep grades are encountered, or if vehicle is called upon to help move an additional load, the front axle should be engaged in order to utilize the pulling ability of all three axles. If heavy loads are to be pulled, the front axle should also be used in getting vehicle under way, after which it may be disengaged, provided the two rear axles can pull the load without stalling the engine.

(2) **OFF-THE-ROAD OPERATION.** The shifting arrangement plate states "**ENGAGE FRONT AXLE DRIVE** for off-the-road operation, steep grades, or hard pulling." The rule holds true whenever the pulling ability of all three axles is required. The driver must use good judgement according to load as well as road conditions.

(3) **ENGAGING FRONT AXLE.** Front axle may be engaged at any vehicle speed without declutching. However, if transfer case is in high range and front axle is to be engaged, and it is desired to operate in low range, shift front axle declutching lever into "IN" position, then place transfer case into low range. Push declutching lever forward quickly and all the way. If difficulty is encountered after exerting a normal pressure on lever, "zig-zag" the front wheels while in motion until engagement is completed.

(4) **DISENGAGING FRONT AXLE.** Front axle may be disengaged at any vehicle speed. If transfer case is in high range, pull declutching lever into "OUT" position without use of clutch; however, if transfer case is in low range, place transfer case shift lever into high range, then place axle declutching lever into "OUT" position. **IMPORTANT:** *If difficulty is encountered in disengaging front axle while exerting a normal pressure on lever, push accelerator to floor rapidly, then release instantly. If difficulty is still encountered, "zig-zag" the*

OPERATION UNDER USUAL CONDITIONS

front wheels, run over bumps in road, or run right front wheel over soft shoulder of road. If axle cannot be disengaged readily after foregoing instructions—stop, reverse a short distance, then repeat above procedure. Do not use excessive force on lever to disengage front axle. Difficulty experienced when shifting front axle is not an indication of faulty shifting mechanism.

h. Transmission Shift from Low to High Speeds. With transfer case shift lever in operating position (low or high), transmission shift from low to higher forward speeds can be accomplished in following manner: Refer to shifting arrangement plate (fig. 18) mounted on dash.

(1) Depress clutch pedal and release accelerator pedal. Place transmission shift lever from neutral into first speed position.

(2) Slowly release pressure on clutch pedal, at the same time slowly depressing accelerator pedal. After engagement is made, accelerate engine until road speed is increased to approximately that indicated on maximum permissible road speed plate (fig. 19).

(3) After necessary road speed has been obtained in first speed, release accelerator pedal, depress clutch pedal, and place transmission into second speed position. Release clutch pedal and accelerate to proper road speed and repeat operations for third, fourth, and fifth speeds—in successive stages.

(4) Fourth speed ratio is direct and is generally used for normal operations on average roads. Fifth speed is over-drive and is generally used to attain maximum no-load speed on good roads.

i. Transmission Shift from High to Low Speeds. Transmission should always be shifted into next lower speed before engine starts to labor or before vehicle speed is appreciably decreased. The need for down-shifting is generally apparent when ascending a steep grade or when more power is needed to pull on rough terrain or in muck or sand. As a precautionary measure, the same ratio used to ascend a grade should be used when descending. When shifting to a lower gear at any rate of vehicle speed, make sure that engine speed is "synchronized" with vehicle speed before clutch is engaged. When engine is operating at lower than relative vehicle speed, the drive line may be damaged.

(1) Depress clutch pedal and release accelerator pedal the same instant. Move transmission shift lever into neutral ("N").

(2) Release clutch pedal and accelerate engine momentarily to synchronize transmission gears. Depress clutch pedal again and move transmission shift lever into next lower speed. Do not force lever, but rather "feel" it into position.

(3) Release clutch pedal and accelerate engine to desired speed. Do not exceed speeds shown on maximum permissible road speed plate (fig. 19). Transmission may be shifted successively into all next lower speeds in same manner.

j. Transmission Shift into Reverse. Vehicle must be brought to a dead stop before transmission gearshift lever can be placed into reverse position. With transfer case in either high or low range, shift transmission into reverse as follows:

TRUCK, 2½-TON, 6 x 6

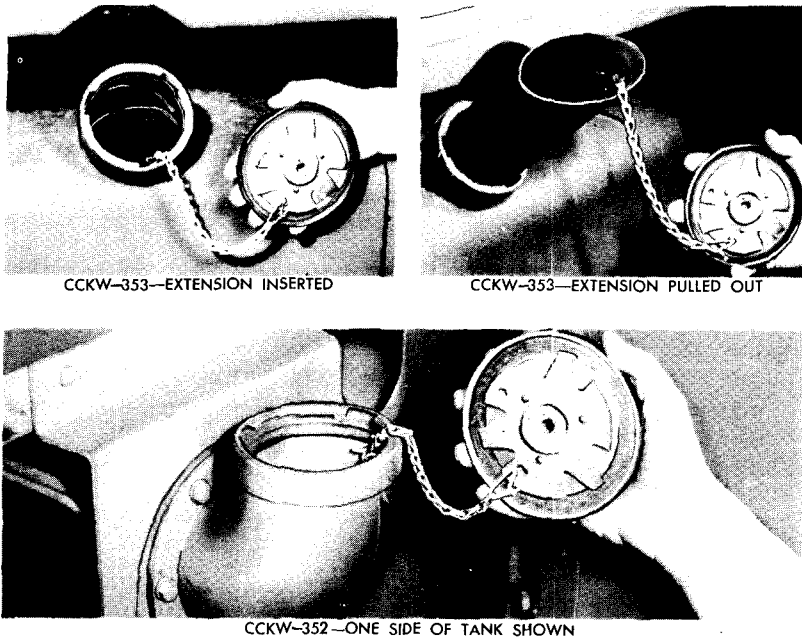

RA PD 332872

Figure 20—Fuel Tank Filler Neck Locations

- (1) Push clutch pedal down to disengage clutch. Press down on foot brake pedal to stop vehicle.
- (2) From neutral position, move shift lever as far as possible to the right, then toward front to reverse (“R”) position.
- (3) Release clutch pedal and accelerate engine to desired speed; however, do not exceed those speeds shown on maximum permissible road speed plate.

17. ENGINE FUEL, OIL, AND WATER.

a. **Fuel Supply** (fig. 20). One fuel tank filler neck, with extension, located directly at tank on side of vehicle, is furnished on long wheelbase chassis (CCKW-353), while the fuel tank on short wheelbase chassis (CCKW-352) is equipped with a filler neck at each side of tank.

(1) **FUEL OCTANE.** Octane rating of gasoline recommended is specified on the vehicle nomenclature plate, and on the decalcomania on engine valve cover. Initial timing of engine is made with this fuel. If fuel of lower or higher octane rating is used, readjustment of ignition timing is necessary (par. 87).

(2) **FILLING TANK.** When filling fuel tank, the supply hose must be properly grounded to prevent static sparks. Pressure type filler cap must be in good condition, and care must be used to prevent entry of dirt, snow, and water into tank.

OPERATION UNDER USUAL CONDITIONS

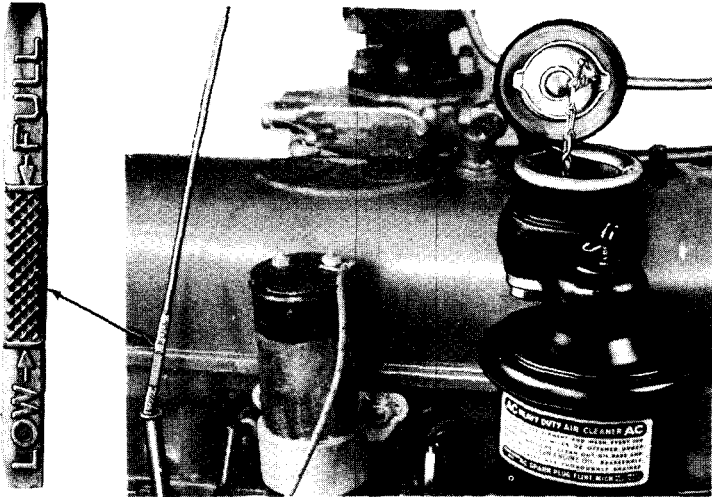

RA PD 332871

Figure 21—Crankcase Oil Filler and Dip Stick

b. **Crankcase Oil** (fig. 21). Crankcase oil filler neck, mounted on right-hand side of engine, is accessible after engine hood is raised. Oil dip stick is also mounted on right-hand side of engine. Lower portion of dip stick is graduated and shows level of oil in crankcase. When checking oil level, dip stick should be withdrawn, lower portion wiped dry, then reinserted and withdrawn again. Crankcase oil level should be kept to "FULL" mark. Remove filler cap [(GM-2162117) G501-01-31557] to replenish oil. Refer to section VIII for lubrication instructions.

c. **Cooling System.** The basis of cooling system coolant is *fresh, clean* water to which must be added a rust preventive compound (par. 107) and antifreeze solution when necessary (par. 31).

(1) **FILLING SYSTEM** (fig. 22). Pressure type radiator filler cap is accessible after engine hood has been raised. This type cap is installed on overflow tank, when used, with a plain notched type cap installed on radiator.

(a) **Removing Radiator Cap.** Loosen cap slowly, particularly when engine is hot. Turn cap in direction of arrow (counterclockwise). Turn cap until it reaches first stage or the safety stop. In this position, cap should be loose so that it can be pressed down against gasket, approximately $\frac{1}{8}$ inch. If escaping air or steam is heard, remove hand from filler cap until it stops. After steam and pressure have been released, press the cap downward, turn to the extreme left, then lift it off.

(b) **Filling Radiator.** Vehicle should be standing on fairly level ground before starting to fill radiator. If system is empty, fill radiator until liquid can be seen through filler neck. If the system is filled with cold liquid, the thermostat will close even though the engine is

TRUCK, 2½-TON, 6 x 6

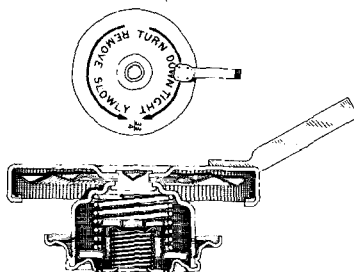
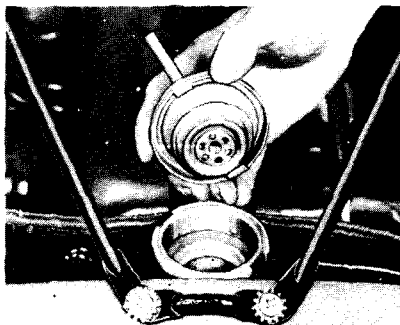

RADIATOR FILLER NECK AND CAP

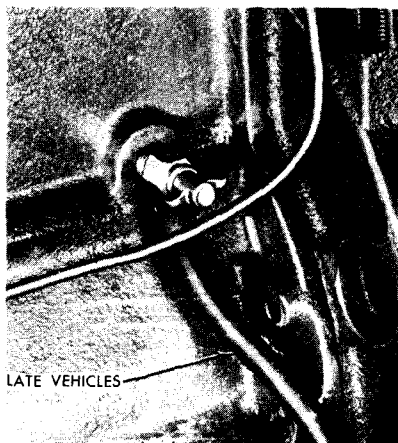

LEFT REAR SIDE OF ENGINE

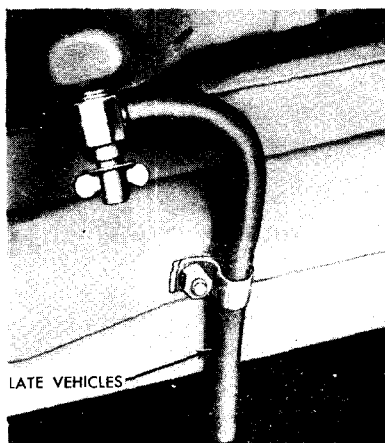

FRONT OF RADIATOR CORE

RA PD 332873

Figure 22—Radiator Filling and Cooling System Drainage Points

warm. This action may trap air in cylinder block and head. The trapped air will leak through thermostat vent hole, thereby lowering liquid level in radiator. Additional coolant should then be slowly added until no further air bubbles are noticed. This method should be used if more than two quarts are necessary to refill radiator. Always fill radiator until liquid is visible through neck. If engine is cold, a loss of approximately one quart will result. If engine is warm, no appreciable loss will be noticed.

(c) *Use of Antifreeze Solution.* Do not overfill radiator when antifreeze solutions are used. Normal expansion of heated water causes level to rise. When engine is stopped and water cools, contraction of liquid lowers level. It is this apparent low level which might indicate the need of additional fluid. Water in system should be hot before any check of level is made.

(2) **DRAINING SYSTEM** (fig 22). One drain cock is provided for bottom of radiator and is accessible from lower side of brush guard.

OPERATION UNDER USUAL CONDITIONS

The second drain cock is located at left rear of engine cylinder block. It is necessary to remove radiator filler cap when draining system.

18. OPERATING THE ENGINE.

a. **Starting Engine.** If vehicle has been parked in extreme cold weather, follow instructions for cold starting outlined in paragraph 29.

(1) **SET CONTROLS.** All lever controls (transmission, transfer case, winch, etc.) must be in neutral, out, or off position. If vehicle fuel tank has been drained, refill, then work fuel pump hand primer several times. Pull out throttle control button about $\frac{1}{2}$ inch. Hold out choke button about halfway if engine is cold.

(2) **START.** Turn ignition switch to "ON" position, depress clutch pedal, then step on cranking motor lever pedal. Release pedal the instant engine fires.

(3) **SET CONTROLS.** Release clutch pedal. Push throttle button in. Release choke button after engine fires evenly.

b. **Use of Cranking Motor.** Cranking motor should not be engaged for longer periods than 30 seconds. After cranking motor has been engaged without results, a period of 10 to 15 seconds should elapse before using it again. If engine will not start after reasonable time, do not continue to use cranking motor until reason for failure is determined and corrected (par. 49). If cranking motor fails to crank or cranks slowly and battery is known to be in good condition, report failure to proper authority; then use hand cranking (subpar. c. below) or towing method (par. 23).

c. **Hand Cranking (fig. 23).** Starting crank with bracket attached is furnished with each vehicle, and is used when hand cranking or "turning over" engine. On vehicles equipped with winch, un-

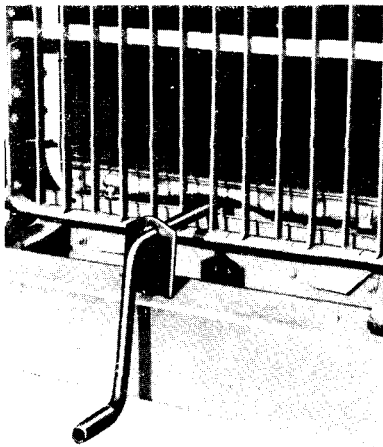

WITHOUT WINCH

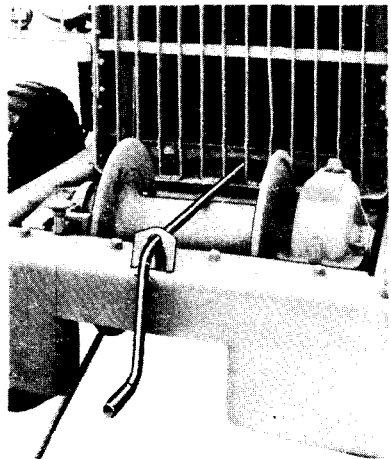

WITH WINCH

Figure 23—Use of Starting Crank

RA PD 332853

TRUCK, 2½-TON, 6 x 6

wind cable by hand (par. 24) before the starting crank is installed. After cable has been unwound, the two points or dogs of the starting crank bracket must be inserted in the holes in front bumper to position starting crank. Turn engine over several times with crank before the ignition switch is turned on. Crank engine with sharp, quick, upward pulls. Do not attempt to "wind" the engine when using the hand crank. Hand throttle should be pulled out about ½ inch, then adjusted to desired idling speed after engine has been started.

d. Engine Warm-up. Engine should be permitted to operate through a short warm-up period whenever conditions permit. This warm-up period permits the driver to observe and check performance of engine before the vehicle is placed under way.

(1) **OPERATING TEMPERATURE.** The standard thermostat starts to open at 160° F and is fully open at 185° F. Engine temperature at gage may be slightly higher than at thermostat until thermostat is fully open. Gage may register 190°F to 195°F during warm-up, then drop back to 180° F to 185° F after thermostat is completely open. The following precautions should be observed when checking temperatures during warm-up or during operation.

(a) Operating temperature should not be below 160° F in any climate. This temperature should be attained as soon as possible during warm-up. As a general rule, engine operation equivalent to 5 miles driving should bring temperature to above 160° F.

(b) Operating temperatures between 160° F and 220° F (205° F at high altitude) are satisfactory for engine operation. Temperatures above 220° F (205° F at high altitude) and below 160° F indicate improper cooling system operation.

(c) If temperature rises sharply and quickly above 220° F during warm-up or operation, stop engine and determine cause of overheating.

(d) Select correct gear range when operating to prevent engine from overspeeding (see Maximum Permissible Speed Plate, fig. 19).

(2) **OIL PRESSURE.** As engine warms up, oil pressure should recede slowly to normal, approximately 5 pounds, with engine slow idling.

e. Stopping Engine. Engine is stopped by turning ignition switch to "OFF" position.

19. DRIVING THE VEHICLE.

a. Preventive Maintenance Services. One of the most essential duties of a driver is the accomplishment of the preventive maintenance services outlined in paragraphs 41 through 45. These services, together with those recommended in section IX, New Vehicle Run-in Tests, are as important as using good driving methods.

b. Equipment Stowage. Correct stowage of equipment and tools before operating the vehicle is outlined in paragraphs 6 through 10. A thorough study should be made of methods for operation under unusual conditions as outlined in paragraphs 29 through 35, as well as instructions on the operation of auxiliary equipment (pars. 24 through 28).

OPERATION UNDER USUAL CONDITIONS

c. **Steering.** Vehicle is steered in conventional automotive manner. Steering gear, operated by steering wheel, is connected to front axle steering knuckles and tie rod through a steering arm and drag link.

d. **Use of Driving Axles and Maximum Permissible Road Speeds.** Use of driving axles and method of shifting transmission and transfer case are outlined in paragraph 16. The maximum permissible road speeds are outlined on instruction plate (fig. 19) mounted on dash. *These speeds must not be exceeded.*

e. **Braking Vehicle.** Application and release of service brakes (foot brakes) are accomplished in the conventional automotive manner. The driver applies pressure to foot pedal in varying degrees to brake vehicle as desired. Service brakes apply to all six wheels; therefore, only a normal amount of pedal pressure is required to actuate brakes, providing power system is functioning properly.

(1) **CHECKING VEHICLE SPEED.** Release accelerator pedal. Depress brake pedal slowly and evenly until vehicle is checked to desired speed. Do not "fan" pedal, but apply even pressure. This will permit the engine to assist in checking speed.

(2) **NORMAL VEHICLE STOP.** At the approach of a normal stop, release accelerator pedal, then check vehicle speed by even pressure on brake pedal. After vehicle speed is checked, depress clutch pedal, and increase pressure on brake pedal until vehicle is stopped.

(3) **EMERGENCY STOP.** Release accelerator, step sharply and hard on brake pedal, and at same time pull up on hand brake lever. Depress clutch pedal. This action should be used only in emergencies.

(4) **HAND BRAKE LEVER.** This lever should not be used to brake vehicle during normal driving. Primary purpose of hand brake is to hold vehicle in stationary position.

f. **Use of Lights.** Refer to paragraph 12 for operation of light switches.

(1) **SERVICE HEADLIGHTS.** The driver must depend upon the service headlights for night time visibility. These headlights, when aimed correctly and kept in good order, will provide adequate lighting for all conditions.

(a) **High Beam.** The high and low beams are controlled by foot-operated dimmer switch after main light switch is in service position. The high beam is generally used when there are no approaching vehicles or when operating on unlighted roadways.

(b) **Low Beam.** The low or depressed beam should be used when approaching and passing another vehicle. The low beam may not throw light far enough ahead for clear road driving; however, when another vehicle is approaching, objects between the two vehicles show up in silhouette against the road. The visibility under this condition is sometimes greater than the clear road visibility with the high beam.

(2) **BLACKOUT DRIVING LIGHT.** This light is used only under blackout conditions and is controlled by either a separate switch on instrument panel when push-pull type main light switch is used, or by a position on main light switch when rotary type is used.

TRUCK, 2½-TON, 6 x 6

(3) **BLACKOUT TAILLIGHTS.** The lens on each blackout light is designed to produce two beams which merge into a single beam at a specified distance. This design is such that when one truck is following another at a safe distance, these two beams appear as a single beam.

20. CAB SEATS, TOP, AND CURTAINS.

a. **Cab Seats.** Cab is equipped with individual seats for driver and co-driver.

(1) **DRIVER'S SEAT.** Seat back is hinged to permit back to lay forward. Seat bottom may be raised.

(2) **CO-DRIVER'S SEAT.** Seat back is also hinged; however, back engages a spring retaining clip to hold it in upright position. Seat bottom folds back on hinge and is held in back position by a sector arm.

b. **Cab Side Curtains** (fig. 24). Each side of cab is equipped with a side curtain hinged at front end of cab and latched at rear.

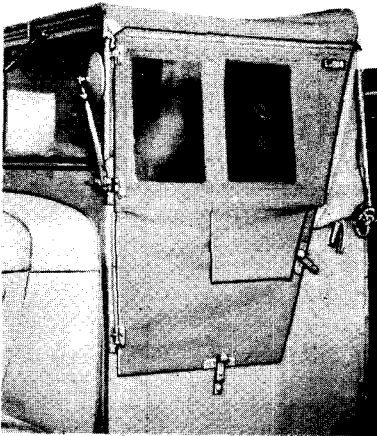

CURTAIN INSTALLED



CURTAIN STOWAGE

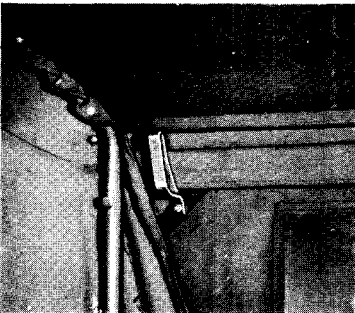

UPPER LATCH (INSIDE)



LOWER HINGE PIN

Figure 24—Side Curtain Installation

RA PD 332869

OPERATION UNDER USUAL CONDITIONS

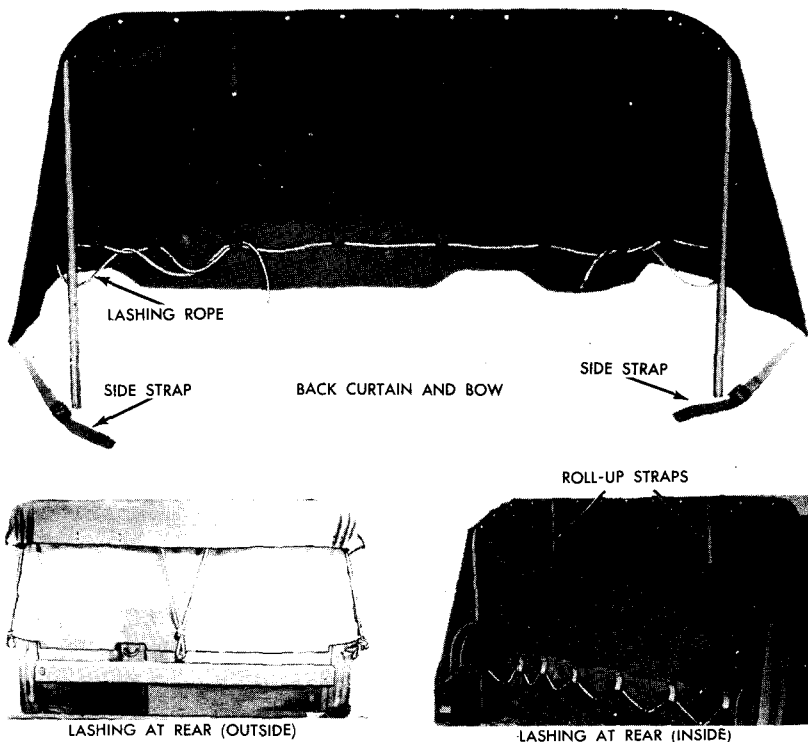

RA PD 332930

Figure 25—Top and Back Curtain Installation

Upper curtain latch can be operated from inside or outside of cab. Lower latches can be operated from inside of cab by reaching through curtain hand hole.

(1) **REMOVAL.** Unlatch curtain and swing open about 90 degrees. Lift curtains straight up to disengage hinge pins from hinge brackets. Lower hinge pin is flat and engages like portion of hinge bracket.

(2) **INSTALLATION.** Hold curtain in open position with hinge side to windshield. Insert curtain hinge pins in corresponding hinge brackets. Push downward on curtains to engage pins in brackets, then swing curtain against cab.

(3) **STOWING CURTAINS.** Stow curtains, when not in use, in compartment behind driver's seat back.

c. Cab Top Deck. Cab top deck is one-piece type with side rails (latest type) to hold top rigidly when installed.

(1) **REMOVAL.** Untie lashing from top bow ring nut at rear of cab on each side. Unhook rope loop from cab rear lashing hook. On latest type, disengage side rail pin from top bow at each side. Lift top deck over top bow, and pull over windshield. Remove catch

TRUCK, 2 1/2-TON, 6 x 6

from eye at each upper corner of windshield. From either side, pull top canvas from channel in top of windshield frame.

(2) **INSTALLATION.** Slide front end of top deck into channel in top of windshield frame. Draw deck over rear top bow. Insert side rail pin into bow hole at each rear side. Hook rear lashing rope loop over hook at rear of cab. Hook front corners of deck over eyes on upper corners of windshield frame, then place strap hook through eyes. Lash rear sides of deck to top bow ring nut.

d. Back Curtain (fig 25). Back curtain is one-piece canvas. Top portion is attached by metal screws. Each leg of the top bow fits into a socket at inside rear of cab. The bow is held in upright position with a top bow ring nut on each side. Lashing rope, looped through lower inside end of curtain, is lashed to a series of hooks attached to cab in back of seats, with ends of ropes lashed to hooks on outside of cab at each side. Lower sides of curtain are strapped to cab at inside.

(1) **REMOVAL.** With top deck removed or rolled forward, unlash back curtain at sides (rope and straps), unhook rope at back of seats, then remove cotter pin from each leg of bow. Loosen each top bow ring nut, and pull bow and curtain straight up from sockets.

(2) **INSTALLATION.** Insert bow in sockets, then insert cotter pin into each leg of bow. Holding bow in upright position, tighten ring nut on each side of cab. Hook rear lashing rope on hooks at inside rear of cab. Lash each end of rope to hook on each side of cab. Attach side straps to loops inside of cab.

e. Positioning Top and Back Curtain for Accessibility (fig. 26).

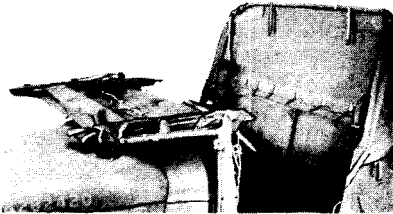

TOP OVER WINDSHIELD

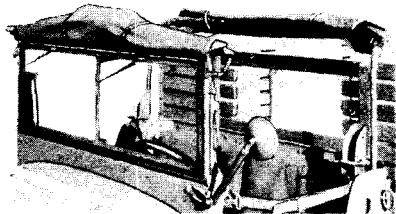

TOP AND BACK CURTAIN ROLLED

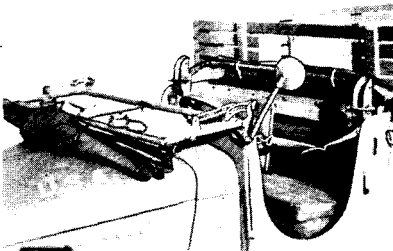

TOP ROLLED AND BACK CURTAIN DOWN

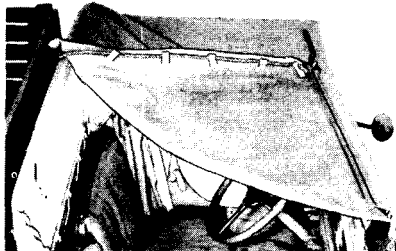

TOP CURTAIN TURNED BACK

RA PD 332898

Figure 26—Top and Back Curtain Operating Positions

OPERATION UNDER USUAL CONDITIONS

Top deck and back curtain may be placed in various positions for ventilation or accessibility.

(1) **TOP DECK OVER WINDSHIELD (To Prevent Glare).** Release top deck at back and fold over windshield.

(2) **TOP DECK AND BACK CURTAIN ROLLED.** Release top deck at back, fold side channels, then secure roll with front roll-up straps. Unhook back curtain at sides and bottom, roll up to top of bow, then secure roll with roll-up straps.

(3) **TOP DECK ROLLED AND BACK CURTAIN BOW DOWN.** Roll top deck and back curtain as explained in step (2) above. Unscrew side top bow ring nuts, and allow bow to slide down in sockets.

(4) **TOP DECK CORNER TURNED BACK.** Release rear rope and front fastener on one side. Fold one corner of top deck over top.

21. CARGO BODY TARPAULINS.

a. Tarpaulins used with cargo and cargo dump bodies, and as camouflage equipment on gas and water tank bodies, consist of a separate top tarpaulin, front end curtain, and rear end curtain. Top tarpaulin is supported by bows which are fitted into pockets in cargo racks. The methods described in following subparagraphs permit the removal, folding, and installation of tarpaulins in shortest possible time.

b. **Removal** (figs. 27, 28, and 29).

(1) Untie all side and rear top tarpaulin lashing ropes. If these were tied correctly, it will be only necessary to pull free end of each rope. Front and rear curtains may or may not be removed at this time.

(2) With all top tarpaulin ropes untied, make first fold on each side lengthwise until lower edge of tarpaulin is even with top buckles.

(3) Make second fold lengthwise on both sides until both folds meet.

(4) Bring one folded side over the other fold.

(5) At each end, make an equal fold toward the center.

(6) Make another equal end fold until folded tarpaulin is laying across center bow.

c. **Installation.** Reverse procedures as described in subparagraph b above.

d. **Stowing Tarpaulins.** Do not fold or stow tarpaulins if they are wet.

e. **Folding Top Tarpaulin for Ventilation.** Untie all top tarpaulin ropes. At each side, fold tarpaulin under three folds. Straps on bows may then be lashed to buckles on tarpaulin. Tie front and rear draw ropes to lashing hooks at each end of body.

22. WINDSHIELD OPERATION.

a. **Tilted Position** (fig. 30). Loosen the upper adjusting thumb screw on each side. Push windshield outward at bottom to desired angle, then tighten thumb screws.

TRUCK, 2½-TON, 6 x 6

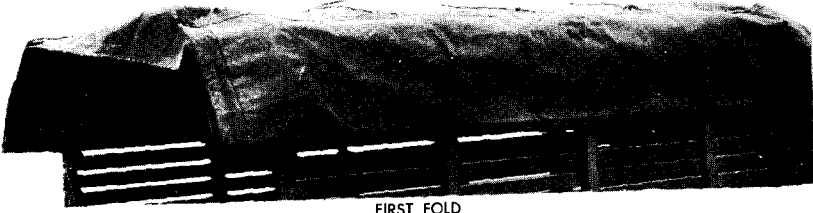

FIRST FOLD

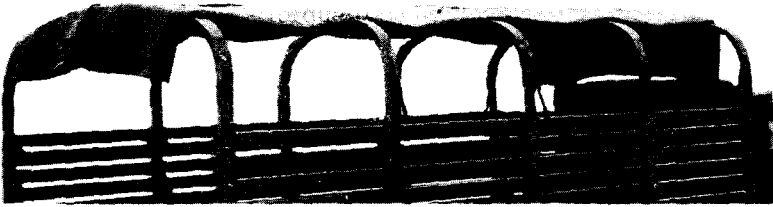

SECOND FOLD

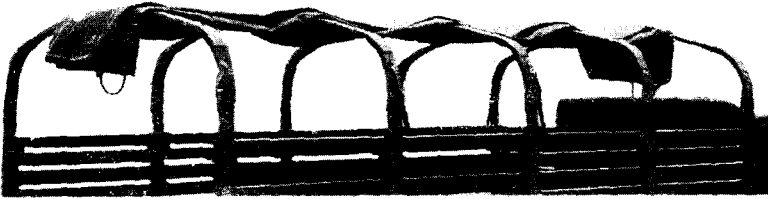

THIRD FOLD

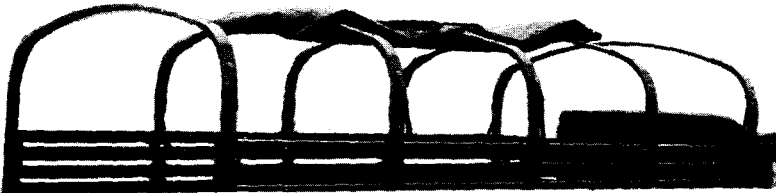

FOURTH FOLD



FINAL FOLD

RA PD 332943

Figure 27—Method of Removing Top Tarpaulin

OPERATION UNDER USUAL CONDITIONS

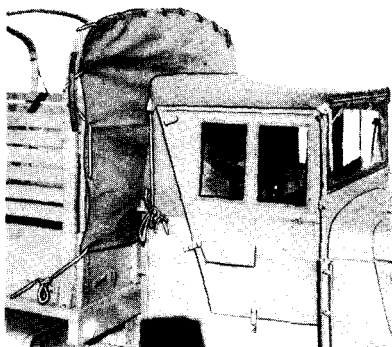

FRONT CURTAIN LASHED

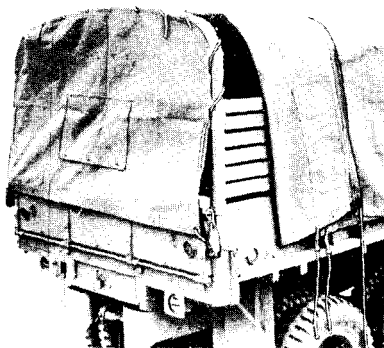

REAR CURTAIN LASHED

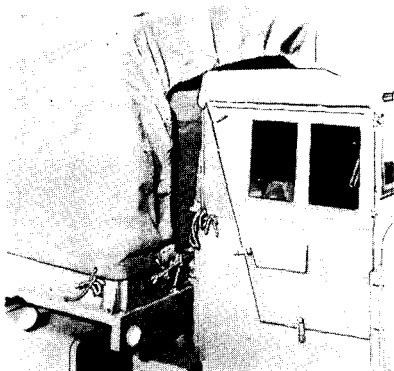

TOP TARP LASHING AT FRONT

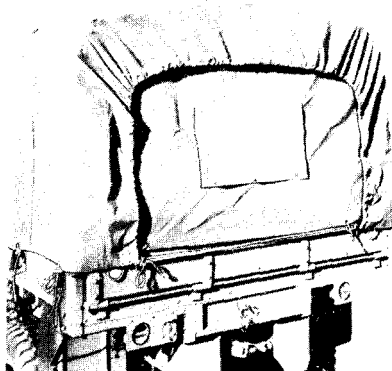

TOP TARP LASHING AT REAR

RA PD 332892

Figure 28—Lashing at Front and Rear

b. **Lowered Position** (fig. 30). Cab top must be either disconnected from windshield and folded back, or unhooked from rear of cab and folded forward before windshield can be lowered. Loosen



RA PD 332899

Figure 29—Tarpaulin Raised in Ventilating Position

TRUCK, 2½-TON, 6 x 6

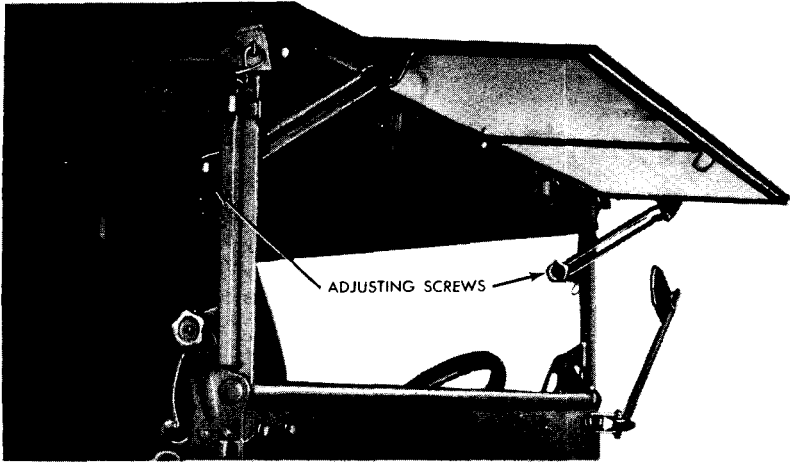

TILTED POSITION

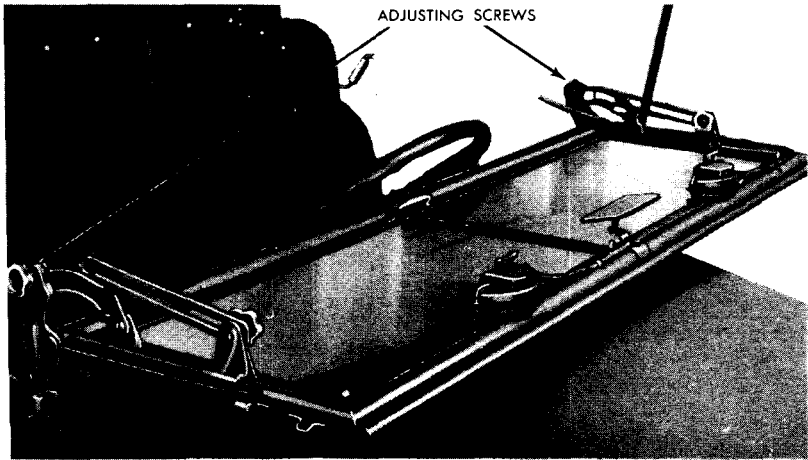

LOWERED POSITION

RA PD 332907

Figure 30—Windshield Operating Positions

lower thumb screw nuts. Lay windshield forward into position, then tighten thumb screw nuts.

23. TOWING THE VEHICLE.

a. **Towing to Start.** Engine may be started by towing vehicle with another vehicle in the following manner:

(1) Tow chain or line should be of sufficient length to permit maneuverability of both vehicles.

(2) In towed vehicle, pull throttle button out about ½ inch. Hold choke out part way if not previously used. Place transmission

OPERATION UNDER USUAL CONDITIONS

in fourth speed. Place transfer case in high. Do not engage front axle.

(3) Turn on ignition switch.

(4) While being towed for the first 100 feet, hold clutch in disengaged position. When towed vehicle speed reaches approximately 10 miles per hour, slowly engage clutch.

(5) Disengage clutch immediately after engine starts.

b. Towing Damaged Vehicles. Particular care must be exercised when towing damaged vehicles to repair bases to make certain that no additional damage occurs while vehicle is being towed.

(1) **TOWING VEHICLES WITH ALL WHEELS ON GROUND.**

(a) If transfer case on vehicle to be towed is not damaged, shift transmission and transfer case in neutral position. In this position, gears in transmission are not in motion; however, driving gears are revolving in transfer case, and gears will cause enough lubricant splash to provide lubrication for pocket bearings and main shaft bushings.

(b) If transfer case is damaged, propeller shafts should be disconnected at front axle pinion, forward rear axle pinion, and pillow block. Secure shafts to frame. Place bolts, nuts, and bearings in compartment in the cab.

(2) **TOWING VEHICLE WITH FRONT WHEELS OFF GROUND.** Whenever vehicle is to be towed with front wheels off ground, vehicle must be supported in such a manner that wheels of forward rear axle contact ground. Disconnect propeller shafts at forward rear axle and pillow block. Secure ends of shafts to frame.

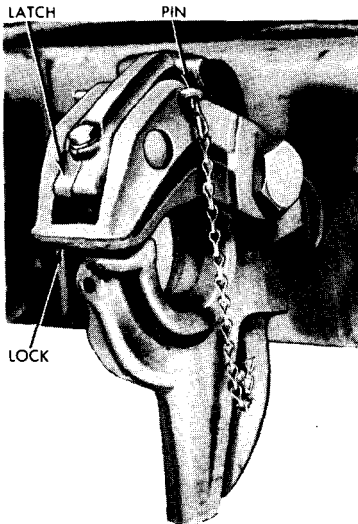

CLOSED

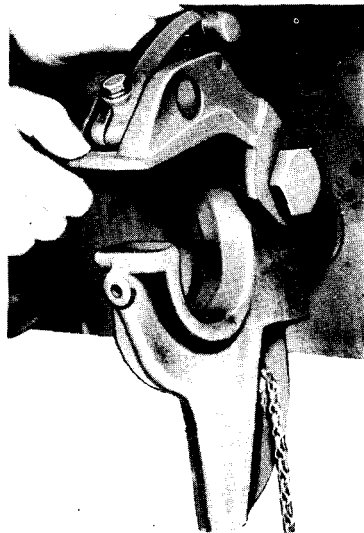

OPENING

Figure 31—Pintle Hook Operating Positions

RA PD 332894

TRUCK, 2 1/2-TON, 6 x 6

(3) TOWING VEHICLE WITH REAR WHEELS OFF GROUND. Vehicle should be towed backward only after other methods have proven unsatisfactory. When towing vehicle backward, make certain that front axle declutching lever is placed in "OUT" or disengaged position.

c. **Use of Pintle Hook** (fig. 31). To open, remove pin, then lift up latch and pull up lock with hand. To close, push down lock. Latch will then be placed. Insert pin.

Section VI

OPERATION OF AUXILIARY EQUIPMENT

24. WINCH OPERATION.

a. **General.** Winch assembly, when used, is mounted forward of radiator between frame side rail extensions. The unit is driven by transmission power take-off through a drive shaft extending from power take-off to winch worm shaft housing. Winch may be used on short or long wheelbase chassis (CCKW-352 and 353) equipped with cargo body, and long wheelbase chassis equipped with cargo dump body (CCKW-353-H1 or H2). Winch is not used on chassis equipped with water or gas tank bodies.

b. Controls.

(1) **POWER TAKE-OFF.** The engagement of the power take-off is manually accomplished by means of a lever which extends through the floor pan in the cab (fig. 33). This lever has three operating and two neutral positions in following order from rear of cab toward front:

(a) *When Winch Only Is Used* (fig. 33). Low ("L"), neutral ("N"), reverse ("R"), neutral ("N"), and high ("H").

(b) *When Winch and Power Hoist Are Used.* Reverse ("R"), neutral ("N"), low ("L"), neutral ("N"), and high ("H").

(c) **Control Lever Catch** (fig. 33). A hinge plate attached to floor board beside lever provides positive means of locking lever into a neutral position. This arrangement will prevent accidental engagement of power take-off. The lever can be locked in the neutral position between high ("H") and reverse ("R") when winch only is used, and between reverse ("R") and low ("L") when winch and power hoist are used.

(2) **WINCH CONTROLS.** An automatic safety brake on the winch worm shaft will sustain load while the winch power take-off control lever is being shifted into various positions. A manually operated shift yoke at the winch is used to engage and disengage winch drum.

(a) **Safety or Under Way Position.** When vehicle is under way and winch is not operating, shift yoke must be placed into engaged position (fig. 32). Cable then will not unwind from drum while vehicle is under way.

OPERATION OF AUXILIARY EQUIPMENT

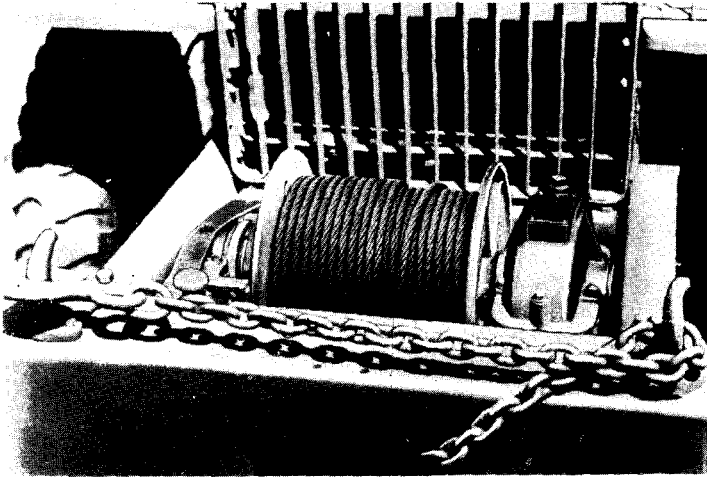

WINCH INSTALLED

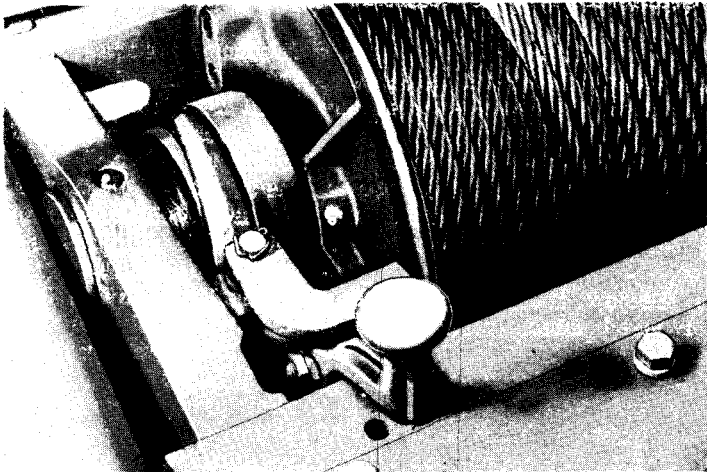

CONTROLS AT WINCH

RA PD 332919

Figure 32—Controls at Winch

(b) *Hand Winding Position.* When necessary to wind or unwind the cable by hand, place shift yoke into disengaged position with handle poppet engaged in hole. Cable drum may then be revolved by hand.

(c) *Operating Position.* When winch is to be operated by power take-off, place shift yoke into engaged position.

c. **Operating Winch. Important:** The winch will be more powerful with all cable off the drum before it starts to operate. Under many conditions, this is not possible; however, the best procedure

TRUCK, 2½-TON, 6 x 6

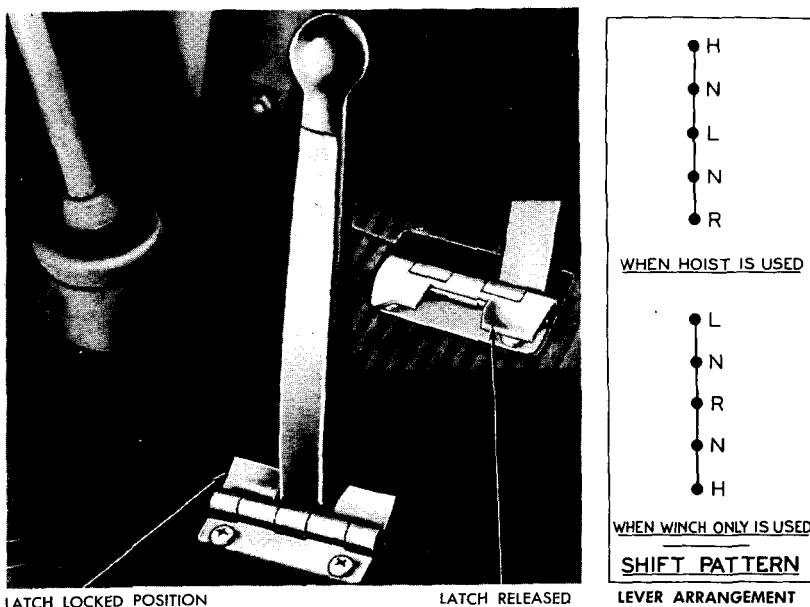

Figure 33—Winch P.T.O. Control Lever

to use is to pay-out as much cable as possible from the winch drum before starting to pull.

(1) To Hook On. Place shift yoke into disengaged position (fig. 32). Pull out enough cable to make hook-up.

(2) To PULL (WIND IN). After hook-up has been made, place shift yoke into engaged position (fig. 32). Depress engine clutch pedal, place winch power take-off control lever in low ("L") if load is heavy, or into high ("H") to take up slack if load is light. Release clutch pedal, then accelerate engine to proper speed (step (a) below).

(a) Pulling Speeds. Winch pulling speeds are based on a maximum engine speed of 1,000 revolutions per minute. This speed must not be exceeded when operating winch. Operating at a faster speed will result in excessive strains and probable failure of parts.

(b) Use of Power Take-off Low and High Ranges. Use high ("H") range when handling light loads and low ("L") range when handling heavy loads. Do not race engine when winching, particularly when handling light loads or when winding cable with no load.

(3) To LOWER (PAY-OUT).

(a) With Load. With shift yoke in engaged position, depress clutch, place winch power take-off control lever into reverse ("R") position, release clutch, and accelerate engine to desired speed.

(b) Without Load. It is not necessary to use power take-off engagement if cable is to pay-out without load. Place shift yoke in disengaged position.

OPERATION OF AUXILIARY EQUIPMENT

(4) **WINDING CABLE.** Cable should not be wound on drum without some load. Winding on first layer of cable is most important. Coils of cable must be tight against each other to prevent coils on next layer from pressing down between them. Cable should be wound on drum evenly and slowly to obtain this result. After first layer is wound evenly, it is necessary to see that each additional layer starts back across drum properly. Two methods of winding cable can be used (steps (a) and (b) below).

(a) *With Load on Cable.* Cable should be properly attached to an anchor or tree and vehicle pulled forward by winch. A very light pressure on vehicle brake by operator while winding cable will insure a tight, neat wind.

(b) *With Winding Fixture.* A fixture such as illustrated in figure 34 may be used to maintain slight tension on cable when it is guided into drum. This fixture is not a special tool and can be made up locally. Two main sections can be made from heavy lumber such as 2x4 strips or larger. The guide block is of metal approximately 4x4x6 inches, split through drilled hole to permit insertion of cable and split bushing. It is tightened by means of stud with a large wing nut to obtain desired cable tension. End of fixture may be securely clamped to front bumper with a hooked bolt or C-clamp as shown. Pivot point is at ground level. This will permit swinging free arm, with guide block, back and forth to guide cable and wind it in even layers on drum.

(5) **USE OF DRIVING WHEELS WITH WINCH.** If vehicle is assisting itself with its own winch, all driving wheels should be utilized. Always start wheels operating the instant winch cable starts to take the load; in other words, do not start driving wheels if there is a slack in winch cable. When driving wheels are used to assist winch operation, power take-off lever must be in low ("L"), transmission in low, and transfer case in low range.

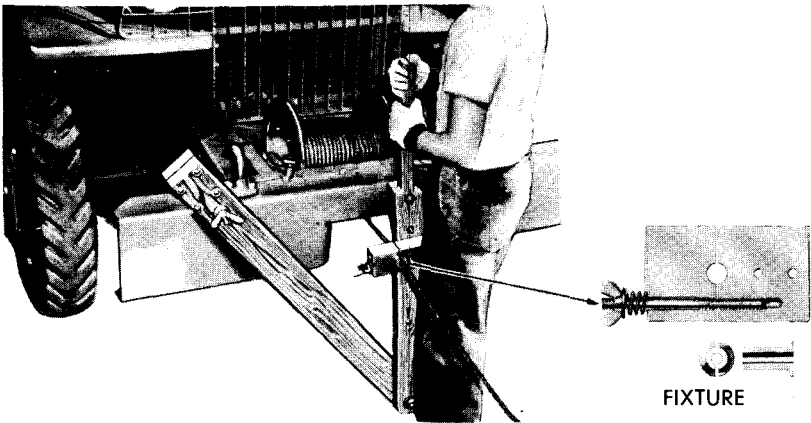
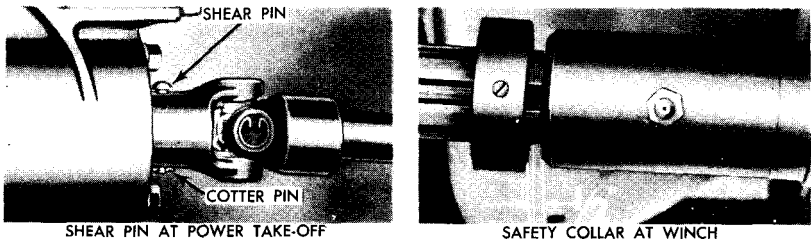

Figure 34—Use of Fixture to Wind Cable

RA PD 64674

TRUCK, 2 1/2-TON, 6 x 6



RA PD 332870

Figure 35—Safety Shear Pin Installation

(6) **SAFETY SHEAR PIN REPLACEMENT.** One safety shear pin is used to connect the winch front drive shaft universal joint to the winch worm shaft. This pin is designed to shear when the winch is loaded beyond its capacity. Spare pins are furnished with the vehicle and are stowed in the compartment underneath co-driver's seat. Use the regulation shear pin, do not use a substitute. Replace shear pin in following manner:

(a) *Move Safety Collar* (fig. 35). Loosen set screw in safety collar located at slip joint at power take-off. Slide collar away from slip joint.

(b) *Remove Sheared Pin.* Slide front universal joint back on winch worm shaft, at winch, until sheared portion of pin is exposed in worm shaft. With a punch, drive portions of pin from winch worm shaft and universal joint yoke.

(c) *Install Shear Pin.* Apply a small amount of chassis grease to end of winch worm shaft; then slide universal joint yoke over end of winch worm shaft. Aline shear pin hole in shaft with yoke. Install shear pin and secure with new cotter pin (fig. 35).

(d) *Position Safety Collar.* Locate safety collar so that a space of 1/2 inch exists between collar and yoke. Tighten collar set screw.

(7) **RIGGING.** Reference should be made to authoritative manuals on rigging and the use of snatch blocks. Rigging should be placed, whenever possible, to permit straight pull from winch.

25. CARGO DUMP BODY OPERATION.

a. General. The combination cargo-dump body is an all-steel body, which can be used either as a cargo or dump unit. A hydraulic hoist and subframe assembly, mounted on the chassis under the body, elevates the body when being used as a dump truck. Controls for operation of the hoist are located in the cab. Hoist pump, when engaged, is driven by transmission power take-off through drive shafts connecting power take-off with hoist pump.

b. Hoist Operation.

(1) **GENERAL.** Hoist should only be used when body is being used for dumping purposes. Do not operate hoist pump when vehicle is in motion. Controls for the operation of the hoist consist of two levers, located in cab. One lever is used only to engage power

OPERATION OF AUXILIARY EQUIPMENT

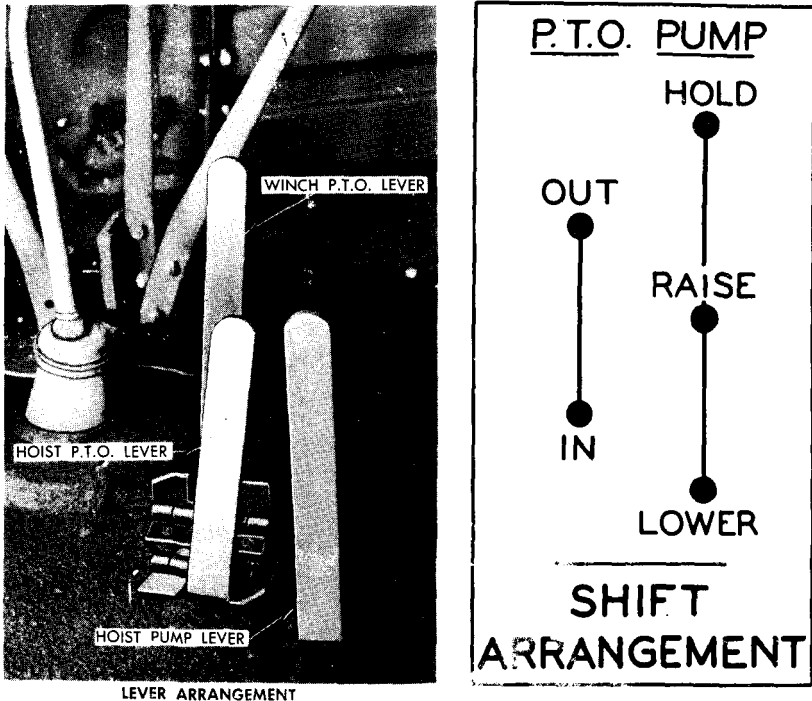

Figure 36—Hoist Control Levers and Shifting Arrangements

RA PD 332941

take-off and start pump operating. Other lever controls pump action, and is used only to raise, hold, or lower the body.

(2) To RAISE BODY.

(a) *Engage Power Take-off* (fig. 36). With engine running at slow idle, depress clutch pedal and move power take-off hoist control lever rearward into "IN" position, then release clutch pedal.

(b) *Engage Pump* (fig. 36). With power take-off engaged (step (a) above), move hoist control valve lever ("PUMP") into center ("RAISE") position. Accelerate engine only sufficiently to raise body. Racing the engine does not increase dumping speed, and may cause damage to pump or force air into system. When hoist has reached its full stroke, it will stop automatically; however, the clutch pedal should be depressed and power take-off control lever moved to "OUT" position.

(3) To HOLD BODY. Body can be held in any intermediate position during raising or lowering by shifting hoist control valve lever to "HOLD" position.

(4) To LOWER BODY. Engine need not be running to lower body. Place hoist control valve lever ("PUMP") in "LOWER" position. Body will return to horizontal position. Lowering speed should not

TRUCK, 2½-TON, 6 x 6

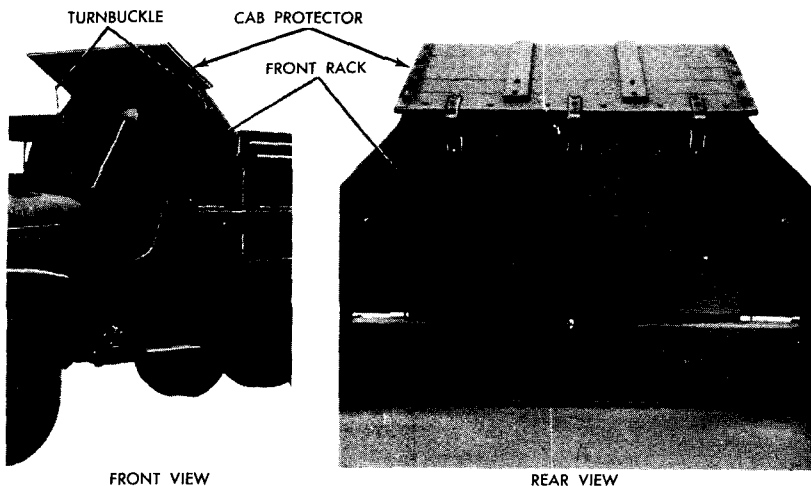

Figure 37—Cab Protector Raised

RA PD 332863

be excessive and may be controlled by moving valve lever slightly forward.

(5) **UNDER WAY.** Power take-off control lever must be in "OUT" (not engaged), and hoist control valve lever in "LOWER" position when truck is under way (except when spreading) (subpar. d below).

c. **Body.**

(1) **AS A DUMP BODY.** Before using the vehicle as a dump truck, it is necessary that alterations be made as outlined in steps (a) through (e) following.

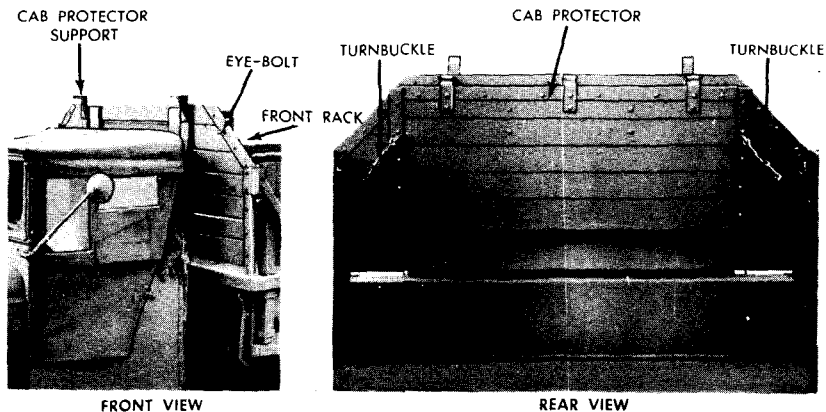
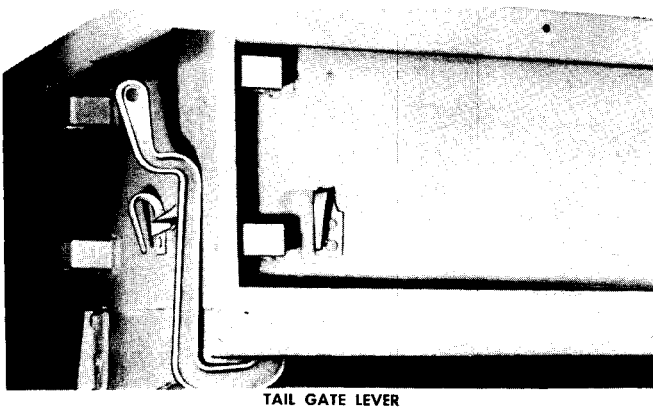
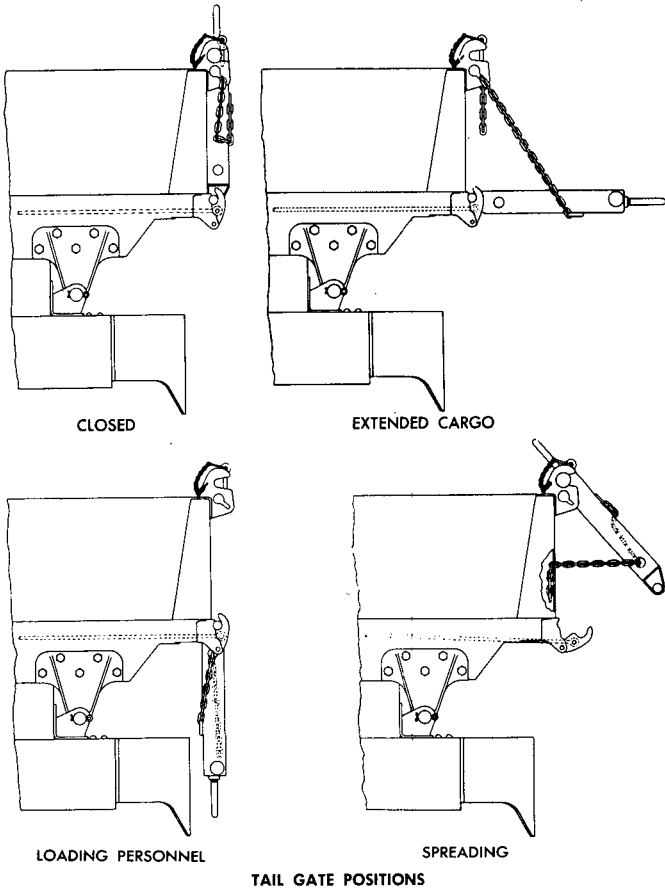

Figure 38—Cab Protector Lowered

RA PD 333005

OPERATION OF AUXILIARY EQUIPMENT



RA PD 332938

Figure 39—Tail Gate Lever and Tail Gate Positions

TRUCK, 2½-TON, 6 x 6

(a) *Remove Tarpaulins.* Untie and remove all tarpaulins and end curtains.

(b) *Remove Seat and Side Rack Assemblies.* Tag right- and left-hand assemblies for identification at installation, then remove each assembly.

(c) *Adjust Cab Protector* (figs. 37 and 38). Loosen cab protector turnbuckles at rear of front rack. Turn cab protector forward until it extends over top of cab. Install turnbuckle hooks through eye bolts in front rack. Tighten turnbuckle.

(d) *Adjust Tail Gate* (fig. 39). Tail gate is adjustable to several positions. When used as a dump body, tail gate must be locked at top with pins so that when dumped, gate will open at bottom. Tail gate chain can be positioned to control opening of gate to obtain desired spreading results.

(e) *Raise Floor Partition.* Raise partition in floor and lock in an upright (vertical) position (fig. 40), with bolts at each end through holes in body sides. **NOTE: It is extremely important that partition be raised, as this minimizes the possibility of overloading and distributes weight of load properly. Do not use body as dump body until partition has been raised.**

(2) **AS A CARGO BODY.** Before using the vehicle as a cargo truck, all items removed in steps (1) (a) through (1) (e) should be re-installed or adjusted to their original position. Refer to figure 39 for various tail gate positions and figure 38 for cab protector in folded position.

d. Spreading. When desired, the tail gate opening can be adjusted to limit the opening, thereby limiting the flow of material being spread (fig. 39).

(1) Thread loose ends of tail gate chains into holes in rear corner post. Adjust chain length to limit tail gate opening. Install pins at each upper corner of tail gate so that gate will hinge at top.

(2) Engage power take-off *before vehicle is in motion and engine running at slow idle* as directed in subparagraph b (2) (a) above.

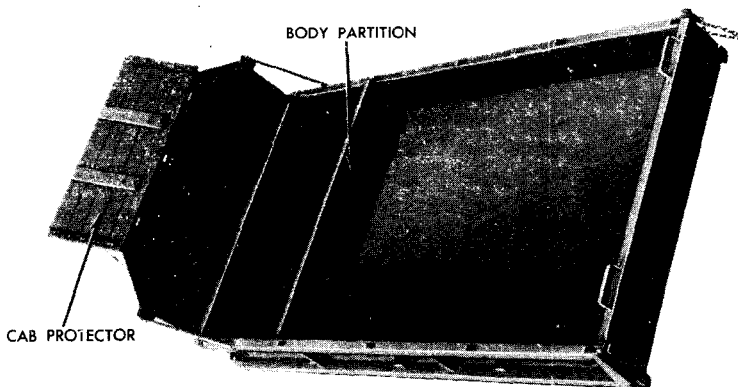

Figure 40—Body Partition in Place

RA PD 332843

OPERATION OF AUXILIARY EQUIPMENT

(3) Pull tail gate control lever forward and down to unlatch tail gate. Engage pump (subpar. b (2) (b) above), and raise body two or three feet, or just enough so that material does not start to spill out of tail gate.

(4) Place hoist control valve lever ("PUMP") in "HOLD" position (fig. 36).

(5) Place transmission shift lever into 1st speed, transfer case into low range, then with power take-off lever still engaged, release clutch to set truck in motion. Transmission speeds used during spreading operations are dependent upon road conditions and material being spread. As a general rule, engine should not be operated at excessive speed, as this also increases pump speed and may cause damage to pump or force air into system.

(6) Raise body at intervals by moving valve control lever to "RAISE" position, then back to "HOLD" position. Repeat this operation as required to cause free flow of material.

(7) When unloaded, stop truck and disengage power take-off by moving lever to "OUT" position.

(8) Lower the body by moving valve control lever to "LOWER" position. Push tail gate lever upward and rearward to lock tail gate.

26. WATER TANK BODY OPERATION.

a. **General** (figs. 41 and 42). The 700 gallon water tank, mounted on long wheelbase chassis, is equipped with an auxiliary engine and pump unit. Water can be unloaded from truck by gravity or by pump. Water is loaded into the tank from any source by pumping unit. Tank is insulated and is lined with special composition. Water may be heated with portable gasoline type heater inserted directly

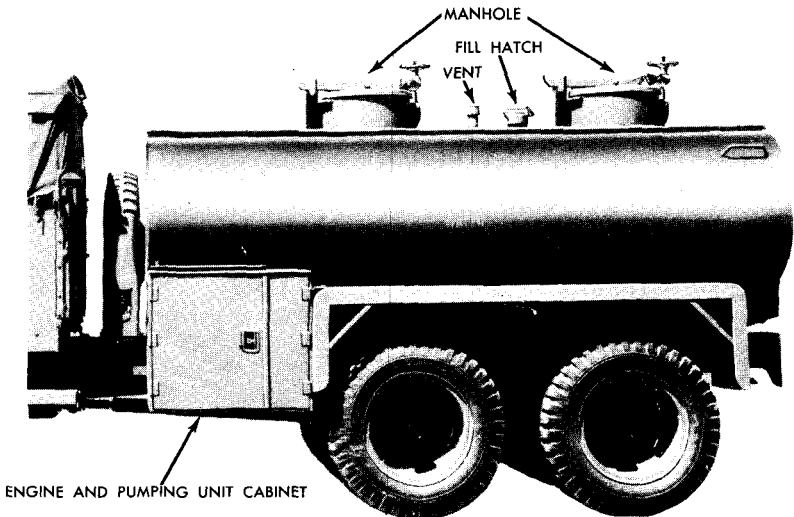

Figure 41—Water Tank Body

RA PD 332867

TRUCK, 2 1/2-TON, 6 x 6

- A MANHOLE COVER
- B MANHOLE COLLAR
- C MANHOLE PLUG
- D HANDWHEEL
- E HEATER
- F HEATER GAS TANK
- G EMERGENCY VALVE
- H EMERGENCY VALVE OPERATOR
- I PUMP ENGINE
- J PUMP ENGINE GAS TANK
- K PUMP
- L SUCTION HOSE RACK
- M EQUIPMENT CHEST
- N VENT
- O FILL HATCH
- P GATE VALVE
- Q HOSE CONNECTION NIPPLE
- R STOP
- S PUMP OUTLET PORT

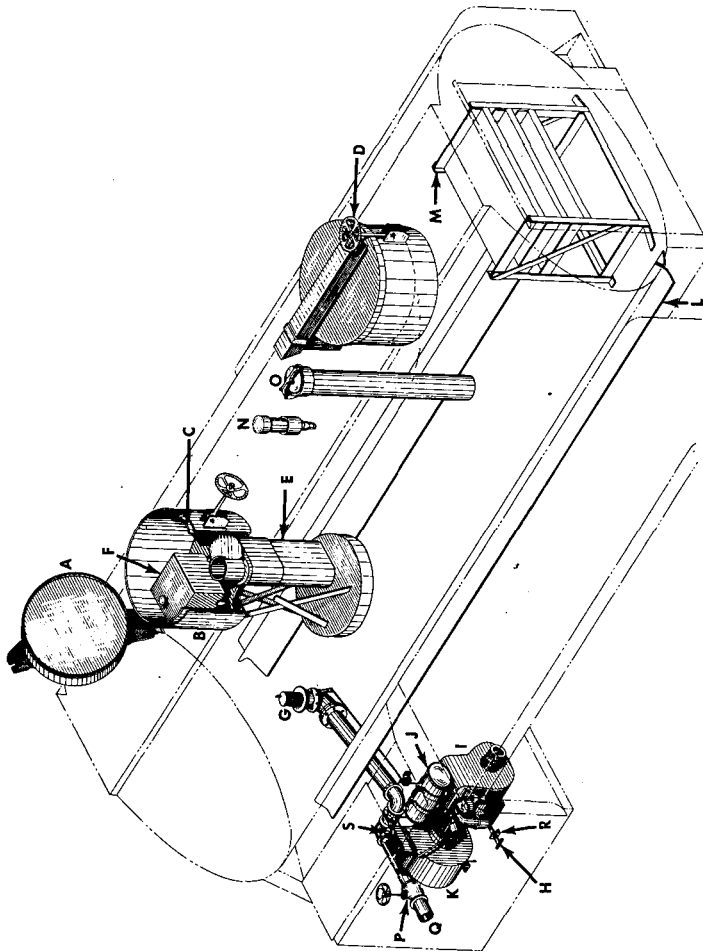

Figure 42—Water Tank Body Controls

RA PD 333013

OPERATION OF AUXILIARY EQUIPMENT

into heater through a manhole, or by exhaust heat through a connection from vehicle exhaust system.

b. Equipment. Equipment cabinet at rear of body contains necessary discharge hoses and tools for the operation and maintenance of various controls. Lengths of suction hose are stowed on racks on side of body. Auxiliary engine and pumping unit is housed in compartment at left front side of body.

c. Auxiliary Engine and Pumping Unit. The pumping unit consists of a self-priming centrifugal pump mounted on a common base with, and driven by a single-cylinder, four-cycle, air-cooled gasoline engine. The impeller of the pump is attached directly to the engine crankshaft. Engine is self-lubricated and is equipped with separate fuel tank. Refer to manual which accompanies the pumping unit.

(1) **AUXILIARY ENGINE OPERATION.** Before auxiliary engine is started, its fuel tank and crankcase must be filled. In addition, pump controls must be set to desired position (subpar. d below), before engine is started.

(2) **STARTING ENGINE.**

(a) Fill crankcase of engine with seasonal grade crankcase oil (approx. 1 $\frac{3}{4}$ pints).

(b) Close shut-off valve in gasoline line, then fill fuel tank with a good quality gasoline (same as used in truck).

(c) Open fuel line valve, then close choke on carbureter air inlet horn. Turn choke lever away from engine.

(d) Carbureter needle valve opening is approximately $\frac{3}{4}$ to 1 $\frac{1}{4}$ turns. In cold weather, starting may be facilitated by opening the needle valve slightly more, then adjusting needle after engine has started.

(e) Insert knot of starter rope in the notch in starting sheave at flywheel end of engine, then wind the rope on sheave in clockwise direction. Pull briskly on rope to turn the crankshaft over.

(f) If engine does not start immediately, repeat operation (step (e) above). If choke in carbureter snaps open during hand cranking, close choke again for two or three turns of engine. If fuel begins to drip from carbureter, choke should be opened.

(g) When engine has started, flyball type governor will limit engine to set speed.

(3) **STOPPING ENGINE.** Press red stop button, located on magneto, for a few seconds until engine stops, then release pressure on button. Engine can then be restarted if desired (step (2) above).

(4) **PRIMING PUMP.** Remove plug at top of pump body and fill pump full of clean water. Replace plug. The pump will then reprime automatically until it is necessary to drain the priming chamber.

(5) **DRAINING PUMP.** During cold weather, pump housing should be drained if vehicle is to be parked. Close emergency valve and suction pipe gate valve. Place cap over end of discharge pipe. Remove plug from bottom of pump housing and drain all water from housing.

d. Operating Pump (fig. 42). Pump may be operated to dis-

TRUCK, 2½-TON, 6 x 6

charge water from tank, to pump water into tank, or using pump unit to fill another water tank from an outside source.

(1) PUMPING FROM TANK.

- (a) Connect discharge hose to outlet port.
- (b) Close suction pipe gate valve.
- (c) Open emergency valve (pull out handle).
- (d) Start engine.

(2) PUMPING INTO TANK.

(a) Connect one end of discharge hose to outlet port and place the other in fill hatch after opening hatch cover.

(b) Connect suction hose to suction pipe nipple, then open gate valve.

- (c) Close emergency valve (handle in).
- (d) Start engine.

(3) USING PUMP UNIT TO FILL ANOTHER TANK.

(a) Close emergency valve (handle in).

(b) Connect suction hose to nipple, then open gate valve. Connect discharge hose to discharge port.

(c) Start engine.

e. **Emptying Tank by Gravity.** Place cap on discharge port. Connect suction hose to nipple, then open gate valve. Pull open emergency valve. Water will then flow out of tank through suction hose.

f. Heating Equipment.

(1) **EXHAUST HEATER.** The vehicle exhaust system is bypassed through a heater box in water tank. The exhaust bypass valve is manually operated by a control mounted on the dash panel to left of steering wheel. Pull control handle out to open bypass valve. **CAUTION:** *Always close exhaust bypass valve (handle in) when operating with empty tank. Operating with valve open while tank is empty will cause damage.*

(2) **PORTABLE IMMERSION HEATER** (fig. 43). A torch type portable immersion heater is installed into tank through rear manhole on some tank bodies. This heater remains in tank, and when heater stack is removed, manhole can be closed and latched. Heater operates on gasoline, kerosene, or distillate. Operate heater in following manner:

(a) Fill heater tank with fuel.

(b) Install three lengths of stack over exhaust port. Stack sections are stowed on side of body in a rack.

(c) Pull up torch from heater unit. Saturate torch with fuel, then light.

(d) Lift damper, then insert lighted torch into intake compartment, passing torch through opening in bottom damper opening into exhaust compartment. Offset in torch rod will permit this manipulation of torch. Lower damper, permitting it to rest on torch handle.

(e) Permit torch to burn in above manner for about 20 to 30 seconds; then lift damper and shift torch from exhaust compartment straight down to top of burner in intake compartment.

OPERATION OF AUXILIARY EQUIPMENT

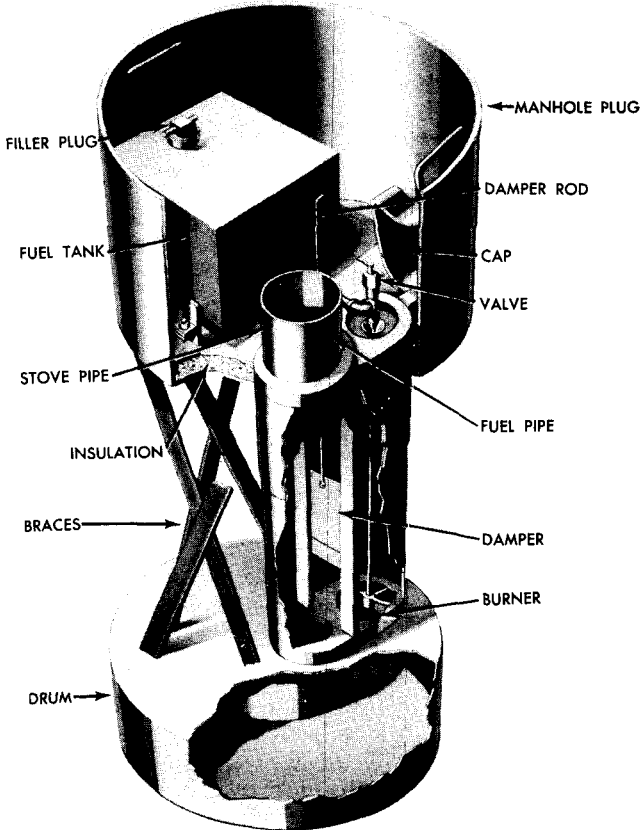

Figure 43—Immersion Heater

RA PD 332809

(f) Open fuel valve, below fuel tank, allowing a fast drip.

(g) After burner has operated for one minute, the fuel valve can be set for desired speed. The minimum speed is 20 drops per minute. Maximum speed is slightly under a stream. Smoke will appear from stack when speed is too fast.

(h) Heater can be lifted from manhole as a unit. When heater is removed, a manhole plug, such as used in the front manhole, must be inserted in place of heater unit.

27. GASOLINE TANK BODY OPERATION.

a. **General.** Gasoline tank body, mounted on long wheelbase chassis (CCKW-353) comprises two tanks, each of 375 gallon capacity, together with manually operated lever controls for the independent discharging of each tank. Each tank can be filled through a manhole located at top of tank.

TRUCK, 2 1/2-TON, 6 x 6

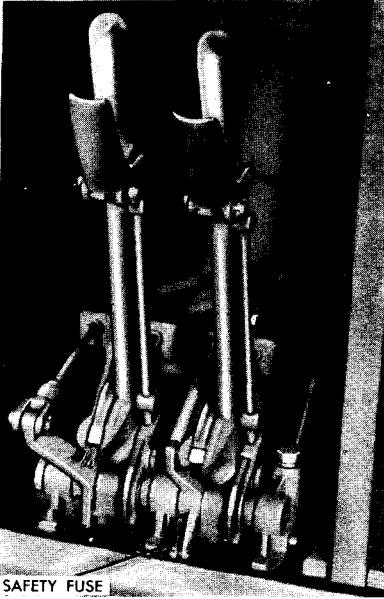

SELECTIVE OPERATOR VALVE CONTROLS

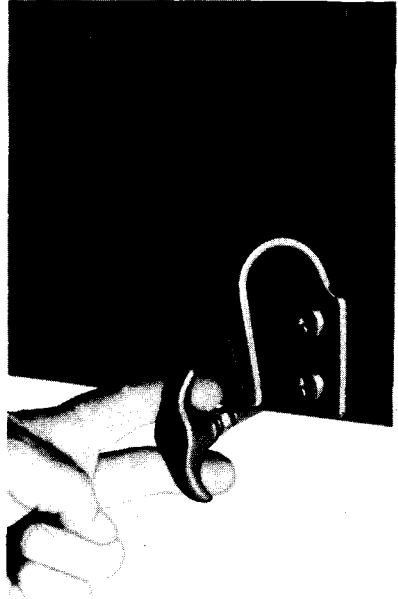

FRONT END TRIP RELEASE

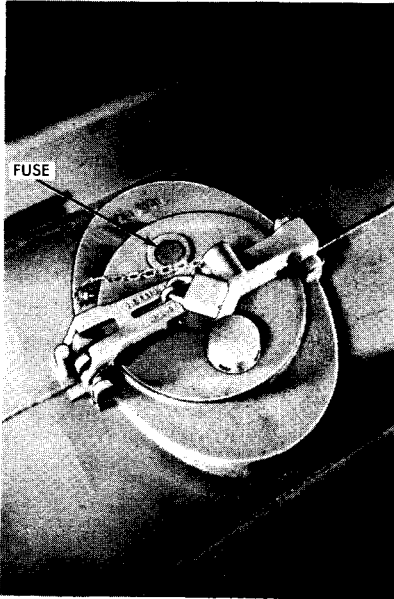

MANHOLE COVER AND VENT

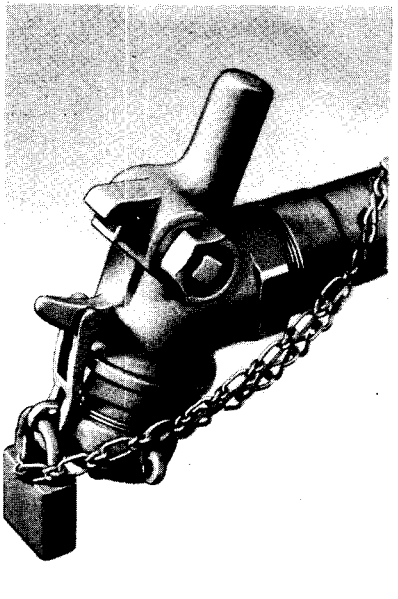

DISCHARGE FAUCET

Figure 44—Gasoline Tank Controls

RA PD 333020

OPERATION OF AUXILIARY EQUIPMENT

b. Tank Controls (fig. 44).

(1) **SELECTIVE OPERATOR VALVE CONTROL.** Selective operator valve controls are mounted in the right rear equipment chest and are interconnected with emergency valves on bottom side of each tank. Control levers are pulled forward when in discharge position. Levers will automatically be released to off position when door of cabinet is closed.

(2) **FRONT END TRIP RELEASE.** The front end trip release control handle is mounted at left front of body and is accessible to driver. When this trip release handle is pulled out, discharge of each tank is instantly sealed.

(3) **DISCHARGE FAUCET.** Faucet mounted at rear of body is equipped with a dust cap and locking hasp. Faucet is key operated. Spring loaded shut-off valve will hold shut when key is withdrawn.

(4) **MANHOLE COVER.** Manhole in each tank is equipped with a sealed, hinged type cover provided with latch which can be pad-locked when in closed position. Each cover is provided with a vent, together with a fuse plug, which will provide additional vent in case of fire.

(5) **SAFETY CHAIN.** Each body is equipped with a safety chain of sufficient length to drag on the ground to prevent accumulation of static electricity.

(6) **EQUIPMENT COMPARTMENTS.** Equipment compartments on each rear side of body are furnished with door which hinges at top. Right compartment contains the selective controls, as well as space for additional equipment. Left compartment contains gage, gasoline cans and other equipment.

28. TANK BODY CAMOUFLAGE EQUIPMENT.

a. Some of the water tank and gasoline tank bodies are provided with camouflage equipment. This equipment consists of regulation cargo body bows, top tarpaulin, and rear curtain. These parts are installed in same manner as on the cargo bodies. After installation, the tank bodies have the appearance of regulation cargo bodies.

Section VII

OPERATION UNDER UNUSUAL CONDITIONS

29. COLD WEATHER OPERATION.

a. **General.** The operation and maintenance of these vehicles at low temperatures involve factors which do not exist at moderate temperatures. Since subzero temperatures affect both metals and lubricants, operation of the vehicles at these temperatures presents problems that demand special precautions.

TRUCK, 2½-TON, 6 x 6

b. **Gasoline.** Winter grade of gasoline is designed to reduce cold weather difficulties; therefore, the winter grade of motor fuels procured under U.S. Army Specification 2-103, grade C, latest revision, will be used in gasoline engines of all vehicles. For vehicles within the continental limits of the United States, the winter grade of gasoline meeting U. S. Army Specification 2-114, grade C, will be used.

(1) **STORAGE.** Due to condensation of moisture from the air, water will accumulate in tanks, drums, and containers. At low temperatures, this water will form ice crystals that will clog fuel lines and carbureter jets unless the following precautions are taken.

(a) Strain the fuel through filter paper or any other type of strainer that will prevent the passage of water. **CAUTION:** *Gasoline flowing over a surface generates static electricity that will result in a spark unless means are provided to ground the electricity. A metallic contact between the container and the tank will be provided to insure an effective ground.*

(b) Keep tank full if possible. The more fuel there is in the tank, the smaller will be the volume of air from which moisture can be condensed.

(c) Add one quart of denatured alcohol, grade 3, to the fuel tank at start of winter season, and one pint per month thereafter. This will reduce the hazard of ice formation in the fuel.

(d) Be sure that all containers are thoroughly clean and free from rust before storing fuel in them. If possible, after filling or moving a container, allow the fuel to settle 24 hours before filling vehicle tank from it. Keep all closures of containers tight to prevent snow, ice, dirt, and other foreign matter from entering.

(e) Wipe all snow or ice from dispensing equipment and from around fuel tank filler cap before removing cap to refuel vehicles.

c. **Care of Engine When Not Running.** For long periods of shut-down, as in bivouac, park vehicle in as sheltered a place as possible. For short shut-down periods, the vehicle should be parked in a sheltered spot out of the wind if possible. If no shelter is avail-

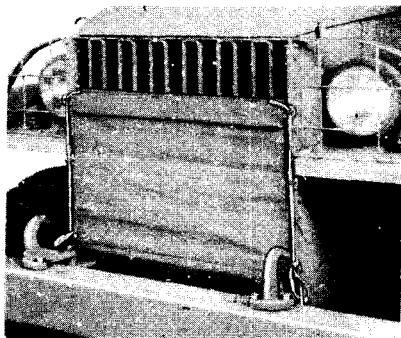

BOTTOM

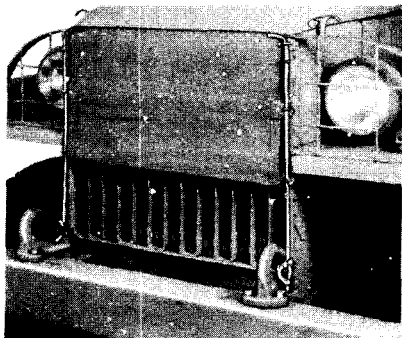

TOP

Figure 45—Positions of Radiator Shroud

RA PD 332916

OPERATION UNDER UNUSUAL CONDITIONS

able, it will be helpful to park so that the vehicle does not face into the wind. For a shut-down period up to three hours, it will be unnecessary to use shrouds and heaters.

(1) **OPERATION OF RADIATOR SHROUD.** Purpose of radiator shroud is to protect engine compartment from weather when vehicle is not operating, to warm engine quickly, and to keep engine and battery temperatures normal while operating in low temperatures. During engine operation, the driver should note temperature gage and if temperature drops below normal, shroud should be adjusted accordingly. Shroud can be adjusted either from top or bottom as shown in figure 45, and tied in position with rawhide straps which are furnished with shroud.

d. **Starting Instructions.** Pull choke out three-quarters to full. Do not manipulate choke until engine is running, and then with caution. Prime engine as required. Disengage clutch and operate cranking motor. Continue priming as required until engine starts and carbureter cuts in. After engine has started, it must be allowed to idle until cooling system temperature begins to rise. Check battery warming coil for leaks (if vehicle is equipped with built-in heater). Regulate engine temperature by use of shutters on radiators.

30. COLD WEATHER LUBRICATION.

a. Transmission, Transfer Case, and Differentials.

(1) SAE 80 universal gear lubricant, where prescribed, is suitable for use at temperatures as low as -20° F. If consistent temperature below 0° F is anticipated, drain the gear cases while warm and refill with grade 75 universal gear lubricant which is suitable for operation at all temperatures below $+32^{\circ}$ F. If grade 75 universal gear lubricant is not available, SAE 80 universal gear lubricant, diluted with the fuel used in the engine in the proportion of one part fuel to six parts SAE 80 universal gear lubricant, shall be used. Make-up oil will be diluted in the same proportion before it is added to gear cases.

(2) After engine has been warmed up, engage clutch and maintain engine speed at fast idle for five minutes until gears can be engaged. Shift transmission into low (first) gear, and drive vehicle for 100 yards, being careful not to stall engine. This will heat gear lubricants to the point where normal operation can be expected.

b. Other Lubrication Points.

(1) **REAR SPRING SEAT BEARINGS.** If vehicle has been operated at least 1,000 miles, using No. 0 general purpose grease for lubrication, no special precautions are necessary for the rear spring seat (bogie) bearings. If quantities of No. 1 general purpose grease are in these bearings, it will be necessary to disassemble and wash in dry-cleaning solvent, dry, and then relubricate with No. 0 general purpose grease for satisfactory operation.

(2) **WHEEL BEARINGS.** Wheel bearings and grease cups using No. 2 general purpose grease shall be lubricated with the same lubricant at all times. If repacking must be performed at sufficiently low temperature that thorough hand-packing cannot be accomplished,

TRUCK, 2½-TON, 6 x 6

No. 0 general purpose grease may be used until temperature returns to above 0° F.

(3) **CHASSIS POINTS.** Other chassis points must be lubricated with No. 0 general purpose grease.

(4) **HYDROVAC CYLINDERS.** Lubricate with shock absorber fluid, light, at all temperatures.

(5) **STEERING GEAR HOUSING.** Drain, if possible, or use suction gun to remove as much lubricant as possible. Refill with grade 75 universal gear lubricant, or, if not available, with SAE 80 universal gear lubricant diluted with fuel used in the engine in the proportion of one part fuel to six parts SAE 80 universal gear lubricant. Make-up oil will be diluted in the same proportion before it is added to the housing.

(6) **OILCAN POINTS.** For oilcan points where engine oil is prescribed for above 0° F, use light preservative lubricating oil.

c. Preparation of Engines Not Equipped with Cold Weather Kits.

(1) **KEEPING CRANKCASE OIL FLUID.** Several methods for keeping crankcase oil sufficiently fluid for proper lubrication are listed below. Preference should be given to the different methods in the order listed, according to the facilities available.

(a) Keep the vehicle in a heated enclosure when it is not being operated.

(b) When the engine is stopped, drain the crankcase oil while it is still hot and store in a warm place until the vehicle is to be operated again. If warm storage is not available, heat the oil before re-installing. **NOTE:** *Do not get the oil too hot; heat only to the point where the bare hand can be inserted without burning. Tag the vehicle in a conspicuous place in the cab to warn personnel that the crankcase is empty.*

(c) Dilute the crankcase oil. Crankcase oils may be diluted with gasoline or Diesel fuel according to their availability, with preference given to gasoline. One of the two following procedures will be used to provide the engine with properly diluted engine oil for cold starting.

(2) WHEN GASOLINE IS AVAILABLE FOR DILUENT.

(a) Fill engine crankcase to the "FULL" mark with the grade of engine oil prescribed for use at temperatures from 32° F to 0° F. Add 1½ quarts of gasoline for each 5 quarts of crankcase oil capacity. **EXAMPLE:** Crankcase with capacity of 10 quarts will require 3 quarts of gasoline as an oil diluent.

(b) Run the engine 5 to 10 minutes to mix the lubricant and diluent thoroughly.

(c) Stop the engine and note that the level of the diluted oil is above the normal "FULL" mark on the oil gage. This level should be marked on the gage for future reference.

(d) The presence of a large percentage of light diluent will increase oil consumption and, for that reason, the oil level should be checked frequently. Use the grade of engine oil prescribed for use

OPERATION UNDER UNUSUAL CONDITIONS

between 32° F to 0° F to maintain the oil level to dip stick "FULL" mark during operation.

(e) If the vehicle is operated four hours or more at operating temperature, redilution will be necessary if it is anticipated that the vehicle will be left standing unprotected for five hours or more. This can be accomplished by adding engine oil prescribed for use between 32° F to 0° F to the dip stick "FULL" mark; then adding gasoline to the dilution mark on the gage described in step (c) above.

(3) If Diesel fuel is used as diluent, drain the crankcase while the engine is still warm and refill, using engine oil prescribed for temperatures between 32° F to 0° F diluted with grade X Diesel fuel oil in the proportion of 1½ quarts of Diesel fuel to five quarts of engine oil. The presence of a large percentage of diluent will increase oil consumption and, therefore, the oil level will be checked frequently during operation and maintained with the diluted oil to dip stick "FULL" mark.

(4) If the vehicle is to be kept outdoors, and if the crankcase cannot be drained, cover the engine with a tarpaulin. About three hours before the engine is to be started, place fire pots under the tarpaulin. A Vag Prag, Primus-type, or other type blowtorch and ordinary kerosene lanterns may be used. With due consideration for the fire hazard involved, the flame may be applied directly to the oil pan.

31. PROTECTION OF COOLING SYSTEM AND PREPARATION OF VEHICLE FOR COLD WEATHER OPERATION.

a. Protection of Cooling System.

(1) Cooling system will be protected with antifreeze compound for operation below +32° F. The following instructions apply to use of new antifreeze compound. For use of reclaimed antifreeze solutions, refer to Ordnance Field Service Technical Bulletin 700-20, dated 13 October 1942.

(2) Before adding antifreeze compound, it is necessary that the cooling system be clean and completely free from rust. If the cooling system has been cleaned recently, it may be necessary only to drain, refill with clean water, and again drain. Otherwise, the system will be cleaned with cleaning compound.

(3) Heaters, water cooled compressors, and other units in the cooling system must be cleaned in addition to the radiator and engine water jacket.

(4) All hoses must be inspected and replaced if deteriorated. Hose clamps, plugs, and petcocks must be inspected and tightened if necessary. Radiator leaks must be repaired before adding antifreeze compound. Exhaust gas or air leakage into the cooling system must be corrected.

(5) When the cooling system is clean and tight, add antifreeze compound, using the proportion of antifreeze compound to the cooling system capacity indicated below. The system should be protected to at least 10° F below the lowest expected temperature to be experienced during the winter season.

TRUCK, 2½-TON, 6 x 6

| Atmospheric Temperature Degrees Fahr. | Quantity of Ethylene Glycol (Qt) | Quantity of Water (Qt) |
|---|--|---------------------------|
| +20 | 3¼ | 15¾ |
| +10 | 4¾ | 14¼ |
| 0 | 6½ | 12½ |
| - 5 | 7 | 12 |
| -10 | 7½ | 11½ |
| -15 | 8 | 11 |
| -20 | 8½ | 10½ |
| -30 | 9¼ | 9¾ |
| -40 | 10 | 9 |
| -50 | 10¾ | 8¼ |
| -60 | 11½ | 7½ |

(6) After adding antifreeze compound, fill with water to slightly below the filler neck; then start and warm the engine to normal operating temperature.

(7) The engine should then be stopped and the solution checked with a hydrometer, adding antifreeze compound if required.

(8) In service, the coolant is to be inspected weekly for strength and color. Rusty solution should be drained, the cooling system thoroughly cleaned, and new solution of the required strength added.

(9) CAUTIONS:

(a) Antifreeze compound is the only antifreeze authorized for Ordnance material.

(b) It is essential that antifreeze solutions be kept clean. Use only containers and water that are free from dirt, rust, and oil.

(c) Use an accurate hydrometer. To test a hydrometer, use one part antifreeze compound to two parts water. This solution should produce a hydrometer reading of 0° F.

(d) Do not spill antifreeze compound on painted surfaces.

b. Electrical Systems.

(1) GENERATOR AND CRANKING MOTOR. Check the brushes commutators, and bearings. See that the commutators are clean. The large surges of current which occur when starting a cold engine require good contact between brushes and commutators.

(2) WIRING. Check, clean, and tighten all connections, especially the battery terminal. Care should be taken that no short circuits are present.

(3) COIL. Check coil for proper functioning.

(4) DISTRIBUTOR. Clean thoroughly, and clean or replace points. Check the points frequently. In cold weather, slightly pitted points may prevent engine from starting.

(5) SPARK PLUGS. Clean and adjust or replace if necessary. If it is difficult to make the engine fire, reduce the gap 0.005 inch less than normally used (par. 89). This will make ignition effective at the reduced voltages likely to prevail.

(6) TIMING. Check carefully. Care should be taken that the spark is not unduly advanced or retarded.

(7) BATTERIES.

OPERATION UNDER UNUSUAL CONDITIONS

(a) The efficiency of batteries decreases sharply with decreasing temperatures, and becomes practically nil at -40° F. Do not try to start the engine with the battery when it has been chilled to temperature below -30° F until battery has been heated, unless a warm slave battery is available. See that the battery is always fully charged, with the hydrometer reading between 1.275 and 1.300. A fully charged battery will not freeze at temperatures likely to be encountered even in arctic climates, but a fully discharged battery will freeze and rupture at $+5^{\circ}$ F.

| Specific Gravity Taken at 60 Degrees Fahr. | Freezing Temperature Degrees Fahr. |
|--|---------------------------------------|
| 1.100 | +18 |
| 1.120 | +14 |
| 1.140 | + 8 |
| 1.160 | + 2 |
| 1.180 | - 6 |
| 1.200 | -17 |
| 1.220 | -31 |
| 1.240 | -51 |
| 1.260 | -75 |
| 1.280 | -92 |
| 1.300 | -95 |

(b) Do not add water to a battery when it has been exposed to subzero temperatures unless the battery is to be charged immediately. If water is added and the battery not put on charge, the layer of water will stay at the top and freeze before it has a chance to mix with the acid.

(c) *Testing Specific Gravity.* Determination of specific gravity is accomplished by the use of a commercial hydrometer supplied for this purpose. These are usually calibrated to read accurately only when electrolyte is at certain specified temperature. Standards commonly used are 60° and 80° F. It is necessary to make corrections when taking readings at temperatures other than specified standard of hydrometer used. For every 10° the temperature is above the hydrometer standard, 0.004 must be added to the specified gravity reading. For every 10° the temperature is below the standard, 0.004 must be subtracted from the reading. Specific gravity readings without corrections for temperature are meaningless.

(8) **LIGHTS.** Inspect the lights carefully. Check for short circuits and presence of moisture around sockets.

(9) Before every start, see that the spark plugs, wiring, or other electrical equipment is free from ice.

c. Engines.

(1) Be sure that no heavy grease or dirt has been left on the cranking motor throwout mechanism. Heavy grease or dirt may keep the gears from being meshed or cause them to remain in mesh after the engine starts running. The latter will ruin the cranking motor and necessitate repairs.

TRUCK, 2½-TON, 6 x 6

(2) A full choke is necessary to secure the rich air-fuel mixture required for cold weather starting. Check the butterfly valve to see that it closes all the way, and otherwise functions properly.

(3) Carbureters which give no appreciable trouble at normal temperatures may not operate satisfactorily at low temperatures. A fuel pump which will deliver enough gasoline at normal starting speeds of 500 revolutions per minute may have leaky valves or a defective diaphragm which will prevent it from delivering the amount of fuel required to start the engine at low temperatures when turning speeds are reduced to 30 to 60 revolutions per minute. Faulty fuel pumps or carbureters should be corrected or replaced.

(4) **AIR CLEANERS.** At temperatures between 0°F and -40°F, remove air cleaner, disassemble, wash all parts in dry-cleaning solvent, dry thoroughly, and reassemble. Refill to correct level with **OIL**, hydraulic or **FLUID**, shock absorber, light. Check reservoir daily and fill to correct level if necessary. Every 1,000 miles, disassemble, wash, dry, reassemble, and refill with above oil. This applies also to crankcase breather air cleaner. Below -40° F, carbureter and crankcase air cleaner must be disassembled, washed, reassembled, and replaced dry.

d. Fuel System. Remove and clean strainer daily. Also drain fuel tank sump daily to remove water and dirt.

e. Chassis.

(1) Brake bands, particularly on new vehicles, have a tendency to bind when they are very cold. Always have a blowtorch handy to warm up these parts if they bind when attempting to move the vehicle. Parking the vehicle with the brake released will eliminate most of the binding. Precaution must be taken, under these circumstances, to block the wheels or otherwise prevent movement of the vehicle.

(2) Inspect the vehicle frequently. Shock resistance of metals, or resistance against breaking, is greatly reduced at extremely low temperatures. Operation of vehicles on hard, frozen ground causes strain and jolting which will result in screws breaking or nuts jarring loose. Cables should operate satisfactorily at all temperatures providing they are coated with No. 0 general purpose grease and there is no excess grease in the housing.

32. HOT WEATHER OPERATION.

a. Operation of these vehicles in high temperatures requires regular maintenance of cooling units, lubrication filtering devices, and air cleaners. In extremely high temperatures, water saving devices such as surge or overflow tanks should be employed.

b. Cooling System Maintenance.

(1) **COOLING LIQUID.** Formation of scale and rust in cooling system occurs more often during operation in extremely high temperatures; therefore, rust preventives should always be added to the cooling liquids (par. 107). Use only clean water. Avoid the use of water that contains alkali or other substances which may cause scale and rust formation.

OPERATION UNDER UNUSUAL CONDITIONS

(2) **CLEANING COOLING SYSTEM.** Cooling system should be thoroughly cleaned and flushed at frequent intervals when operating in extremely high temperatures.

(3) **FAN BELT AND WATER PUMP.** Fan belt should be inspected at regular intervals and adjusted if necessary (par. 108). Water pump must be kept in good operating condition.

(4) **THERMOSTAT.** Check operation of thermostat (par. 110). Thermostat must open at calibrated temperature to prevent overheating of cooling liquid.

(5) **HOSE CONNECTIONS.** Check connections frequently for leaks.

c. **Oil Filters.** Oil filter elements must be checked and replaced at more frequent intervals if vehicle is operating in hot, sandy regions. Crankcase air vent cleaner must be serviced at frequent intervals.

d. **Air Cleaners.** If vehicle is operating extensively in sandy or dusty regions, carburetor air cleaner should be cleaned daily. If vehicle operates in dust storm areas, cleaner should be cleaned immediately after such storms occur.

e. Battery.

(1) **WATER LEVEL.** In torrid zones, cell water level should be checked daily and replenished if necessary with pure distilled water. If this is not available, any water fit to drink may be used. However, continuous use of water with high mineral content will eventually cause damage to battery and should be avoided.

(2) **SPECIFIC GRAVITY.** Batteries operating in torrid climates should have a weaker electrolyte than for temperate climates. Instead of 1.300 gravity, the electrolyte should be adjusted to around 1.210 to 1.230 for a fully charged battery. This will prolong the life of the negative plates and separators. Under this condition, battery should be recharged at about 1.160. Where freezing conditions do not prevail, there is no danger with gravities from 1.230 to 1.075.

(3) **SELF-DISCHARGE.** A battery will "self-discharge" at a greater rate at high temperatures if standing for long periods. This must be taken into consideration when operating in torrid zones. If necessary to park for several days, battery should be removed and stored in a cool place.

f. **Operating Vehicle.** In extremely high temperatures, avoid the continuous use of low gear ratios whenever possible. Frequent inspection and servicing of air cleaners, fuel filter, and oil filter should be made during operation in dusty areas. Watch the temperature and oil gages constantly. Check and replenish oil and water frequently.

g. **Side Panels.** *Engine side panels must not be removed to lower cab temperature or for any other reason.* The engine hood side panels form an air tunnel which directs air onto and past engine for best cooling effect. After hood side panels are removed, effectiveness of the air tunnel is lowered, and the air drawn through radiator by the fan, blows out of engine compartment without being directed

TRUCK, 2½-TON, 6 x 6

over entire engine. The cooling efficiency is thus decreased and engine temperature raised. Hood side panels must not be removed except for access to engine for servicing or repairs.

h. Manifold Heat Control. At temperatures above 60°F, place manifold heat control into "OFF" position.

33. OPERATION ON STEEP GRADES.

a. Going Up Grades. When ascending steep grades, always shift into lower transmission speeds before vehicle begins to labor. This can be accomplished most successfully when vehicle still has sufficient momentum to permit changing gears without bringing vehicle to a stop.

(1) **CAUTION:** When shifting to a lower gear at any rate of vehicle speed, make sure that engine speed is "synchronized" with vehicle speed before clutch is engaged. If clutch is engaged when engine is operating at lower than relative vehicle speed, the drive line may be damaged.

b. Going Down Grades. The importance of restraining speed of vehicle and speed of engine while descending grades cannot be over-emphasized. Refer to the maximum permissible road speed plate. The plate clearly states maximum speed at which truck may be safely operated in various gear ratios of transmission and ranges of transfer case. In general, it is advisable to use the same transmission speed going down hill as would be required to climb the same hill. Hold the vehicle speed not to exceed maximum shown on plate. Instructions as follows should be observed when descending grades.

(1) Keep vehicle under control at all times.

(2) It is desirable to reduce speed of vehicle with the brakes several times during the descent of a hill.

(3) Remember that possibility of overspeeding is greater when truck is loaded, therefore more caution is required.

(4) Do not use a lower gear ratio than would be required to ascend the same hill.

(5) Do not allow the vehicle to exceed the maximum permissible speed for the particular gear ratio selected.

(6) Disengage front axle before using the transmission as a brake when going down a steep hill, especially before shifting to a lower gear.

34. OPERATION ON SAND OR SOFT TERRAIN.

a. Mud. Always use tire chains and use all driving axles at ratio low enough to steadily pull vehicle out. Do not try the impossible. If stuck, winch out if vehicle is equipped with winch, or wait until assistance arrives.

b. Sand. Operation in sand requires a technique different than that used when operating in mud. The track must be "laid," not dug. Do not permit wheels to spin. If motor labors, depress clutch

OPERATION UNDER UNUSUAL CONDITIONS

pedal immediately. Reverse and then go forward again. It may be necessary to repeat this procedure several times. If stuck in the sand, winch out. Constant spinning of the wheels will only dig in deeper.

35. PREVENTION OF DAMAGE BY SUBMERSION.

a. **General.** If vehicle is driven through deep water for any appreciable length of time or completely submerged in water, precautions must be taken to avoid serious damage to the engine, clutch, transmission, transfer case, axles, universal joints, winch, steering gear, battery, fuel tank, brakes, and wheel bearings.

b. If vehicle is not completely submerged but operates in fairly deep water for any length of time, particular attention must be given to the wheel bearings, brake mechanism, and axle differentials.

(1) **WHEEL BEARINGS.** Remove all wheel bearings and clean and repack with lubricant (par. 200).

(2) **BRAKE MECHANISM.** Brake mechanism should be thoroughly examined after submersion in water and all parts cleaned and lining replaced if necessary.

(3) **DIFFERENTIALS.** If axle differentials have been operated under water for any length of time, drain and flush differentials and refill with correct lubricant.

c. If vehicle operates in deep water which may partially submerge engine, particular attention must be given to units which have been submerged, such as brake, master cylinder, cranking motor, battery, distributor, transmission, transfer case, and winch. If clutch has been submerged, it is necessary that it be completely disassembled and cleaned thoroughly. Do not attempt to flush it.

(1) **MASTER CYLINDER.** Drain and flush brake system completely with alcohol, then refill with fresh brake fluid.

(2) **ELECTRICAL.** If cranking motor, generator, or distributor have been submerged, remove the units, clean thoroughly, wipe dry, and reinstall if tests prove that the units are functioning. If battery is submerged, check the electrolyte solution. If solution is dirty, or abnormally high, replace the battery. Check the specific gravity and if necessary, recharge or replace.

(3) **TRANSMISSION, ETC.** Drain lubricant, flush, and refill.

d. If vehicle has been completely submerged, each unit which has been submerged must be completely dismantled, cleaned, and lubricated. If it is known that water or dirt has entered engine, the crankcase should be drained, and engine thoroughly flushed. If engine has been submerged for any length of time, engine should be completely overhauled.

e. If vehicle is subjected to salt water, or operates near salt water, keep all exposed metal surfaces painted or thoroughly oiled. Precautions must be taken to seal the regulator and other electrical switch devices to prevent excessive corrosion. Salt water or salt air will attack all metals and will eventually corrode such parts, preventing operation.

PART THREE—MAINTENANCE INSTRUCTIONS

Section VIII

LUBRICATION

36. LUBRICATION ORDER.

a. War Department Lubrication Order No. 504 (figs. 46 and 47) prescribes lubrication maintenance for truck, 2½-ton, 6 x 6 GMC CCKW-352 and 353.

b. A Lubrication Order is placed on or is issued with each vehicle and is to be carried with it at all times. In the event the vehicle is received without an Order the using arm shall immediately requisition a replacement from the Commanding Officer, Fort Wayne Ordnance Depot, Detroit 32, Michigan.

c. Lubrication instructions on the Order are binding on all echelons of maintenance and there shall be no deviations from these instructions.

d. Service intervals specified on the Order are for normal operating conditions. Reduce these intervals under extreme conditions such as excessively high or low temperatures, prolonged periods of high speed, continued operation in sand or dust, immersion in water, or exposure to moisture, any one of which may quickly destroy the protective qualities of the lubricant and require servicing in order to prevent malfunctioning or damage to the materiel.

e. Lubricants are prescribed in the "Key" in accordance with three temperature ranges: above +32°F, +32°F to 0°F and be-

LUBRICATION

cant until the old lubricant is forced from the vent. Exceptions are specified in notes or on the Lubrication Order. Always wipe clean metal surfaces on which a film of lubricant must be maintained by manual application, before the film is renewed.

b. Points of Application.

(1) Lubrication fittings, grease cups, oilers, and oil holes are readily located by reference to the Lubrication Order. Wipe clean such lubricators and the surrounding surface before lubricant is applied.

(2) Where relief valves are provided, apply new lubricant until the old lubricant is forced from the vent.

c. Cleaning. Use dry-cleaning solvent, or Diesel fuel oil, to clean or wash all parts. Use of gasoline for this purpose is prohibited. After washing, dry all parts thoroughly before applying lubricant.

d. Lubrication Notes on Individual Units and Parts. The following instructions supplement and repeat for clarity those notes on Lubrication Order which pertain to lubrication and service of individual units and parts.

(1) **AIR CLEANERS (OIL BATH TYPE).** Daily, check level and if necessary fill to level mark. Every 1,000 miles remove element and reservoir and wash all parts. Refill reservoir to level mark with used crankcase oil or (OE) engine oil, seasonal grade; except clamp mounted carbureter air cleaner which uses SAE 50 above +32° F or SAE 30 between +32° F and 0° F. From 0° F to -40° F, use (SA) shock absorber fluid, light. Below -40° F, wash and operate dry. (Element or mesh type)—Every 1,000 miles, remove element, wash, dry and reoil with used crankcase oil or (OE) engine oil, seasonal grade. From 0° F to -40° F, use (SA) shock absorber fluid, light. Below -40° F, remove oil and operate dry. (Governor air cleaner)—Every 6,000 miles remove governor air cleaner screen and felt (par. 96). Clean, dry and reoil felt with a few drops of (OE) engine oil, SAE 10. Reinstall felt and screen (par. 96).

(2) **BREATHERS OR VENTS.** Weekly clean dirt from breathers or vents at transfer case and axle differentials. Every 6,000 miles remove breathers and clean in dry-cleaning solvent.

(3) **CRANKCASE.** Daily, check level and refill to "FULL" mark with (OE) engine oil, SAE 30 above +32° F, or SAE 10 from +32° to 0° F. Below 0° F, refer to OFSB 6-11. Every 1,000 miles, remove drain plug from bottom of oil pan and completely drain case. Drain only when engine is hot. After thoroughly draining, replace drain plug and refill crankcase to "FULL" mark on gage with correct lubricant to meet temperature requirements. Run engine a few minutes, recheck level, and add oil if required. Be sure pressure gage indicates oil is circulating. Two piece oil pan has screen attached to drain plug. When drain plug is removed, clean plug and screen before replacing. Oil pan capacity, under various conditions is as follows:

| Oil Capacity | Filter | Element |
|--------------|-------------|-------------|
| 7½ qt | Not drained | Not removed |
| 9 qt | Drained | Not removed |
| 10 qt | Drained | Removed |

TRUCK, 2 1/2-TON, 6 x 6

WAR DEPARTMENT
ORDNANCE DEPARTMENT
LUBRICATION ORDER
No. 504

TRUCK, 2 1/2-TON, 6x6
(GMC MODELS CCKW-352 AND CCKW-353)

SNL G-508.

For detailed instructions, refer to TM 9-801.

Serviced From Under Hood

- 1 OE Generator & 8 drops
- 6 OE Carburetor Air Cleaner
- 7-8 OE Governor Air Cleaner
- 15-16 6 Front Axle Differential Drains
- 15-16 W GO Front Axle Diff. Fill and Level
- 3 I Oil Filter Drain sediment
- 1 Every 6,000 miles, clean case, remove element
- 9 OE Crankcase Fill
- 4 OE Crankcase Ventilator Air Cleaner Check level (See Note)
- 4 I WB Distributor Shaft
- 1 Distributor (See Note)
- 32 I CG Universal Joint (Underneath truck)
- 2 I Crankcase Drains
- 5 OE Starter & 8 drops
- 5 OE Starter Outboard Bearing
- 9 D OE Hydrovac Air Cleaner

NOTE— See Reverse Side for lubrication of PUMP BODIES.

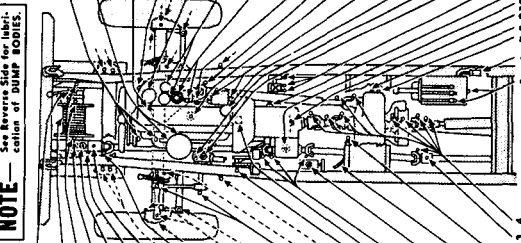

- 53 Lubricant • Interval OE W Winch Jaw Clutch
- 52 Clean and oil sparingly OE W Winch Cable (See Note)
- 50-51 CG I Winch Drum and Shaft Brgs.
- 49 Winch Worm Housing Drain 6
- 49 Winch Worm Housing Fill GO
- 49 Winch Worm Housing Level W
- 54 Propeller Shaft Shear Pin OE I (See Note)
- 47 Spring Shackles CG I
- 33 Universal Joint CG I
- 45-46 Front Wheel Bearings WB 6 (Remove, clean and inspect)
- 25-26-27 Universal Joint and Steering Knuckle Bearings (See Note) CG I
- 42 Tie Rod CG I
- 30 Dreg Link CG I
- 48 Shock Absorber SA 6
- 39-40 Spring Bolt CG I
- 19 to 24 Pedal Shaft (Some models) WB
- 33-34 Clutch Pilot Bearing (See Note) CG I
- 28 Universal and Slip Joints (See Note) HB I
- Brake Master Cylinder fill to 1/2 in. from top

LUBRICATION

RA PD 333058B

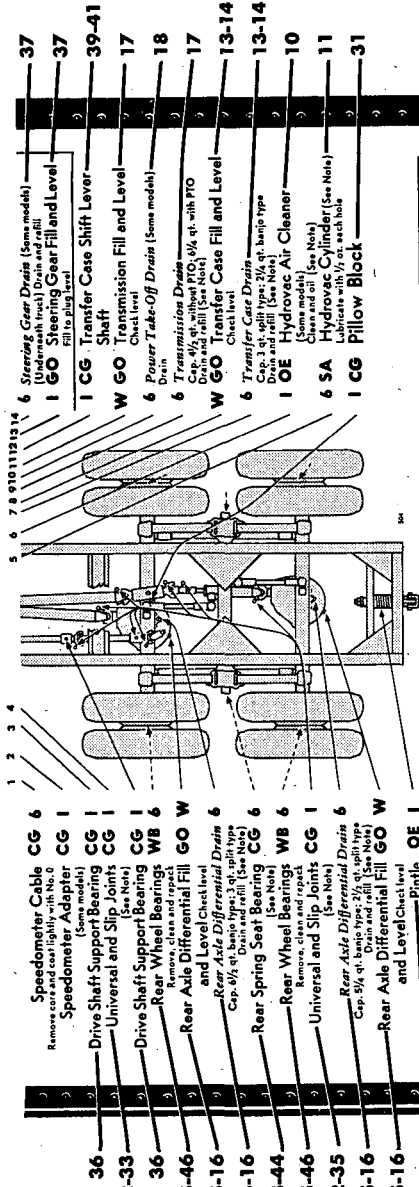

- 36 Speedometer Cable CG 6
Remove core and coat lightly with No. 0 Grease
- 36 Speedometer Adapter CG 1
- 32-33 Drive Shaft Support Bearing CG 1
- 32-33 Universal and Slip Joints CG 1 (See Note)
- 36 Drive Shaft Support Bearing CG 1
- 36 Rear Wheel Bearings WB 6
- 45-46 Remove, clean and repack bearings
- 15-16 Rear Axle Differential Fill GO W
- 15-16 and Level Check level
- 15-16 Rear Axle Differential Drain CG 6
Cap. 9/16 qt. (See Note)
- 43-44 Rear Spring Seat Bearing CG 6 (See Note)
- 45-46 Remove, clean and repack bearings
- 32-35 Rear Axle Differential Drain CG 6
Cap. 3/4 qt. (See Note)
- 15-16 Rear Axle Differential Fill GO W
- 15-16 and Level Check level
- 38 Pintle OE 1
- 37 Steering Gear Drain (Some models) (Underneath truck) Drain and refill
- 37 Steering Gear Fill and Level Fill to plug level
- 39-41 Transfer Case Shift Lever Shaft
- 17 Transmission Fill and Level Check level
- 18 Power Take-Off Drains (Some models) Drain and refill (See Note)
- 17 Transmission Drain Cap. 9/16 qt. without PTO; 5/8 qt. with PTO Drain and refill (See Note)
- 13-14 Transfer Case Fill and Level Check level
- 13-14 Transfer Case Drain (Some models) Drain and refill (See Note)
- 10 Hydrovac Air Cleaner (Some models) Clean and oil (See Note)
- 11 Hydrovac Cylinders (See Note) Lubricate with 1/2 qt. each hole
- 31 CG Pillow Block

NOTES
Clean before lubricating. Lubricate bearings.
CLEANING: Clean parts with SOLVENT, kerosene or Oil, fuel, Diesel. Dry before lubricating.

NOTES
Requisition replacement Lubrication Orders from the Commanding Officer, or the Ordnance Depot, Detroit 32, Michigan.

NOTES
INTERVALS—Reduce under severe operating conditions.
ARROWS—Lubricate dotted arrow points on both sides. Opposite points are shown by short arrows.
(Notes continued on Reverse Side)

KEY

| LUBRICANTS | LOWEST ANTICIPATED AIR TEMPERATURE | ALL TEMPERATURES | INTERVALS |
|-------------------------------|------------------------------------|--|---------------|
| OE—Oil, engine Grease | above +32°F. to 0°F. SAE 10 | WB—GREASE, general purpose, No. 2 | D—Daily |
| Other Points | SAE 30 | HB—FLUID, hydraulic brake | W—Weekly |
| GO—LUBRICANT, gear, universal | SAE 90 | SA—FLUID, shock-absorber, light universal | I—1,000 miles |
| CG—GREASE, general purpose | No. 1 | PS OIL, lubricating, preservative, special | 6—6,000 miles |

No. 504 (NOT TO BE REPRODUCED IN WHOLE OR IN PART WITH-
OUT PERMISSION OF THE OFFICE OF THE CHIEF OF DEFENSE) CHECK-CHART

25, Mar 44
Supersedes all previous editions.

Figure 46—Lubrication Order (Chassis)

WAR DEPARTMENT  **LUBRICATION ORDER**
ORDNANCE DEPARTMENT

No. 504



TRUCK, 2 1/2-TON, 6x6
(GMC MODELS CCKW-352 AND CCKW-353) (DUMP BODIES)

For detailed instructions, refer to TM 9-801.



SNL G-504

CAUTION

Always place a prop or block under body before performing any service work.

For detailed instructions, refer to TM 9-801.

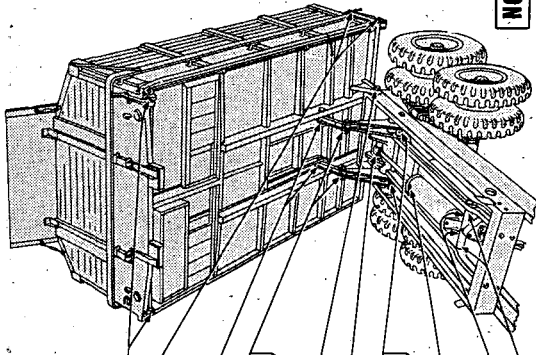

- Lubricant's Interval
- Control Rod Linkage Joints OE 2W
 - Body Side and End Gate Cross Shafts and Rods OE 2W
(Also lubricate points on opposite side)
 - Link Pins (Some Nail Models) CG 2W
 - Link Pins (Some Nail Models) CG 2W
 - Trunnion Shaft Bearings CG 2W
(See Wood Models)
 - Body Hinge Pin CG 2W
(Also lubricate point on opposite side)
 - Hoist Wrist Pin CG 2W
 - Lifting Lever (Nail Models) CG 2W
 - Hoist Arm Links (See Wood Models) CG 2W
 - Hydraulic Cylinder Fill and Level OE 2W
Cap. 1 qt. Nail; 12 qt. See Wood Use SAE 10 below 72°F; (See Note)
 - Hoist Trunnion Pin (Some Nail Models) CG 2W
 - Cylinder Hinge (See Wood Models) CG 2W

NOTE— See Reverse Side for Lubrication of TRUCK.

TRUCK, 2 1/2-TON, 6 x 6

RA PD 333059B

NOTES

While in this position remove filler and vent plug and fill with OE. After filling, the vibrator is full, raise the body to maximum elevation, then add approximately 1/2 pt. of OE. Do not replace vent plug. Body oil through the vent plug. Replace vent plug with body oil at maximum height. Every 6 months, drain through plug under pump assembly. Every 1,000 miles, remove filler plug and fill with OE to overflowing. Initial plug slowly raise fill to lower body. Replace plug. Every 6 months, drain by removing plate under pump and refill. **HYDRAVIC CYLINDER**—Some models on left side of frame to rear of transfer case. Every 1,000 miles, remove plug in rear end of cylinder and lubricate with OE. Also lubricate vacuum cylinder, leave bearing, located on frame ahead of cylinder, through fitting, with CG. **REAR SHOCK**—Remove pin, clean, dry and coat with lubricate with CG until all old grease is forced out of bearing. Replace pin and reassemble. **UNIVERSAL AND SLIP JOINTS (Winch and Hoist)**—Vents are not provided. Apply lubricant support bearings until lubricant appears between bearing and shaft. **UNIVERSAL JOINTS AND STEERING KNUCKLE BEARINGS**—Remove pin, clean, dry and coat with lubricant. **STEERING AXLE** is equipped with plug in hub driving flange. Remove plug at steering knuckle housing, lubricate first through fitting inserted in hub driving flange until lubricant is visible at plug hole. Replace plug. Lubricate split type axle, lubricate through fitting temporarily remove plug and lubricate through fitting temporarily

(Notes Continued from Reverse Side)
AIR CLEANER—(Oil Bath Type) Fill with OE except clump mounted carburetor air cleaner, refill with SAE 50 above 41-34 1/2. SAE 30 from 32-40. Below 40°F, remove oil and operate dry. Every 1,000 miles, remove and wash all parts. (Mesh Type) Every 1,000 miles, remove oil. Every 1,000 miles, remove and wash all parts. Below 40°F, wash and replace dry. (Breathes) Wreathly, remove dirt from main transfer plug from propeller shaft center bearing and differential vent. **CRANKCASE**—Drain only when engine is hot. Clean and refill with OE. **GEAR CASES**—Drain only after operation. Fill to plug level when hot, or to 1/2 inch below plug level when cold. Clean and refill with OE. Clean magnetic drain plugs on transfer case of models equipped with banjo type valves before replacing. If disassembled, refill on reassembly through fill plug hole with GO. **DISTRIBUTOR**—Every 1,000 miles, wipe the rotor and wick under rotor with 1 or 2 drops of OE. **OIL FILTER**—After sensing element, run engine a few minutes to fill with OE. **CLUTCH PILOT BEARING**—Whenever clutch or engine is removed, clean and repack clutch pilot bearing with grease. **CLUTCH PILOT BEARING**—Whenever clutch or engine is removed, clean and repack clutch pilot bearing with grease. Also fill clutch release bearing inside recess and coat fork groove, coat shaft splines, release fork socket and stud. **CAUTION:** Do not lubricate hydraulic cylinder. (Heat) To fill hydraulic cylinder, raise body to only 1/2 the maximum height.

KEY

| LUBRICANTS | LOWEST ANTICIPATED AIR TEMPERATURE | ALL TEMPERATURES | | INTERVALS |
|-------------------------------|------------------------------------|-----------------------------------|--|------------|
| | | WB—GREASE, general purpose, No. 2 | SA—FLUID, shock-absorber, light | |
| OE—Oil engine | above +32°F. to 0°F. | WB—GREASE, general purpose, No. 2 | SA—FLUID, shock-absorber, light | 2W—2 weeks |
| Greentase | SAE 30 | | | |
| Other Points | SAE 30 | PS | | |
| GO—LUBRICANT, gear, universal | SAE 90 | Grade 75 | | |
| CG—GREASE, general Purpose | No. 1 | No. 0 | PS—Oil lubricating preservative, special | |

No. 504 [NOT TO BE REPRODUCED in whole or in part without permission of the Chief of the District of Columbia] CHEL-CHART

25 Mar 44
Supersedes all previous issues.

Copy of this Lubrication Order will be supplied, with the necessary instructions for lubrication, to personnel in charge of maintenance.
By Order of the Secretary of War,
G. C. Marshall, Chief of Staff.

Figure 47—Lubrication Order (Hoist)

TRUCK, 2½-TON, 6 x 6

(4) **GEAR CASES.** Transmission, differentials, transfer case, and winch worm housing. Weekly, check level with truck on even ground, and if necessary, add lubricant to within ½ inch of plug level when cold, or to plug level when hot, except winch worm housing, which must be filled to plug level at all times. Fill front and rear banjo type axle differentials to level of lower plug hole. If removed, refill transfer case declutching unit, used with split type axle, when reinstalled, through plug hole with universal gear lubricant, SAE 90 above +32°F to 0°F, SAE 80° from +32° to 0°F, or Grade 75 below 0°F. Clean magnetic drain plug in transfer case of models equipped with banjo axles before replacing. (Power Take-off)—Vehicles equipped with a winch or hoist are also equipped with a power take-off, mounted at left side of transmission. Some of these power take-offs are fitted with a drain plug, which should be removed whenever transmission is drained. Some models do not have drain plug in power take-off and cannot be drained, except at transmission. No filler plug is provided in power take-off, as it is lubricated by the lubricant in the transmission.

(5) **DISTRIBUTOR.** Every 1,000 miles, lubricate distributor shaft by turning down cup one full turn, refill as required with (WB) general purpose grease No. 2. Every 6,000 miles wipe the distributor breaker cam lightly with (CG) general purpose grease, seasonal grade. Also lubricate the breaker arm pivot with one or two drops—and wick under rotor with one or two drops of (OE) engine oil, seasonal grade or (PS) preservative lubricating oil, special, below 0°F.

(6) **OIL FILTER.** Every 1,000 miles, when engine is drained remove drain plug from oil filter to drain oil and sediment in filter. Every 6,000 miles, remove filter element (par. 81). Clean inside of shell with clean rag and install new element (par. 81). Run engine a few minutes and check oil level. Add oil to bring crankcase oil level up to "FULL" mark on gage.

(7) **CLUTCH PILOT BEARING.** Whenever clutch or engine is removed, clean and repack clutch pilot bearing with (WB) general purpose grease, No. 2. After cleaning parts, fill cavity in crankshaft behind clutch pilot bearing. Also fill clutch release bearing inside recess and coat fork groove; coat shaft spline, release fork socket, and stud. **CAUTION:** *Do not wash clutch release bearing.*

(8) **HYDRAULIC CYLINDER.** Two types of hoist equipment (Heil and Gar Wood) have been used on these vehicles and require different filling and draining instructions. (*Heil*). Every two weeks, raise body to ½ its maximum height. Place safety block under body to prevent accidental dropping. Remove filler and vent plugs separately. With the pump control lever in the "RAISE" position, operate the pump slowly, while pouring (OE) engine oil, seasonal grade, through

LUBRICATION

filler plug opening until body is raised to its maximum height. Add about $\frac{1}{2}$ pint more oil, then lower body slowly, with pump running. Slowly raise and lower the body several times to expel all air and any excess oil. With body all the way up, install filler and vent plugs. Every 6 months raise body to its maximum height, and block in place to prevent accidental dropping. Remove plug at bottom of pump to drain oil from hydraulic cylinder. During draining, pump control lever should be in "LOWER" position. Install drain plug and perform filling operation. (Gar Wood). Every two weeks, raise body to its maximum height. Place safety block under body to prevent accidental dropping. Remove filler plug at side of cylinder. Fill to overflowing with (OE) engine oil, seasonal grade. Install plug tightly. Every 6 months raise body to its maximum height and block in place to prevent accidental dropping. Remove plate at bottom of pump to drain oil from hydraulic cylinder. During draining, pump control lever should be in "LOWER" position. Install plate and perform filling operation while pump is being operated, with control lever in "RAISE" position.

(9) HYDROVAC CYLINDER. Lubricate every 6,000 miles with (SA) shock absorber fluid, light. Remove pipe plug at center of rear shell, also plug from inside elbow at center plate. Apply $\frac{1}{2}$ oz of lubricant through each plug opening. Replace plugs. To insure proper spread of lubricant in cylinder, start engine and make 3 or 4 severe brake applications. Early vehicles are equipped with vacuum cylinder at left side of vehicle. Every 6,000 miles, remove plug in rear of cylinder and apply 1 oz (SA) shock absorber fluid through plug opening. Replace plug. Every 1,000 miles lubricate idler lever, ahead of vacuum cylinder, with (CG) general purpose grease, seasonal grade.

(10) REAR SPRING SEAT BEARINGS. Every 6,000 miles, remove bearing cap. Remove plug, insert fitting and lubricate with (CG) general purpose grease, seasonal grade, until all old grease is forced out of bearing. Replace plug and bearing cap. Some models are lubricated through fitting under spring seat.

(11) UNIVERSAL JOINTS AND SLIP JOINTS. (Truck)—Use (CG) general purpose grease, seasonal grade. Apply grease to universal joint until it overflows at the relief valve, and to the slip joint until lubricant is forced from the vent at the universal joint end of the spline. (Winch and Dump Hoist)—Universal and slip joints are not equipped with vents. Apply lubricant until it appears around journal and splines. Lubricate hoist support bearings until lubricant appears between bearing and shaft.

(12) UNIVERSAL JOINTS AND STEERING KNUCKLE BEARINGS. Every 1,000 miles lubricate with vehicle on level ground, with (CG) general purpose grease, seasonal grade. If split type axle is equipped

TRUCK, 2½-TON, 6 x 6

with plug in hub driving flange, remove plug at steering knuckle housing. Lubricate first through fitting in upper steering knuckle bearing, and then through fitting inserted in hub driving flange until lubricant is visible at plug hole. Replace plugs. To lubricate split type axle without plug in hub driving flange, remove plug and lubricate through fitting on upper steering knuckle until lubricant is visible at plug opening. On banjo type axles, where two plugs are provided, one on top of joint, the other one at front of steering knuckle support, use only plug in steering knuckle support and lubricate through fitting underneath joint until lubricant is visible at plug opening. Every 6,000 miles, remove universal joints, (par. 167). Wash and repack with (CG) general purpose grease, seasonal grade. Reinstall (par. 167).

(13) **WINCH DRIVE SHAFT SHEAR PIN.** Every 1,000 miles lubricate both ends of pin, also between yoke and worm shaft, with (OE) engine oil, seasonal grade. Every 6,000 miles, disconnect universal joint from winch worm shaft (par. 240). Clean shaft shear pin and inside of yoke. Coat inside of yoke and winch worm shaft with (CG) general purpose grease, seasonal grade. Install universal joint to worm shaft (par. 240).

(14) **WINCH CABLE.** After each use, clean and oil with used crankcase oil or (OE) engine oil, seasonal grade. Weekly, if cable has not been used, coat outer coils. Monthly, unwind entire cable, clean and oil.

(15) **WHEEL BEARINGS.** Every 6,000 miles remove bearing cone assemblies from hub (pars. 201 and 202). Wash bearings, cones, spindle, and inside of hub and dry thoroughly. Do not use compressed air. Inspect bearing races and replace if damaged. Wet the spindle and inside of hub with general purpose grease No. 2 to a maximum thickness of 1/16 inch only, to retard rust. Lubricate bearings with general purpose grease No. 2 with a packer, or by hand, kneading lubricant into all spaces in the bearing. Use extreme care to protect the bearings from dirt, and immediately reassemble and replace wheel. Do not fill hub. The lubricant in the bearing is sufficient to provide lubrication until the next service period. Any excess might result in leakage into the drum. Adjust bearings in accordance with instructions in paragraph 199.

(16) **PILLOW BLOCK.** Lubricate every 1,000 miles using (CG) general purpose grease, seasonal grade, until grease flows from breather at top of housing. When housing is equipped with a plug at side, remove and clean housing and bearings (par. 177). Reassemble and adjust bearings (par. 177). Replace pipe plug at side of housing with 90° fitting (par. 177).

(17) **STEERING GEAR.** Every 1,000 miles remove filler plug and check level of lubricant. Add (GO) universal gear lubricant, seasonal grade, until lubricant is to level of filler plug hole. Some models are equipped with a drain plug, which should be removed every 6,000

LUBRICATION

miles. Drain all old lubricant, install drain plug, and refill through filler plug hole.

(18) **SHOCK ABSORBER.** Every 6,000 miles remove plug and check level of fluid. If fluid is not up to plug level, disconnect link between arm and axle (par. 213). Fill to plug level with (SA) shock absorber fluid, light. Pump arm slowly to expel air from shock absorber. Repeat filling and pumping operations until all air is removed and fluid is at filler hole level. Install filler plug. Reconnect link between arm and axle (par. 213).

(19) **BRAKE MASTER CYLINDER.** Every 1,000 miles remove plug and check level of fluid. If fluid is not up to within ½ inch of filler hole, add sufficient (HB) hydraulic brake fluid, to bring fluid up to this level. Install filler plug. When it is evident that air is present in hydraulic system bleed entire system (par. 180).

(20) **OIL CAN POINTS.** Every 1,000 miles, lubricate pintle hook, hand brake linkage, brake pedal pull rod clevis pins, clutch pedal linkage; transfer case control lever bushings and clutch and brake pedal shaft if not equipped with fittings, with (OE) engine oil, seasonal grade, or (PS) preservative lubrication oil, special, below 0°F. (Water Tank)—Every 1,000 miles, lubricate control linkage on emergency valve and clevises, etc. with (OE) engine oil, seasonal grade or (PS) preservative lubricating oil, special, below 0° F. (Gas Tank)—Every 1,000 miles, lubricate selector operating valve handles and linkage, manhole cover hinges, etc., with (OE) engine oil, seasonal grade, or (PS) preservative lubricating oil, special, below 0°F.

(21) **POINTS REQUIRING NO LUBRICATION SERVICE.** Fan, water pump, clutch release bearing, generator (some models), springs.

(22) **DISASSEMBLED PERIODICALLY BY ORDNANCE MAINTENANCE PERSONNEL ONLY.**

(a) *Steering Column Upper Bearing.* Whenever steering column is removed for inspection or repair, clean and repack ball bearing with (WB) general purpose grease No. 2.

(b) *Steering Column Horn Contacts.* Whenever steering column is removed for inspection or repair, coat horn button contact washer lightly with (CG) general purpose grease, seasonal grade, to prevent corrosion.

(c) *Engine Breather.* Every 6,000 miles or more often under severe operating conditions, remove tube between valve cover and intake manifold, also valve attached to manifold. Thoroughly clean tube and valve and reassemble.

e. Reports and Records.

(1) Report unsatisfactory performance of materiel to the Ordnance Officer responsible for maintenance.

(2) A record of lubrication may be maintained in the Duty Roster (W.D., A.G.O. Form No. 6).

TRUCK, 2 1/2-TON, 6 x 6

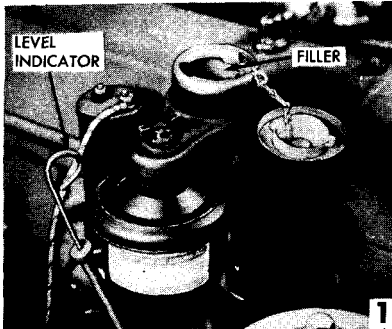

CRANKCASE—OE

Check level daily. Remove level indicator and clean with wiping cloth. Install and again remove. Oil level should be up to "Full" mark. Remove filler cap and fill or replenish through filler pipe. Install indicator and filler cap.

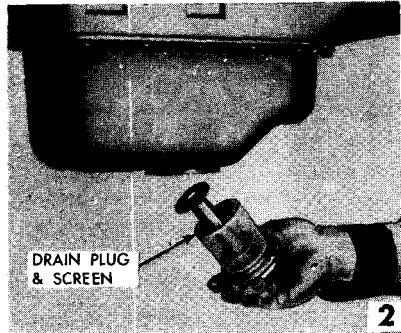

DRAINING CRANKCASE

Drain plug assembly. Drain when lubricant is warm, preferably immediately after operation. Remove drain plug and screen assembly. Clean in dry-cleaning solvent. Dry and reinstall plug assembly. Tighten plug securely.



OIL FILTER—OE

To drain, remove plug. To replace element, remove drain plug, filter cover and element. Install new military standard element, cover and drain plug. Run engine a few minutes and refill crankcase to "Full" mark on level indicator.

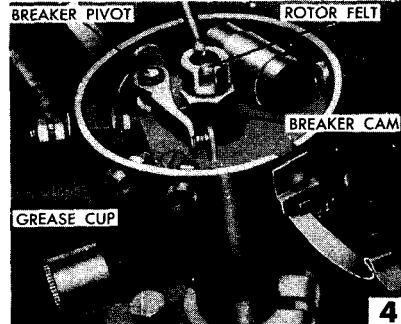

DISTRIBUTOR—OE—WB—CG

Shaft—Grease cup—WB. Turn cup down one full turn. Breaker Cams—CG. Apply sparingly. Breaker Pivot—OE. One drop one pivot. Rotor Wick—OE. Three or four drops on felt under rotor.



CRANKING MOTOR—OE

Two oilers. One each end. Fill oiler at commutator (front) end. Lubricate drive end (rear) bushing, while cranking motor is removed

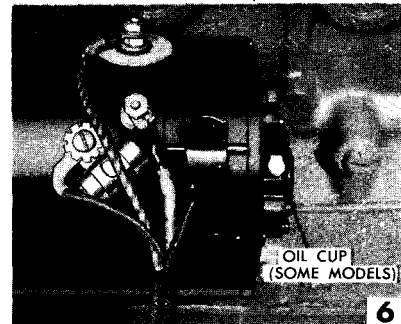

GENERATOR (Some Models)—OE

One oiler, on some models. Fill oiler at commutator (rear) end.

RA PD 333039

Figure 48—Lubrication Localized Views

LUBRICATION

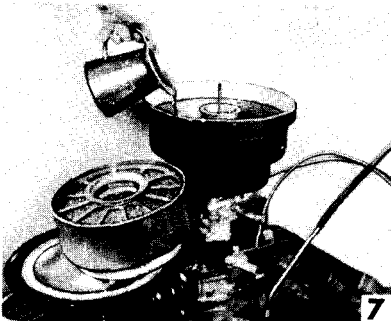

CARBURETOR AIR CLEANER (Clamp Mounted Type)—OE
Remove cover and element. Check oil level and cleanliness. Clean in dry-cleaning solvent. Dry thoroughly. Install reservoir and fill to "oil level" mark with OE, SAE 50 above +32 F or SAE 30 between -32 F and 0 F. From 0 F to -40 F use SA. Below -40 F operate dry. Install dry element and cover.



CARBURETOR AIR CLEANER (Flange Mounted Type)—OE
Remove cover and element assembly. Check oil level and cleanliness. Clean in dry-cleaning solvent. Dry thoroughly. Install reservoir and fill to "oil level" mark with OE, seasonal grade. From 0 F to -40 F use SA. Below -40 F operate dry. Install element dry.

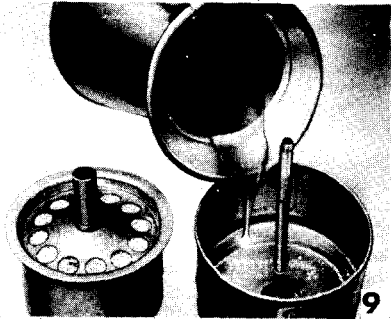

CRANKCASE VENTILATOR AND HYDROVAC AIR CLEANER (Some Models)—OE
Remove reservoir and element. Check oil level and cleanliness of element and reservoir. Clean in dry-cleaning solvent. Dry thoroughly. Fill reservoir to "oil level" mark with OE, seasonal grade. Position dry element in reservoir and install assembly.

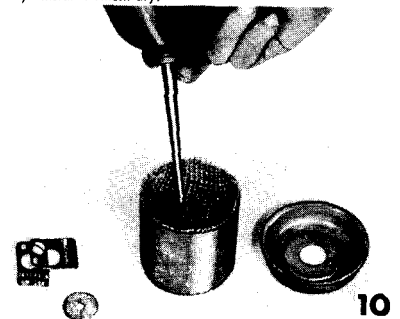

HYDROVAC AIR CLEANER (Some Models)—OE
Remove air cleaner assembly and disassemble. Wash all parts in dry-cleaning solvent. Dry and dip element in new SAE 10 engine oil. Reassemble and reinstall.

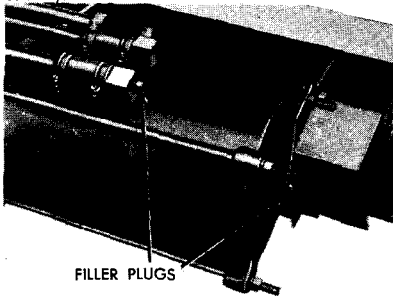

HYDROVAC CYLINDER—SA
Two plugs (one in elbow, one at rear). Oil can. Apply one-half ounce lubricant in each hole. Apply brakes several times to distribute oil along cylinder shells.

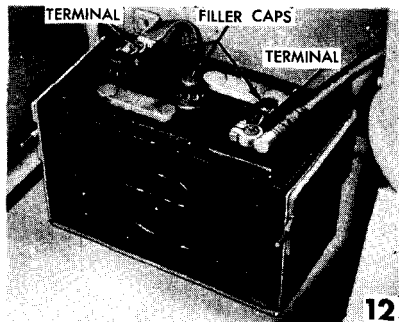

BATTERY TERMINALS—CG
Two terminals. Inspect cable terminals. If loose or corroded, remove and clean; install and tighten securely. Coat with general purpose grease. Check water level and, if necessary, add distilled water to $\frac{3}{8}$ " above plates.

Figure 49—Lubrication Localized Views

RA PD 333034

TRUCK, 2 1/2-TON, 6 x 6

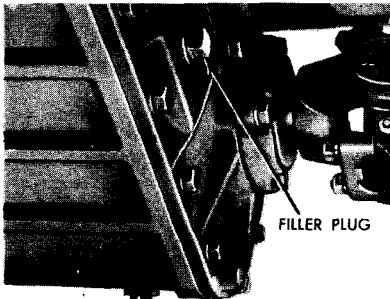

DRAIN PLUG

FILLER PLUG

13

TRANSFER CASE—Split Axle—GO

Filler and drain plugs. Pump gun. Clean vent and keep lubricant to level of filler hole. Drain when lubricant is warm, preferably immediately after operation.

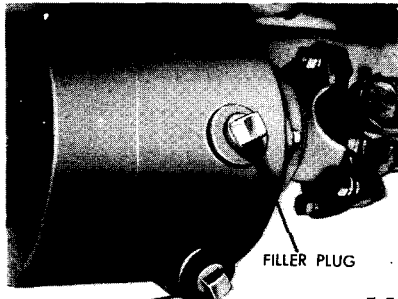

DRAIN PLUG

FILLER PLUG

14

TRANSFER CASE—Banjo Axle—GO

Filler and drain plugs. Pump gun. Clean vent and keep lubricant to level of filler hole. Drain when lubricant is warm, preferably immediately after operation.

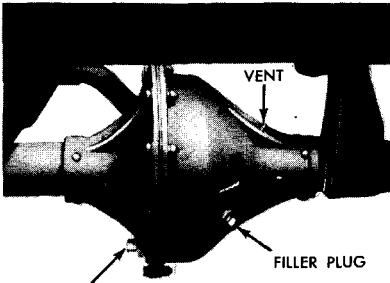

DRAIN PLUG

VENT

FILLER PLUG

15

AXLE DIFFERENTIAL—Split Housing—GO

Filler and drain plugs. Pump gun. Clean vent and keep lubricant to level of filler hole. Drain when lubricant is warm, preferably immediately after operation.

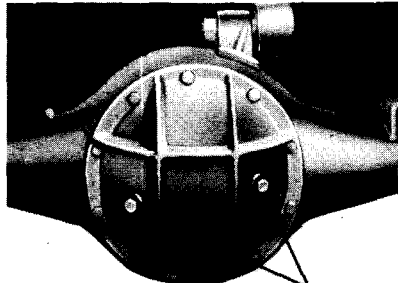

DRAIN SCREW

FILLER PLUGS

16

AXLE DIFFERENTIAL—Banjo Housing—GO

Filler plug and drain screw. Pump gun. Clean vent and keep lubricant to level of filler hole. Drain when lubricant is warm, preferably immediately after operation.

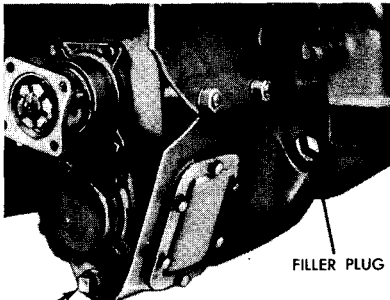

DRAIN PLUG

FILLER PLUG

17

TRANSMISSION—GO

Filler and drain plugs. Pump gun. Keep lubricant to level of filler hole. Drain when lubricant is warm, preferably immediately after operation. Do not flush.

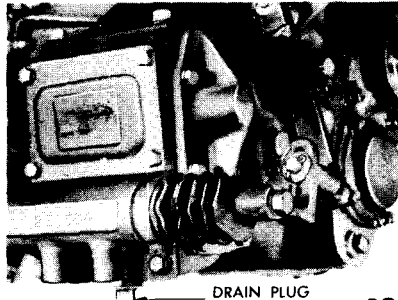

DRAIN PLUG (SOME MODELS)

18

POWER TAKE-OFF

Power take-off (when used) is equipped with drain plug on late vehicles. Remove drain plug at same time transmission is drained. Reinstall plug. Power take-off is lubricated by transmission lubricant. No method of draining is provided on early vehicles, except at transmission.

Figure 50—Lubrication Localized Views

RA PD 333040

LUBRICATION



CLUTCH RELEASE BEARING SUPPORT—WB
Fill recess inside of release bearing support with grease. Lubricant should be level with edges of recess.



RELEASE BEARING FORK GROOVE—WB
Apply light coat of grease to fork groove in release bearing support. Do not fill groove.

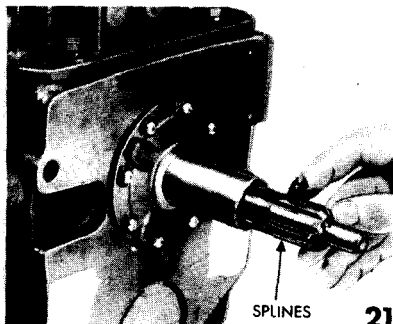

CLUTCH SHAFT SPLINES—WB
Apply light coat of grease to clutch shaft splines. Do not use excessive quantity.

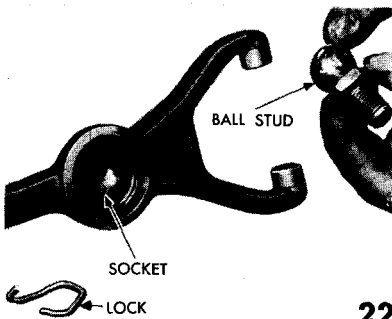

CLUTCH RELEASE FORK SOCKET AND STUD—WB
Apply light coat of grease to socket in release fork and to ball surface of stud. Install stud in fork socket and secure with lock.

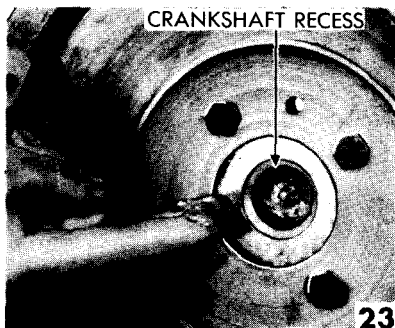

PILOT BEARING CRANKSHAFT RECESS—WB
Place a small amount of grease in crankshaft recess before installing pilot bearing.



CLUTCH PILOT BEARING—WB
Hand pack bearing with grease, being sure that all balls and races are coated.

Figure 51—Lubrication Localized Views

RA PD 333033

TRUCK, 2½-TON, 6 x 6

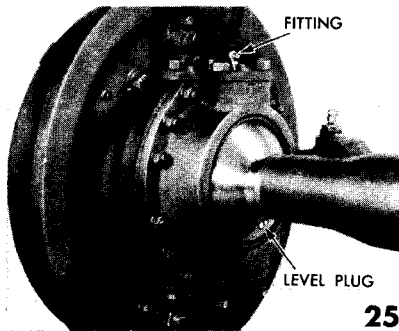

FRONT AXLE UNIVERSAL—Split—BENDIX—WEISS—CG

Two fittings and two level plugs. Pressure gun. Remove level plug and apply lubricant through fitting until visible at level plug. Replace level plug.

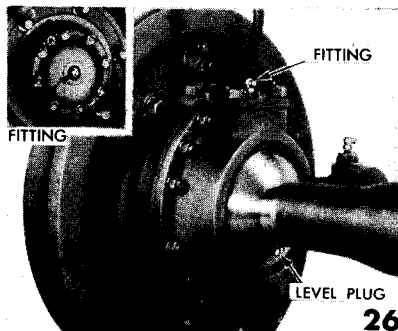

FRONT AXLE UNIVERSAL—Split—RZEPPA—CG

Two fittings and four plugs. Pressure gun. Remove level plug. Apply three or four shots through fitting. Remove drive flange plug and install temporary fitting. Lubricate through temporary fitting until visible at level hole. Remove temporary fitting and install two alvas.

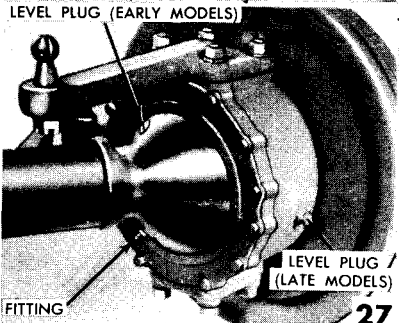

FRONT AXLE UNIVERSAL—Banjo—CG

Two fittings and two level plugs. Pressure gun. Remove level plug and apply lubricant through fitting, until visible at level plug. Replace level plug.

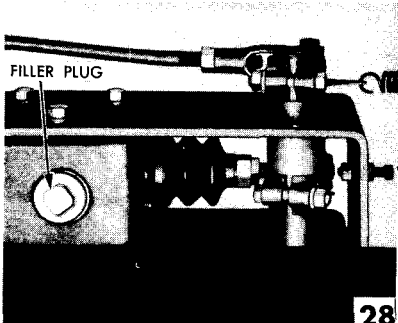

BRAKE MASTER CYLINDER—HB

Filler cap. Check level and, if necessary, add fluid until within 1" of filler hole. Bleed entire brake system, using pressure tank, if available, when evident that air is in hydraulic lines. Otherwise use pedal as pump.

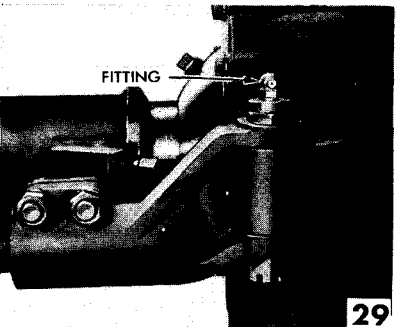

TIE ROD ENDS—CG

Two fittings (one each end). Pressure gun. Apply lubricant through fittings until new grease shows at insides of yoke.

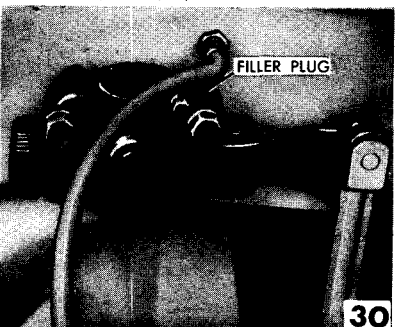

SHOCK ABSORBERS—SA

Two plugs (one each unit). Remove plug and check level of fluid. If necessary to replenish, remove link between arm and axle. Fill to capacity and pump arm to expel air. Repeat filling and pumping, until air is removed and fluid is at filler hole level. Install plug and connect link.

RA PD 333036

Figure 52—Lubrication Localized Views

LUBRICATION

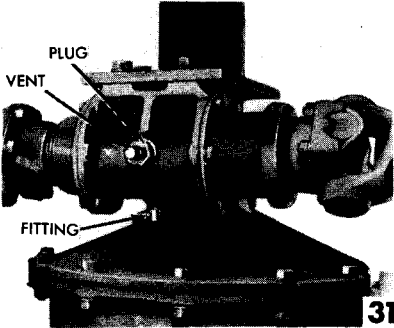

PILLOW BLOCK—CG

One fitting. Pump gun. Apply lubricant through fitting at side of housing, until lubricant flows from vent in plug at top of housing.

31

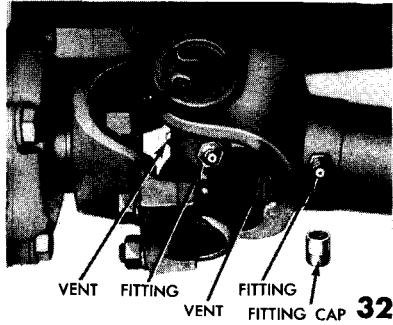

DRIVE PROPELLER SHAFT UNIVERSAL AND SLIP JOINTS—CG

Ten universal and five slip joints. Pressure gun. Apply lubricant through fitting until new lubricant shows through relief valve when lubricating universal or through vent at end of shaft when lubricating slip joint.

32

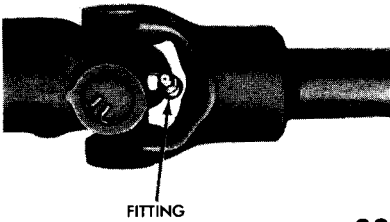

HOIST AND WINCH PROPELLER SHAFT UNIVERSAL JOINTS—CG

Two hoist and four winch universal joints. Pump gun. Apply lubricant through fitting until grease appears at journal.

33

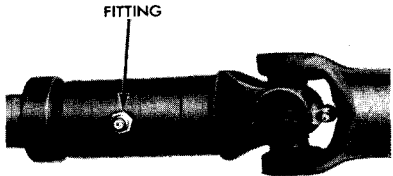

WINCH DRIVE SHAFT SLIP JOINT—CG

One fitting at rear of shaft. Pressure gun. Apply lubricant through fitting until grease appears between shaft and slip joint.

34

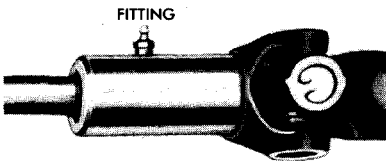

HOIST PROPELLER SHAFT SLIP JOINT—CG

One fitting at rear of shaft. Pump gun. Apply lubricant through fitting until grease appears between shaft and slip joint.

35

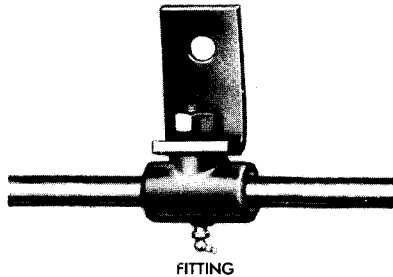

HOIST PROPELLER SHAFT SUPPORT BEARING—CG

Two fittings. Pump gun. Apply lubricant through fitting until new grease appears between bearing and shaft.

36

Figure 53—Lubrication Localized Views

TRUCK, 2 1/2-TON, 6 x 6

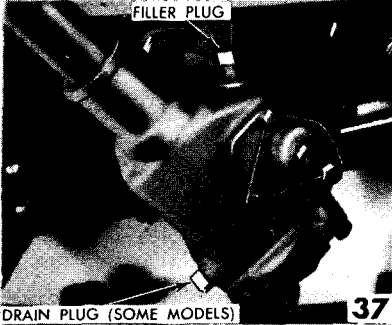

STEERING GEAR HOUSING—GO

Filler plug. Drain plug on late models. Pump gun. Remove drain plug (when used) to drain housing. Reinstall plug and fill to level of filler plug hole.

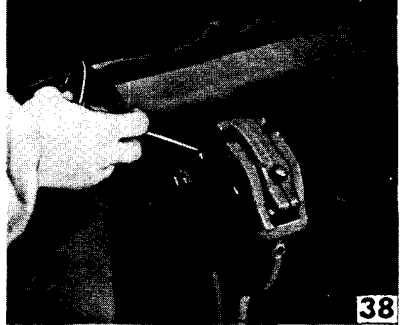

PINTLE HOOK—OE—CG

Oil can. Apply OE to pins, connections, and linkage surfaces. Remove pintle hook assembly. Clean bushings and hook assembly in dry-cleaning solvent. Lubricate bushings and hook shaft with CG, general purpose grease.

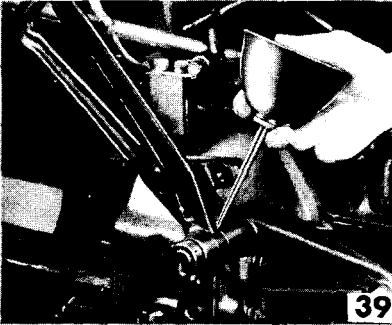

LINKAGE—OE

Oil can. Hand brake linkage, hand brake pull rod clevis pins, clutch pedal linkage. Also, clutch and brake pedal shaft and transfer case control lever, when not equipped with lubrication fittings.

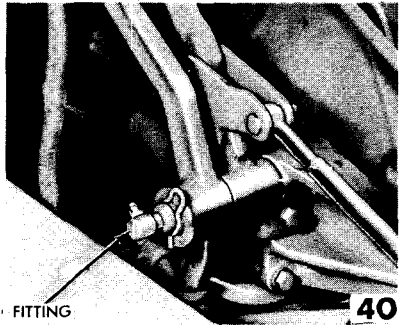

CLUTCH AND BRAKE PEDAL SHAFT—CG

One fitting. Pressure gun. Apply lubricant through fitting until new grease shows around pedals.

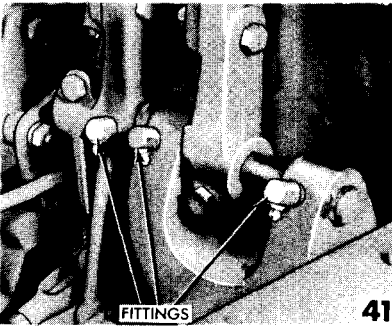

TRANSFER CASE CONTROL LEVERS—CG

Three fittings. Pressure gun. Apply lubricant through fittings until new grease shows around levers and bracket.

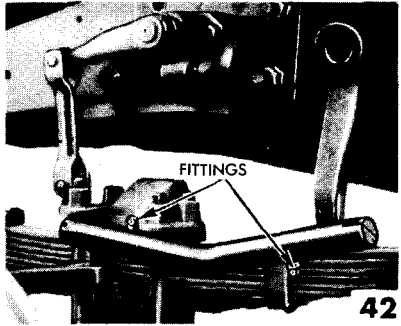

DRAG LINK—CG

Two fittings (one each end). Pressure gun. Apply lubricant through fittings until new grease shows around seats.

Figure 54—Lubrication Localized Views

RA PD 333037

LUBRICATION

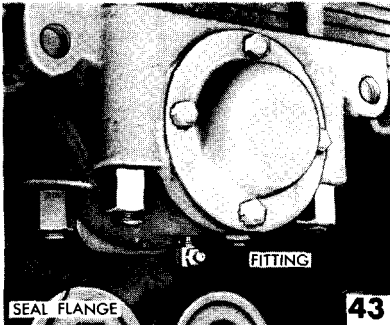

REAR SPRING SEAT BEARINGS
(Lip Type Seal on Late Models)—CG

Two fittings. Pressure gun. Apply lubricant through fitting until new grease appears between flange and seal at inside of seat.

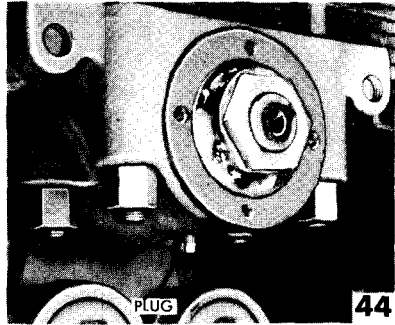

REAR SPRING SEAT BEARINGS
(Felt Type Seal on Early Models)—CG

Two spring seat caps. Remove pipe plug and install temporary fitting. Apply lubricant through fitting until new grease appears through outer bearing. Remove temporary fitting and install pipe plug. Install spring seat cap and gasket.

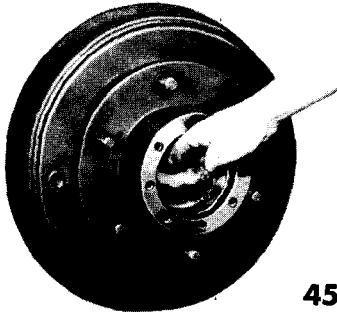

WHEEL HUBS—WB

Remove hub and bearings. Clean hub and bearings in dry cleaning solvent. Inspect bearings and, if cracked, chipped or pitted, replace with new part. Coat inside surface of hub and spindle thinly with grease to prevent corrosion. Do not fill hub. Reassemble and adjust bearings.

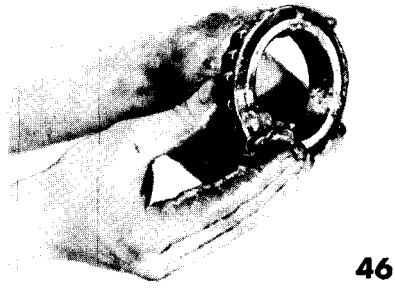

GREASE BEARING—WB—CG

Hand pack or bearing lubricator. Force grease into bearing with lubricator or, if not available, use hand method. Apply at big end of rollers until grease comes out between cage and race at small end of rollers. Smear grease around outside of cage and rollers.

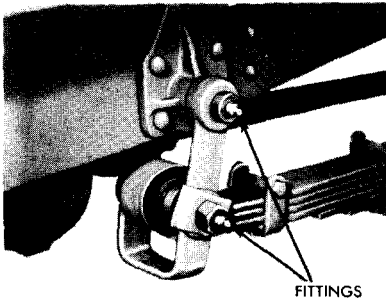

FRONT SPRING SHACKLES—CG

Four fittings (two each shackle). Pressure gun. Apply lubricant through fittings until new grease shows inside shackle.

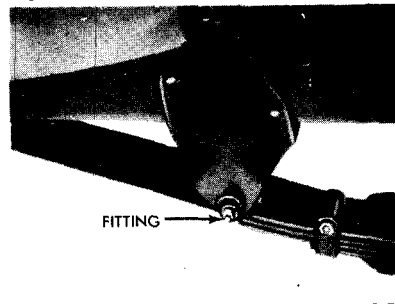

FRONT SPRING PIN—CG

Two fittings (one each side). Pressure gun. Apply lubricant through fittings until new grease shows at sides of spring.

Figure 55—Lubrication Localized Views

RA PD 333041

TRUCK, 2 1/2-TON, 6 x 6

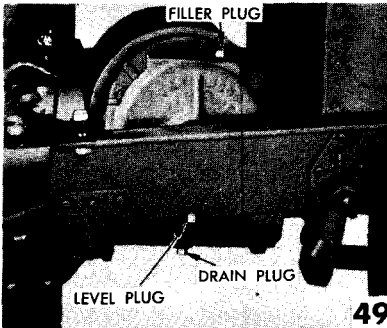

WINCH WORM HOUSING—GO

Filler, level and drain plugs. Pump gun. Lubricate through filler hole (top) until lubricant is up to level hole (side). Drain when lubricant is warm. Vent hole under name plate should be plugged.



WINCH DRUM BEARING—CG

Two fittings (one each end of drum). Pressure gun with adapter included in tool kit. Apply two or three shots of lubricant through fittings.

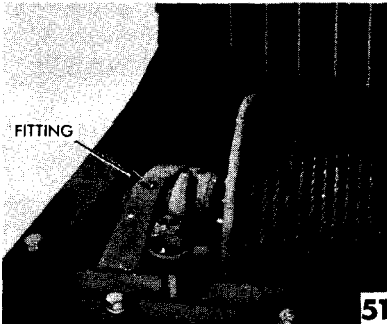

WINCH SHAFT—CG

One fitting (right end of shaft). Pressure gun with adapter included in tool kit. Apply lubricant through fitting until new grease shows at end of shaft.

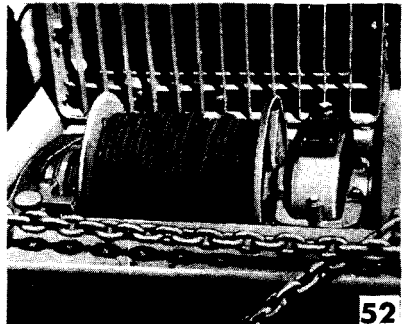

WINCH CABLE—OE

Oil can. Inspect full length of cable, and lubricate if surface is not oily or if rust is apparent.

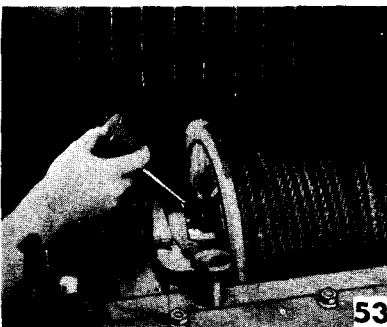

WINCH CLUTCH—OE

Oil can. Apply lubricant to sliding surface of jaw clutch yoke groove and linkage. Clean and re-oil when clutch sticks or when inspection shows to be dry.

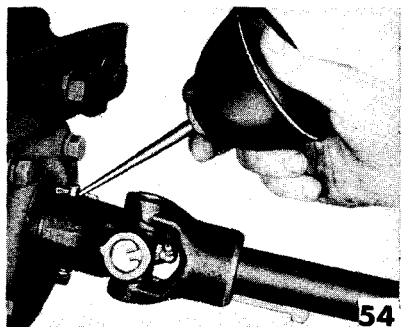

WINCH DRIVE SHAFT SHEAR PIN—OE

Oil can. Apply lubricant to both ends of pin and between yoke and worm shaft. If corroded condition is apparent, remove shear pin and yoke from shaft. Clean, lubricate and reassemble.

RA PD 333038

Figure 56—Lubrication Localized Views

Section IX

NEW VEHICLE RUN-IN TEST

38. PURPOSE.

a. When a new or reconditioned vehicle is first received at the using organization it is necessary for second echelon personnel to determine whether or not the vehicle will operate satisfactorily when placed in service. For this purpose, inspect all accessories, subassemblies, assemblies, tools, and equipment to see that they are in place and correctly adjusted. In addition, they will perform a run-in test of at least 50 miles as directed in AR 850-15, paragraph 25, table III, according to procedures in paragraph 40 below.

39. CORRECTION OF DEFICIENCIES.

a. Deficiencies disclosed during the course of the run-in test will be treated as follows:

(1) Correct any deficiencies within the scope of the maintenance echelon of the using organization before the vehicle is placed in service.

(2) Refer deficiencies beyond the scope of the maintenance echelon of the using organization to a higher echelon for correction.

(3) Bring deficiencies of serious nature to the attention of the supplying organization.

40. RUN-IN TEST PROCEDURES.

a. **Preliminary Service.**

(1) **FIRE EXTINGUISHER.** See that portable extinguisher is present and in good condition. Test it momentarily for proper operation, and mount it securely.

(2) **FUEL, OIL, AND WATER.** Fill fuel tank. Check crankcase oil and coolant supply, and add as necessary to bring to correct levels. Allow room for expansion in fuel tanks and radiator. During freezing weather, test value of antifreeze and add as necessary to protect cooling system against freezing. **CAUTION:** *If there is a tag attached to filler cap or steering wheel concerning engine oil in crankcase, follow instructions on tag before driving the vehicle.*

(3) **FUEL FILTER.** Inspect fuel filter for leaks, damage, and secure mountings and connections. Drain filter sediment bowl. If any appreciable amount of water or dirt is present, remove bowl, and clean bowl and element in dry-cleaning solvent. Also drain accumulated water or dirt from bottom of fuel tank. Drain only till fuel runs clean.

(4) **BATTERY.** Make hydrometer and voltage test of battery, and add clean water to bring electrolyte $\frac{3}{8}$ inch above plates.

(5) **AIR CLEANERS AND VENTILATORS.** Inspect carburetor air cleaner and crankcase ventilator units to see if they are in good condition. Remove air cleaner reservoir and element and clean and

TRUCK, 2½-TON, 6 x 6

service according to lubrication order, paragraph 37. Service crank-case ventilator valve according to paragraph 82.

(6) **ACCESSORIES AND BELTS.** See that accessories such as carbureter, generator, regulator, cranking motor, water pump, fan, and oil filters are in good condition and secure. Be sure fan and generator drive belt is in good condition and adjusted to provide ½ inch finger pressure deflection.

(7) **ELECTRICAL WIRING.** Examine all accessible wiring and conduits to see if they are in good condition, securely connected, and properly supported.

(8) **TIRES.** See that all tires, including spares, are properly inflated to 55 pounds (maximum) cool; that stems are in correct position; all valve caps present and finger-tight. Remove objects lodged in treads, carcasses, and between duals. Inspect for damage.

(9) **WHEEL AND FLANGE NUTS.** See that all wheel mounting and axle flange nuts or cap screws are present and secure.

(10) **FENDERS AND BUMPERS.** Examine fenders and bumper for looseness and damage.

(11) **TOWING CONNECTIONS.** Examine all towing devices to see that they are in good condition and securely mounted. Be sure pintle hook operates and latches properly.

(12) **BODY, CAB, TARPAULIN.** Inspect all types of bodies, (cargo, dump, and water tank) for damage, loose mountings, attachments, hardware, and condition of paint and markings. Be sure cabs are secure; that soft top and frames are in good condition; that tarpaulins, (where used) are not damaged and are installed or stowed properly. On tanks, be sure filler caps and drain valve are in good condition, that they operate properly, and do not leak.

(13) **LUBRICATE.** Perform a complete lubrication of the vehicle, covering all intervals, according to the instructions on the lubrication order, paragraph 37, except gear cases, wheel bearings, and other units covered in preceding procedures. Check all gear case oil levels, and add as necessary to bring to correct level. Change only if condition of oil indicates the necessity, or if gear oil is not of proper grade for existing atmospheric temperature. *NOTE: Perform items (14) to (17) during lubrication.*

(14) **SPRINGS AND SUSPENSION.** Inspect front and rear springs, shock absorbers and links, torque rods, and rear spring seats for looseness and damage. Check shocks and spring seats for leakage, and proper oil or fluid levels. Look for spring sag and shifted leaves.

(15) **STEERING LINKAGE.** Inspect steering gear case, all arms, rods and connections, column and wheel, to be sure they are in good condition, properly assembled and securely connected or mounted. Check gear case for proper oil level and leaks.

(16) **PROPELLER SHAFTS, PILLOW BLOCK, AND VENT.** Inspect all shafts, universal joints, and pillow block to see if they are in good condition, correctly assembled, aligned, secure, and not leaking excessively at seals or vents. Be sure vent passages are not clogged.

(17) **AXLE AND TRANSFER CASE VENTS.** Examine these units for looseness, damage, and see that they are not clogged.

NEW VEHICLE RUN-IN TEST

(18) **CHOKE.** Examine choke to be sure it opens and closes fully in response to operation of choke button.

(19) **ENGINE WARM-UP.** Start engine, noting if cranking motor action is satisfactory, and any tendency toward hard starting. Set hand throttle to run engine at fast idle during warm-up. During warm-up, reset choke button so engine will run smoothly, and to prevent overchoking and oil dilution.

(20) **INSTRUMENTS.**

(a) **Oil Pressure Gage.** Pressure should be 35 to 40 pounds at operating speeds and about 5 pounds at idle speed. Stop engine if pressure is not evident in 30 seconds.

(b) **Ammeter.** Gage should show a positive (+) charge for a period after starting, until generator restores to battery the current used in starting, then a zero or only slight charge if battery is up and with all lamps and accessories turned off.

(c) **Engine Temperature Gage.** Reading should increase gradually during warm-up, to normal operating range, 160°F to 185°F. Maximum safe operating temperature, 220°F (205°F at high altitudes). **CAUTION: Do not move vehicle until engine temperature has reached at least 140°F.**

(d) **Fuel Gage.** Gage should register the approximate amount of fuel in tank.

(21) **ENGINE CONTROLS.** Observe if engine responds properly to controls, and if controls operate without excessive looseness or binding.

(22) **HORN AND WINDSHIELD WIPERS.** See that these items are in good condition and secure. If tactical situation permits, test horn for proper operation and tone. See if wiper arms will operate through their full range and that blade contacts glass evenly and firmly.

(23) **GLASS AND REAR VIEW MIRRORS.** Clean all cab glass and mirrors and inspect for looseness and damage. Adjust rear view mirrors for correct vision.

(24) **LAMPS (LIGHTS) AND REFLECTORS.** Clean lenses and inspect all units for looseness and damage. If tactical situation permits, open and close all light switches to see if lamps respond properly.

(25) **LEAKS—GENERAL.** Look on ground under vehicle, and within engine compartment for evidence of fuel, oil, or water leaks, and around axles and transmission for evidence of grease leaks. Trace all leaks to their source and correct or report them.

(26) **TOOLS AND EQUIPMENT.**

(a) **Tools.** Check tool lists, paragraph 7, to be sure they are all present, and be sure they are in good condition and properly mounted or stowed.

(b) **Equipment.** Check On Vehicle Stowage Lists (pars. 8 and 9) to be sure all items of standard or special equipment are present, in good condition and properly mounted or stowed.

(c) **Winch.** Inspect winch assembly to see that it is in good condition, correctly and securely assembled and mounted and not leaking. Test operation of sliding clutch and inspect automatic brake

TRUCK, 2 1/2-TON, 6 x 6

mechanism for looseness or damage. Unwind winch cable and examine. Clean it with a rag saturated with thin oil or kerosene. As it is rewound evenly and tightly, apply a thin film of clean engine oil. Fasten cable chain hook securely.

(d) *Hoist.* Raise dump body with hoist and inspect mountings, drive, controls, pump and lines, and cylinder for looseness, damage, and leaks at pump, lines, or cylinder. Stop engine with body up and observe any tendency of body to drop. When lowering body, see that it lowers fully and that guides aline body with frame. Check or fill hoist cylinder according to lubrication order, paragraph 37.

b. *Run-in Test.* Perform the following procedures, (1) to (10) inclusive, during the road test of the vehicle. On vehicles which have been driven 50 miles or more in the course of delivery from the supplying to the using organization, reduce the length of the road test to the least mileage necessary to make observations listed below. **CAUTION:** *Avoid continuous operation of the vehicle at speeds approaching the maximums indicated on the caution plate.*

(1) **DASH INSTRUMENTS AND GAGES.** Do not move vehicle until engine temperature reaches 140°F. Maximum safe operating temperature, 220°F. Observe readings of ammeter, oil, temperature, and fuel gages to be sure they are indicating the proper function of the units to which they apply. Also see that speedometer registers the vehicle speed and that odometer registers total accumulating mileage.

(2) **BRAKES, FOOT AND HAND.** Operate brakes at various speeds during road test. Apply foot pedal sufficiently to stop vehicle in minimum distance and observe effectiveness, any pull to one side, unusual noise, chatter, and pedal travel. Stop vehicle on incline, apply parking brake and note if it holds vehicle. Note if lever has sufficient reserve after application and that pawl and sector lock applied brakes securely.

(3) **CLUTCH.** Note pedal free-travel (paragraph 150). Check clutch for drag when shifting into low gear. Note any unusual noise when pedal is depressed which may indicate defective release bearing. With transmission in gear, note any tendency of clutch to chatter, grab when clutch is engaged, or slippage when fully engaged under load.

(4) **TRANSMISSION AND TRANSFER UNIT.** Shift mechanism of transmission and power take-off, transfer and declutching unit should operate easily and smoothly and gears should operate without excessive noise and not slip out of mesh during operation.

(5) **STEERING.** Observe steering action for binding or looseness, and note any excessive pull to one side, wander, shimmy, or wheel tramp. See that column bracket and wheel are secure.

(6) **ENGINE.** Be on the alert for any abnormal engine operating characteristics or unusual noise, such as lack of pulling power or acceleration; back-firing, misfiring, stalling, overheating, or excessive exhaust smoke. Observe if engine responds properly to all controls.

(7) **UNUSUAL NOISE.** Be on the alert throughout road test for any unusual noise from body, cab and attachments, running gear,

NEW VEHICLE RUN-IN TEST

suspension units, or wheels that might indicate looseness, damage, inadequate lubrication, or under-inflated tires.

(8) **HALT VEHICLE AT 10-MILE INTERVALS FOR SERVICES (9) AND (10) BELOW.**

(9) **TEMPERATURES.** Cautiously hand-feel each brake drum and wheel hub for abnormal temperatures. Examine transmission, transfer case, and differential housings for overheating and excessive oil leaks at seals or gaskets. **NOTE:** *Transfer case temperatures are normally greater than other gear cases.*

(10) **LEAKS.** With engine running, and fuel, engine oil, and cooling systems under pressure, look within engine compartment and under vehicle for indications of leaks.

c. **Vehicle Publications and Reports.**

(1) **PUBLICATIONS.** See that vehicle Technical Manuals, Lubrication order, Standard Form No. 26 (Driver's Report-Accident, Motor Transportation) and W.D., A.G.O. Form No. 478 (HWO and Major Unit Assembly Replacement Record), are in the vehicle, legible, and properly stowed. **NOTE:** *U.S.A. registration number and vehicle nomenclature must be filled in on Form No. 478, for new vehicles.*

(2) **REPORTS.** Upon completion of the Run-in Test, correct or report any deficiencies noted. Report general condition of the vehicle to designated individual in authority.

Section X

FIRST ECHELON PREVENTIVE MAINTENANCE SERVICE

41 PURPOSE.

a. To insure mechanical efficiency, it is necessary that the vehicle be systematically inspected at intervals each day it is operated and weekly, so defects may be discovered and corrected before they result in serious damage or failure. Certain scheduled maintenance service will be performed at these designated intervals. The services set forth in this section are those performed by drivers or crew, Before-Operation, During-Operation, At-Halt, and After-Operation and Weekly.

b. Driver Preventive Maintenance Services are listed on the back of "Drivers Trip Ticket and Preventive Maintenance Service Record" WD Form No. 48 to cover vehicles of all types and models. Items peculiar to specific vehicles but not listed on WD Form No. 48 are covered in manual procedures under the items with which they are related. Certain items listed on the form that do not pertain to the vehicle involved are eliminated from the procedures as written into the manual. Every organization must thoroughly school each

TRUCK, 2½-TON, 6 x 6

driver in performing the maintenance procedures set forth in manuals whether they are listed specifically on WD Form No. 48 or not.

c. The items listed on WD Form No. 48 that apply to this vehicle are expanded in this manual to provide specific procedures for accomplishment of the inspections and services. These services are arranged to facilitate inspection and conserve the time of the driver and are not necessarily in the same numerical order as shown on WD Form No. 48. The item numbers, however, are identical with those shown on that form.

d. The general inspection of each item applies also to any supporting member or connection, and generally includes a check to see whether the item is in good condition, correctly assembled, secure, or excessively worn.

e. The inspection for "good condition" is usually an external visual inspection to determine whether the unit is damaged beyond safe or serviceable limits. The term good condition is explained further by the following terms: Not bent or twisted, not chafed or burned, not broken or cracked, not bare or frayed, not dented or collapsed, not torn or cut.

f. The inspection of a unit to see that it is "correctly assembled" is usually an external visual inspection to see whether it is in its normal assembled position in the vehicle.

g. The inspection of a unit to determine if it is "secure" is usually an external visual examination, a wrench, hand-feel, or a pry-bar check for looseness. Such an inspection should include any brackets, lock washers, lock nuts, locking wires, or cotter pins used in assembly.

h. "Excessively worn" will be understood to mean worn, close-to or beyond serviceable limits, and likely to result in a failure if not replaced before the next scheduled inspection.

i. Any defects or unsatisfactory operating characteristics beyond the scope of first echelon to correct must be reported at the earliest opportunity to the designated individual in authority.

42. BEFORE-OPERATION SERVICE.

a. This inspection schedule is designed primarily as a check to see that the vehicle has not been damaged, tampered with, or sabotaged since the "After-Operation Service" was performed. Various combat conditions may have rendered the vehicle unsafe for operation and it is the duty of the driver to determine whether or not the vehicle is in condition to carry out any mission to which it is assigned. This operation will not be entirely omitted, even in extreme tactical situations.

b. **Procedures.** Before-Operation Service consists of inspecting items listed below according to the procedure described, and correcting or reporting any deficiencies. Upon completion of the service, results should be reported promptly to the designated individual in authority.

(1) **ITEM 1, TAMPERING AND DAMAGE.** Examine the vehicle, accessories, and equipment for damage, caused by tampering or

FIRST ECHELON PREVENTIVE MAINTENANCE SERVICE

sabotage, collision, falling debris, or shell fire since parking. Examine the interior of engine compartment for evidence of above conditions, and for loosened or damaged engine accessories or drive belt, leaking fuel, disconnected oil lines, coolant lines, and control linkage.

(2) **ITEM 2, FIRE EXTINGUISHER.** See that unit is in good condition, fully charged, (open filler plug to check contents) and that nozzle is not clogged. Mount extinguisher securely.

(3) **ITEM 3, FUEL, OIL, AND WATER.** Check amount of fuel in tank. Check crankcase oil level on dip stick. Examine coolant level in radiator. Add fuel as necessary to complete mission, or to operate vehicle to next scheduled refueling point. Add engine oil to crankcase and coolant to radiator as needed to bring to correct levels. **NOTE:** *Any appreciable drop in levels since the last "After-Operation Service" must be investigated, and cause corrected or reported.* During freezing weather when antifreeze solution is in use, if an excessive addition of water is needed, antifreeze value must be checked by 2nd echelon and added if necessary. Spare fuel, oil, and water cans must be full and securely mounted.

(4) **ITEM 4, ACCESSORIES AND DRIVES.** Examine units such as carburetor, generator, regulator, cranking motor, fan, oil filter, and air cleaner for looseness and damage. Make certain that water pump and generator drive belt is in good condition and that adjustment is satisfactory ($\frac{1}{2}$ inch finger pressure deflection).

(5) **ITEM 6, LEAKS—GENERAL.** Inspect ground under vehicle and within engine compartment for indications of fuel, engine oil, coolant, and gear oil or brake fluid leaks. Trace any leaks found to their source, and correct or report them.

(6) **ITEM 8, CHOKE.** As engine is started in item 7, below, observe if choke action is satisfactory.

(7) **ITEM 7, ENGINE WARM-UP.** Start engine noting any tendency toward hard starting; if cranking motor has adequate cranking speed, and engages and disengages without unusual noise. Set hand throttle to run engine at fast idle during warm-up, and reset choke as necessary for engine to run smoothly and to prevent over-choking and oil dilution.

(8) **ITEM 9, INSTRUMENTS.**

(a) **Oil Gage.** Oil pressure should be approximately five pounds at slow idling speed.

(b) **Ammeter.** With battery fully charged and all lights and accessories turned off, ammeter may show a slight positive charge with engine at fast idle. A high charge reading may be indicated immediately after starting until generator restores to battery current used in starting. High charge may be indicated for some time if battery charge is low or electric load is heavy.

(c) **Engine Temperature Gage.** Reading should increase gradually during warm-up period to normal operating range. Temperatures between 160°F, and 220°F (205°F at high altitudes) are satisfactory for efficient engine operation. Temperatures above 220°F (205°F at high altitudes) or below 160°F indicate a deficiency. Engine must be

TRUCK, 2½-TON, 6 x 6

stopped and trouble located and corrected. Do not move vehicle until temperature reaches 140°F.

(d) *Fuel Gage.* Observe if gage registers level of fuel in tank. Ordinarily tank should have been filled during "After-Operation Service" and gage should read "FULL."

(9) **ITEM 10, HORN AND WINDSHIELD WIPERS.** If tactical situation permits, test horn for proper operation and tone. Test wipers to see that they operate properly, and observe whether the blades contact glass evenly and arms travel through full stroke. Inspect for damage.

(10) **ITEM 11, GLASS AND REAR VISION MIRROR.** Clean all glass and inspect for damage. Check adjustment of rear vision mirror and see that it is secure.

(11) **ITEM 15, SPRINGS AND SUSPENSION.** Examine springs, shock absorbers, torque rods, and rear spring seats and bearing caps to see that they are in good condition; that all assembly mounting nuts and screws are secure, and that shock absorbers and bearing caps are not leaking.

(12) **ITEM 16, STEERING LINKAGE.** Inspect steering gear housing mounting bolts, all steering rods, and all joints for looseness or damage. Examine steering gear housing for lubricant leaks.

(13) **ITEM 13, WHEEL AND FLANGE NUTS.** See that all wheel mounting, and axle flange nuts or cap screws, are present and secure (see paragraphs 167, 171 and 172).

(14) **ITEM 14, TIRES.** Examine tires including spare, for under inflation. Correct pressure is 55 pounds (maximum) cool. Inspect them for damage, and remove any embedded objects from treads and carcass and from between duals.

(15) **ITEM 18, TOWING CONNECTIONS.** Inspect all towing devices for looseness or damage. Be sure pintle operates freely and locks securely. See that winch cable chain and hook are in good condition and secured to front tow hooks.

(16) **ITEM 19, BODY, LOAD AND TARPS.** Inspect body for looseness and damage. Be sure dump body is in alinement with frame and guides; that tail gate is closed and secured. Examine filler openings and drain cocks on water tank to be sure they are closed and locked and inspect tank for leaks. Inspect cargo load for damage and proper distribution. See that tarpaulin is in good condition and that all ropes are properly lashed to body hooks.

(17) **ITEM 12, LAMPS (LIGHTS) AND REFLECTORS.** See that all lights and warning reflectors are clean. Examine them for looseness or damage. If tactical situation permits, open and close switches and observe if lamps respond properly. Include stop and blackout lights.

(18) **ITEM 17, FENDERS AND BUMPERS.** Inspect fenders, bumpers, and running boards for looseness or damage.

(19) **ITEM 20, DECONTAMINATOR.** Be sure decontaminator is present, fully charged and secure. Remove filler plug to check contents.

(20) **ITEM 21, TOOLS AND EQUIPMENT.** Be sure all items are present, serviceable, and properly mounted or stowed (Section III).

FIRST ECHELON PREVENTIVE MAINTENANCE SERVICE

(21) **ITEM 22, ENGINE OPERATION.** Before vehicle is put in motion, be sure it has reached a satisfactory operating temperature, (at least 140°F) and that it idles smoothly with choke wide open. Accelerate and decelerate engine and listen for any unusual noise. Note any unsatisfactory operating characteristics or excessive exhaust smoke.

(22) **ITEM 23, DRIVER'S PERMIT AND FORM 26.** Driver must have his operator's permit on his person. Check to see that accident Form No. 26, Operator's Manual, Lubrication Order, and W.D., A.G.O. Form No. 478 are present in vehicle, legible and properly stowed.

(23) **ITEM 25, DURING-OPERATION CHECK.** The During-Operation Services and observations start immediately the vehicle is put in motion as follows:

43. DURING-OPERATION SERVICE.

a. While vehicle is in motion, listen for any sounds such as rattles, knocks, squeals, or hums that may indicate trouble. Look for indications of trouble in cooling system and smoke from any part of the vehicle. Be on the alert to detect any odor of overheated components or units such as generator, brakes or clutch, fuel vapor from a leak in fuel system, exhaust gas or other signs of trouble. Any time the brakes are used, gears shifted, or vehicle turned, consider this a test and notice any unsatisfactory or unusual performance. Watch the instruments constantly. Notice promptly unusual instrument indication that may signify possible trouble in system to which the instrument applies.

b. **Procedures.** During-Operation Services consist of observing items listed below according to the procedures following each item, and investigating any indications of serious trouble. Notice minor deficiencies to be corrected or reported at earliest opportunity, usually next scheduled halt.

(1) **ITEM 27, FOOT AND HAND BRAKES.** Foot brakes should stop vehicle smoothly and effectively with normal pedal pressure and return to off position immediately pedal is released. Pedal should have ½ inch free travel before meeting resistance and pedal to floor board clearances should be ½ to 1 inch when fully released. Hand brake should latch securely, and hold vehicle on reasonable incline, leaving at least 1/3 ratchet travel in reserve.

(2) **ITEM 33, STEERING GEAR.** Note any indication of looseness or binding, pull to one side, wandering, shimmy, wheel tramp, or unusual noise.

(3) **ITEM 28, CLUTCH.** Clutch should not grab, chatter or squeal during engagement or slip when fully engaged under load. Pedal should have 2½ inches free travel and never less than 1 inch before meeting resistance (see paragraph 150).

(4) **ITEM 29, TRANSMISSION.** Transmission and power take-off should shift smoothly, operate without unusual noise, and gears should not slip out of mesh during operation. Be sure power take-off control lever latch holds ever securely.

TRUCK, 2½-TON, 6 x 6

(5) **ITEM 30, TRANSFER.** Transfer unit range gears and de-clutching mechanism should shift easily, operate without unusual noise, and not creep out of mesh during operation.

(6) **ITEM 31, ENGINE AND CONTROLS.** The driver must be on the alert for deficiencies in engine performance such as lack of usual power, misfiring or stalling, unusual noise, indications of overheating or excessive exhaust smoke. Observe if engine responds to all controls and if controls appear to be in proper adjustment and not excessively loose or binding.

(7) **ITEM 32, INSTRUMENTS.** Observe all pertinent instrument readings frequently during operation, to be sure they indicate or record the proper function of the unit or system to which they apply. Observe if speedometer registers vehicle speed in miles per hour, and if odometer records accumulating mileage.

(8) **ITEM 34, RUNNING GEAR.** Be on the alert for any unusual operating characteristics or noise from wheels, axles, or suspension units that might indicate looseness or damage or underinflated tires.

(9) **ITEM 35, BODY.** Note any noise or abnormal condition that might indicate shifting, loose tarpaulins or curtain, loose or damaged doors, hardware (closed type cab), floor or inspection plates or body attachments. Make certain that top, rear, and side curtains on open type cab are secure.

44. AT-HALT SERVICE.

a. At-Halt Services may be regarded as minimum maintenance procedures and should be performed under all tactical conditions even though more extensive maintenance services must be slighted or omitted altogether.

b. **Procedures.** At-Halt Services consist of investigating any deficiencies noted during operation, inspecting items listed below according to the procedures following the items, and correcting any deficiencies found. Deficiencies not corrected should be reported promptly to the designated individual in authority.

(1) **ITEM 38, FUEL, OIL, AND WATER SUPPLY.** Check the fuel, oil, and coolant supply to see that it is adequate to operate the vehicle to the next scheduled halt. If engine is hot, add coolant slowly while engine is running at a fast idle. Make sure vent in fuel tank cap is open and valve free.

(2) **ITEM 47, ACCESSORIES AND BELTS.** Examine all accessible units for looseness or damage. Be sure fan and generator belt deflection is ½ inch. If radio noise caused by operation of the engine has been reported, examine all wiring and radio noise suppression devices in engine compartment for damage, loose connections or mountings. Look particularly for scorched, loose or damaged resistor-suppressors at spark plugs and distributor.

(3) **ITEM 48, AIR CLEANERS.** If operating under extremely dusty or sandy conditions, inspect the air cleaners and breather cap to see that they are in condition to deliver clean air properly. Service if necessary.

FIRST ECHELON PREVENTIVE MAINTENANCE SERVICE

(4) **ITEM 39, TEMPERATURES, HUBS, BRAKES, AND DRUMS.** Place hand cautiously on each brake drum and wheel hub and note if it is overheated.

(5) **ITEM 46, LEAKS—GENERAL.** Look under vehicle and within engine compartment for indications of fuel, oil, brake fluid, or coolant leaks. Trace any leaks found to their source and correct or report them.

(6) **ITEM 43, STEERING LINKAGE.** Examine all steering control mechanism, arms and linkage joints for looseness or damage. Investigate any unusual condition noted during operation.

(7) **ITEM 40, AXLE AND TRANSFER CASE VENTS.** Inspect transfer case, transmission, and axle housing for overheating and note any excessive lubricant leaks. Wipe clean and inspect axle housing and transfer case vents for damage or clogging. Vents must be kept open.

(8) **ITEM 41, PROPELLER SHAFTS.** Inspect all propeller shafts and universal joints for looseness, damage, and excessive lubricant leaks. Remove any foreign matter entangled around shafts or universal joints.

(9) **ITEM 42, SPRINGS AND SUSPENSIONS.** Inspect for broken or shifted spring leaves, damaged or loose U-bolts, shackles, rebound clips or shock absorber bodies and linkage, or excessive shock absorber fluid leaks. Ascertain that torque rods are secure and not damaged, and rear spring seat bearing caps are tight and not leaking excessive lubricant.

(10) **ITEM 44, WHEEL AND FLANGE NUTS.** See that all wheel mounting and axle flange nuts or cap screws are present and secure.

(11) **ITEM 45, TIRES.** Inspect all tires for under inflation or damage. Remove embedded objects in treads or carcasses and from between duals. See that spare is inflated and secure in carrier.

(12) **ITEM 49, FENDERS AND BUMPERS.** Inspect bumpers and fenders and rear splash guards for looseness or damage.

(13) **ITEM 50, TOWING CONNECTIONS.** Inspect front tow hooks and rear pintle hook to be sure they are in good condition, securely mounted, and if in use, that they are properly connected. Be sure winch (when used) cable and cable chain are properly wound and secured to front tow hooks.

(14) **ITEM 51, BODY LOAD AND TARPS.** Inspect for indications of cab, body or load shifting and for damage, and be sure tarpaulin (when used) is properly secured.

(15) **ITEM 52, GLASS.** Clean all windshield, mirror, light, and warning reflector glass and inspect for damage.

45. AFTER-OPERATION AND WEEKLY SERVICES.

a. After-Operation Servicing is particularly important because at this time the driver inspects his vehicle to detect any deficiencies that may have developed and corrects those he is permitted to handle. He should report promptly, to the designated individual in authority the results of his inspection. If this schedule is performed thoroughly, the vehicle should be ready to roll again on a moment's notice. The Before-Operation Service, with a few exceptions, is then

TRUCK, 2½-TON, 6 x 6

necessary only to ascertain whether the vehicle is in the same condition in which it was left upon completion of the After-Operation Service. The After-Operation Service should never be entirely omitted even in extreme tactical situations, but may be reduced to the bare fundamental services outlined for the At-Halt Service if necessary.

b. Procedures. When performing the After-Operation Service the driver must remember and consider any irregularities noticed during the day in the Before-Operation, During-Operation, and At-Halt Services. The After-Operation Service consists of inspecting and servicing the following items. Those items of the After-Operation Service that are marked by an asterisk (*) require additional weekly services, the procedures for which are indicated in subparagraph (b) of each applicable item.

(1) **ITEM 55, ENGINE OPERATION.** Accelerate and decelerate engine and note any tendency to miss or backfire. Listen for any unusual noise or vibration. Note any unusual exhaust smoke. Investigate and correct or report any deficiencies noted during operation.

(2) **ITEM 56, INSTRUMENTS.** Check all pertinent instruments to be sure all are operative and indicate normal readings. Stop engine, first allowing it to cool off for four or five minutes if it is at or beyond normal temperature.

(3) **ITEM 54, FUEL, OIL, AND WATER SUPPLY.** Fill fuel tanks, (see if fuel gage indicates full). Check crankcase oil and add to correct level. Add coolant to correct level. **NOTE: Do not overfill fuel tanks or radiator. Allow room for expansion.** In freezing weather if any appreciable amount of coolant is necessary, have antifreeze value checked and add sufficient to protect cooling system against freezing. Fill all spare fuel and water cans.

(4) **ITEM 57, HORN AND WINDSHIELD WIPERS.** Inspect to see that these items are secure and not damaged. If tactical conditions permit, test horn for proper operation and tone.

(5) **ITEM 58, GLASS AND REAR VISION MIRROR.** Clean and inspect for damage and see that mountings are secure.

(6) **ITEM 59, LAMPS (LIGHTS) AND REFLECTORS.** Inspect for looseness or damage. If tactical situation permits, test all lamps and switches for proper operation. Clean lenses and reflectors.

(7) **ITEM 60, FIRE EXTINGUISHER.** Inspect for looseness or damage and full charge. Remove filler plug to check contents. If extinguisher has been used or valves opened, report for refill or exchange.

(8) **ITEM 61, DECONTAMINATOR.** Inspect for looseness or damage and full charge. Remove filler plug to check contents. If used, report for refill or exchange.

(9) **ITEM 62, *BATTERIES.**

(a) Inspect batteries to see that they are clean, secure and not leaking or damaged. See that cell caps are finger-tight.

(b) *Weekly.* Clean dirt from top of battery. Inspect for bulging or leaks. If terminal connections or post are corroded, clean them

FIRST ECHELON PREVENTIVE MAINTENANCE SERVICE

thoroughly and apply fresh, thin coating of grease. Tighten terminal bolts if loose. Remove vent caps and check level of electrolyte. Add fresh clean water if required to bring electrolyte to proper level (see paragraph 119), take proper precautions during cold weather against freezing. Battery carrier should be secure, clean, free of rust, and well painted. If mountings are loose, tighten them cautiously so as not to damage the battery case.

(10) **ITEM 63, ACCESSORIES AND BELT.** Inspect units such as carbureter, generator, cranking motor, fan, water pump, distributor, regulator unit and oil filter for looseness, damage, or leaks. Check condition and adjustment of generator and water pump drive belt. Adjust, if necessary, to provide $\frac{1}{2}$ inch finger pressure deflection. Investigate and correct or report any deficiencies of accessory units or drive noted during operation.

(11) **ITEM 64, ELECTRICAL WIRING.** Inspect all ignition wiring for looseness, damage, or deterioration of insulation. Wipe off excess grease or moisture, and perform an inspection of all accessible low voltage wiring and connections for looseness or damage. Be sure that all wiring is supported so as not to chafe against other vehicle parts. Examine all radio suppression bond strap, filter, or capacitor bolts and nuts for looseness. Inspect resistor-suppressors at spark plugs and distributor for scorching, looseness or other damage.

(12) **ITEM 65, AIR CLEANERS AND BREATHER CAPS.** Inspect for looseness or damage. Examine oil in reservoirs for correct level and excessive dirt. When operating in sandy or dusty conditions, clean and service air cleaners and breather caps as often as necessary, according to lubrication order. Be sure all gaskets seal properly and that joints and connections are secure.

(13) **ITEM 66, *FUEL FILTER.**

(a) Inspect for looseness, damage and fuel leaks.

(b) *Weekly.* Remove sediment bowl drain plug and drain off all accumulated dirt and water. If draining of fuel pump sediment bowl shows excessive dirt or water, remove and clean element in dry-cleaning solvent and reinstall securely.

(14) **ITEM 67, ENGINE CONTROLS.** Examine all engine operating control linkage for looseness, damage, excessive wear, and adequate lubrication.

(15) **ITEM 68, *TIRES.**

(a) Examine all tires including spares for damage and excessive wear. Remove all embedded foreign matter, such as nails, glass, or stones from treads and carcasses and from between duals. Check for proper position of valve stem and presence of valve caps. Inflate to 55 pounds (maximum) cool.

(b) *Weekly.* Replace badly worn or otherwise unserviceable tires. Serviceable tires which show abnormal wear should be relocated to other wheels to even wear. Apparent mechanical deficiencies causing such wear should be reported for attention by higher echelon.

(16) **ITEM 69, SPRINGS AND SUSPENSIONS.** Inspect all units for looseness or damage. Look for abnormal spring sag, shifted spring

TRUCK, 2½-TON, 6 x 6

leaves, distorted torque rod or loose rod ends, and leaking shock absorbers or rear spring seat bearings.

(17) ITEM 70, STEERING LINKAGE. Inspect all steering components for looseness or damage. Examine steering gear housing and linkage joints for lubricant leakage or lack of lubrication. Investigate any unusual operating conditions noted during operation.

(18) ITEM 71, PROPELLER SHAFTS, CENTER BEARING (PILLOW BLOCK). Inspect all propeller shafts and U-joints for looseness or damage and excessive oil leaks. Remove any foreign material wound around shafts or joints. Examine center bearing (pillow block) for looseness, damage or excessive leaks.

(19) ITEM 72, *AXLE, PILLOW BLOCK, AND TRANSFER VENTS.

(a) See that all axle housing, pillow block, and transfer case vents are present, in good condition and clean. Inspect for indications of lubricant leakage from vents.

(b) *Weekly.* Remove all vents and clean out passages. Reinstall securely.

(20) ITEM 73, LEAKS—GENERAL. Look under vehicle for indications of fuel, engine oil, coolant, brake fluid or gear oil leaks.

(21) ITEM 74, *GEAR OIL LEVELS. (*Weekly*) Check gear oil levels in differentials, transfer case, transmission, winch and steering gear housing, and front axle steering knuckle supports and report if low. Correct levels are from ½ inch below, when cool, to lower edge of filler hole when hot, except winch and steering gear which should be to lower edge of filler hole at all times. If an oil change in any of these units is due, or condition warrants, drain and fill according to lubrication order, Section VIII.

(22) ITEM 76, FENDERS AND BUMPERS. Inspect front fenders, front and rear bumpers, and rear splash guards for looseness or damage.

(23) ITEM 77, TOWING CONNECTIONS. Inspect front tow hooks and rear pintle hook to see that they are in good condition and securely mounted. If in use, be sure they are properly connected, that pintle hook latch is locked and pin is in place.

(24) ITEM 78, BODY, LOAD, AND TARPAULINS (HOIST IF USED). Inspect cab carefully for damage or loose mountings or attachments. Correct or report as necessary. Examine top tarpaulin and end curtains if in use, for worn spots or other damage and see that they are secure. On *cargo bodies*, keep all body mounting bolts tight at all times in order to prevent shifting of body on chassis. Inspect all mountings spaced along body longitudinal sills which will disclose loosened or broken mounting bolts which are easily tightened or replaced. Any cargo must be properly distributed and secure. *Water tank body mountings.* The inspection of body mounting bolts and tightening is performed in the same manner as described for cargo body. See that filler caps and drain cocks are closed and secure. On vehicles equipped with *dump cargo body and hoist*, the body mounting and assembly bolts must be checked and kept tightened at all times. Examine bolts which attach wood rails to top of subframe shackles for looseness. Tighten as necessary. Make certain that body

FIRST ECHELON PREVENTIVE MAINTENANCE SERVICE

hinge bracket bolts are tight and hinge pins are in good condition and well lubricated. Examine packing gland nuts located at hoist pump to pump drive shafts for leaks. Pump manifold and pump valve shaft should be tightened whenever oil leaks are observed. Check oil level in hoist cylinder as directed in lubrication order (Section VIII).

(25) ITEM 79, *WINCH.

(a) Examine winch assembly for looseness or damage and excessive oil leaks at worm gear housing. See that winch drive shaft shear pin is in good condition, lubricated, and secure. Make certain that winch clutch operates freely, is lubricated, and locks securely.

(b) *Weekly.* If vehicle has been operated in deep water, sample lubricant for contamination. If water is present, report condition. If winch cable is dry, dirty, or wound unevenly, unwind entire length, clean, and rewind evenly, after applying oil on cable as directed in paragraph 37, Lubrication. Secure cable chain hook securely to front tow hooks.

(26) ITEM 82, *TIGHTEN.

(a) Tighten any mounting or external assembly nuts or screws where inspection of vehicle has indicated the necessity.

(b) *Weekly.* Tighten wheel mounting and axle flange nuts and cap screws, spring U-bolts, eye bolts, shackles and rebound clips, torque rods, shock links, U-joint companion flanges, body mountings, engine mountings, accessories or special equipment mountings, transfer case mountings, steering arms, towing connections, or any other mountings or external assembly nuts or screws which inspection or experience indicates as necessary on a weekly or mileage basis.

(27) ITEM 83, *LUBRICATE AS NEEDED.

(a) Lubricate all items such as shackles, hinges, latches, control linkage frictional joints, or any point where inspection has indicated oil can or hand greasing is needed.

(b) *Weekly.* Lubricate all points of the vehicle indicated on the lubrication order, Section VIII, as needing lubrication on a weekly or a mileage basis.

(28) ITEM 84, *CLEAN ENGINE AND VEHICLE.

(a) Clean dirt and grease or oil drippings from inside cab, and from engine compartment and exterior of engine. Wipe off excess dirt and grease from entire vehicle.

(b) *Weekly.* Wash vehicle when possible. If not possible, wipe off thoroughly. Inspect paint or camouflage pattern for rust or for bright spots which might cause light reflections. See that vehicle markings are legible unless covered for tactical reasons. **CAUTION: If vehicle is driven into water for washing, care must be taken to see that water or dirt does not get into wheel bearings, gear cases or brakes, or on engine or electrical units or wiring.**

(29) ITEM 85, *TOOLS AND EQUIPMENT.

(a) Check vehicle stowage and tool lists, Section III, to see that all items are present. Inspect items to see that they are in good condition and properly mounted or stowed.

TRUCK, 2½-TON, 6 x 6

(b) *Weekly.* Clean all tools and equipment of rust or dirt and apply a preservative where necessary when possible. See that tools with cutting edge are sharp and properly protected and that all items are securely mounted or stowed.

NOTE: *When services are completed be sure all inspection plates are replaced securely.*

Section XI

SECOND ECHELON PREVENTIVE MAINTENANCE

46. SECOND ECHELON PREVENTIVE MAINTENANCE SERVICES.

a. Regular scheduled maintenance inspections and services are a preventive maintenance function of the using arms, and are the responsibility of commanders of operating organizations.

(1) **FREQUENCY.** The frequency of the preventive maintenance service outlined herein is considered a minimum requirement for normal operation of vehicles. Under unusual operating conditions, such as extreme temperatures, dusty or sandy terrain, it may be necessary to perform certain maintenance services more frequently.

(2) **FIRST ECHELON PARTICIPATION.** The drivers should accompany their vehicles and assist the mechanics, while periodic second echelon preventive maintenance services are performed. Ordinarily, the driver should present the vehicle for a scheduled preventive maintenance service in a reasonably clean condition: that is, it should be dry and not caked with mud or grease, to such an extent that inspection and servicing will be seriously hampered. However, the vehicle should not be washed or wiped thoroughly clean, since certain types of defects, such as cracks, leaks, and loose or shifted parts or assemblies are more evident if the surfaces are slightly soiled or dusty.

(3) If instructions, other than those contained in the general procedures in subparagraph (4) or the specific procedures in subparagraph (5) which follows, are required for the correct performance of a preventive maintenance service, or for correction of a deficiency, other sections of this manual pertaining to the item involved, or a designated individual in authority, should be consulted.

(4) **GENERAL PROCEDURES.** These general procedures are basic instructions which are to be followed when performing the services on the items listed in the specific procedures. **NOTE:** *The second echelon personnel must be thoroughly trained in these procedures, so that they will apply them automatically.*

(a) When new or overhauled subassemblies are installed to correct deficiencies, care should be taken to see that they are clean, correctly installed, properly lubricated and adjusted.

(b) When installing new lubricant retainer seals, a coating of the

SECOND ECHELON PREVENTIVE MAINTENANCE

lubricant should be wiped over the sealing surface of the lip of the seal. When the new seal is a leather seal, it should be soaked in SAE 10 engine oil (warm if practicable) for at least 30 minutes. Then the leather lip should be worked carefully by hand, before installing the seal. The lip must not be scratched or marred.

(c) The general inspection of each item applies also to any supporting member or connection, and usually includes a check to see whether or not the item is in good condition, correctly assembled, secure, or excessively worn. The mechanic must be thoroughly trained in the following explanations of these terms.

1. The inspection for "good condition" is usually an external visual inspection to determine if the unit is damaged beyond safe or serviceable limits. The term good condition is explained further by the following terms: not bent or twisted, not chafed or burned, not broken or cracked, not bare or frayed, not dented or collapsed, not torn or cut.

2. The inspection of a unit to see that it is "correctly assembled" is usually an external visual inspection, to see whether or not it is in its normal assembled position in the vehicle.

3. The inspection of a unit to determine if it is "secure" is usually an external visual examination, a wrench, hand-feel, or a pry-bar check for looseness. Such an inspection should include any brackets, lock washers, lock nuts, locking wires, or cotter pins used in assembly.

4. "Excessively worn" will be understood to mean worn, close-to or beyond serviceable limits, and likely to result in a failure if not replaced before the next scheduled inspection.

(d) *Special Services.* These are indicated by repeating the item numbers in the columns which show the interval at which the services are to be performed, and show that the parts, or assemblies, are to receive certain mandatory services. For example, an item number in one or both columns opposite a TIGHTEN procedure means that the actual tightening of the object must be performed. The special services include:

1. *Adjust.* Make all necessary adjustments in accordance with the pertinent section of this manual.

2. *Clean.* Clean units of the vehicle with dry-cleaning solvent to remove excess lubricant, dirt, and other foreign material. After the parts are cleaned, rinse them in clean fluid and dry them thoroughly. Take care to keep the parts clean, until reassembled, and be certain to keep cleaning fluid away from rubber or other material that it would damage. Clean the protective grease coating from new parts since this material is usually not a good lubricant.

3. *Lubrication.* This applies either to lubrication operations that do not appear on the vehicle lubrication order, or to items that do appear on such orders, but should be performed in connection with the maintenance operations, if parts have been disassembled for inspection or service.

4. *Serve.* This usually consists of performing special operations, such as replenishing battery water, draining and refilling units with oil, and changing or cleaning the oil and fuel filter or cartridge.

TRUCK, 2½-TON, 6 x 6

5. *Tighten.* All tightening operations should be performed with sufficient wrench torque, (force on the wrench handle), to tighten the unit according to good mechanical practice. Use a torque-indicating wrench, where specified. Do not overtighten, as this may strip threads or cause distortion. Tightening will always be understood to include the correct installation of lock washers, lock nuts, and cotter pins provided to secure the tightening.

(e) When conditions make it difficult to perform the complete preventive maintenance procedures at one time, they can sometimes be handled in sections, planning to complete all operations within the week, if possible. All available time at halts and in bivouac areas must be utilized, if necessary to assure that maintenance operations are completed. When limited by the tactical situation, items with Special Services in the columns should be given first consideration.

(f) The numbers of the preventive maintenance procedures that follow are identical with those outlined on W.D., A.G.O. Form No. 461, which is the Preventive Maintenance Service Work Sheet for Wheeled and Half-Track Vehicles. Certain items on the work sheet, that do not apply to this vehicle, are not included in the procedures in this manual. In general, the numerical sequence of items on the work sheet is followed in the manual procedures, but in some instances, there is deviation for conservation of the mechanics time and effort.

(5) **SPECIFIC PROCEDURES.** The procedures for performing each item in the 1000-mile (monthly) and 6000-mile (six-month) maintenance procedures are described in the following chart. Each page of the chart has two columns at its left edge corresponding to the 6000-mile and the 1000-mile maintenance respectively. Very often it will be found that a particular procedure does not apply to both scheduled maintenances. In order to determine which procedure to follow, look down the column corresponding to the maintenance due, and wherever an item number appears perform the operations indicated opposite number.

| 6000 Mile Maint. (six-month) | 1000 Mile Maint. (monthly) |
|------------------------------|----------------------------|
| 1 | 1 |
| 3 | 3 |

ROAD TEST

NOTE: When the tactical situation does not permit a full road test, perform those items which require little or no movement of the vehicle. When a road test is possible, it should be for preferably 5 miles and not over 10 miles.

Before-Operation Service. Perform the Before-Operation Service as described in paragraph 42.

Dash Instruments and Gages.

Oil Pressure Gage. Oil pressure should be 5 pounds at slow idle speed. **CAUTION: Stop engine if oil pressure is not indicated in 30 seconds.**

Ammeter. Indicator may show a positive (+) charge for a short period until generator restores to battery, current used in starting engine. Time will depend on condition of charge of battery and electrical

SECOND ECHELON PREVENTIVE MAINTENANCE

| 6000 Mile Main. (six- month) | 1000 Mile Maint. (month- ly) |
|--|--|
| | |
| 4 | 4 |
| 5 | 5 |
| 6 | 6 |
| 7 | 7 |

load carried. With battery fully charged and when regulator unit is cut-in, ammeter may show zero or only slight charge. Stop engine and investigate any discharge (—) reading with engine running and lights and accessories turned off.

Temperature Gage. Reading should increase gradually during warm-up period to normal range, 160°F to 220°F **CAUTION: Do not move vehicle until engine has reached at least 140°F. Maximum safe operating temperature 220°F (205°F at high altitudes).**

Fuel Gage. Should register amount of fuel in tank.

Speedometer. Speedometer should indicate vehicle speed and odometer should register total accumulating mileage.

Horns, Mirrors, and Windshield Wipers. If tactical situation permits, test horn for proper operation and tone. Examine rear vision mirror and wipers to see that they are in good condition, secure, and that wiper blades contact glass evenly and operate through their full range.

Brakes (Service and Parking, Feel, Side Pull, Noise and Chatter). Operate brakes at various speeds during road test.

Service Brakes. Apply foot pedal sufficiently to stop vehicle in minimum distance and observe effectiveness, any pull to one side, unusual noise, chatter, and pedal travel.

Parking Brake. Stop vehicle on incline, apply parking brake and note if it holds vehicle. Note if lever has sufficient reserve after application and that pawl and sector lock applied brakes securely.

Clutch (Free-travel, Drag, Noise, Chatter, Grab and Slip). Note pedal free-travel (par. 150). Check clutch for drag when shifting into low gear. Note any unusual nose when pedal is depressed which may indicate defective release bearing. With transmission in gear, note any tendency of clutch to chatter, grab when clutch is engaged, or slippage when fully engaged under load.

Transmission and Transfer Case (Lever Action, Declutching, Vibration and Noise). Levers should move into each gear range position easily and quietly. Note any vibration that may indicate loose mounting or noise that may indicate damaged, excessively worn, or inadequately lubricated parts. On winch or hoist

TRUCK, 2 1/2-TON, 6 x 6

| 6000 Mile Maint. (six-month) | 1000 Mile Maint. (monthly) |
|------------------------------|----------------------------|
| 8 | 8 |
| 9 | 9 |
| 10 | 10 |
| 11 | 11 |
| 13 | 13 |
| 14 | 14 |

equipped vehicle, stop vehicle, engage power hoist to see that it also shifts easily and stays in gear when in operation.

Steering (Free Play, Bind, Wander, Shimmy, Side Pull, Column and Wheel). With vehicle in motion, observe whether there is any indication of looseness or binding. Note any tendency to wander, shimmy or pull to one side. See that steering column and wheel are in good condition and secure.

Engine (Idle, Acceleration, Power, Noise and Governed Speed). Observe engine operating characteristics for following conditions:

Unusual Noises. Listen for knocks and rattles as the engine is accelerated, decelerated and while it is under both light and heavy loads.

Acceleration and Power. Operate the engine at varying speeds in all gear ratios, and note if vehicle has normal pulling power and acceleration. Note any tendency to stall while shifting. A slight ping during fast acceleration is normal. Continuing or heavy ping may indicate early timing, or heavy accumulation of carbon.

Governed Speed. With the vehicle in gear, slowly accelerate engine and observe speedometer reading. See if vehicle reaches but does not exceed, the governed speed specified on caution plate.

10 10 Unusual Noises (Attachments, Body, Cab, and Wheels). Listen for any noise that may indicate loose or damaged attachments mounted on vehicle, loose cab or body mountings, floor plates, doors, windshield or accessories. Listen particularly for indications of loose wheel mountings.

11 11 Brake Booster (Hydrovac) Operation. Whenever brakes are applied, observe if the hydrovac unit appears to assist in the application satisfactorily. After stopping vehicle listen at hydrovac air cleaner unit for air movement, when brakes are applied, indicating unit is operating.

13 13 Temperatures (Brake Drums, Hubs, Axles, Transmission, Transfer). Cautiously hand-feel all brake drums and wheel hubs to see if they are abnormally hot. Inspect axle housing, transmission and transfer case for indications of overheating.

14 14 Leaks (Engine Oil, Water, and Fuel). After road test is completed, look under vehicle and in engine compartment, for indications of engine oil, coolant, or lubricant leaks. Trace any leaks found to their source and correct or report them. *NOTE: If tactical conditions permit, remove the engine compartment side panels; disconnect hood bracket, bond*

SECOND ECHELON PREVENTIVE MAINTENANCE

| 6000 Mile Maint. (six- month) | 1000 Mile Maint. (month- ly) | <i>straps, then rest engine hood against the wind- shield. Engine and accessories will then be more accessible to perform maintenance operations.</i> |
|---|--|---|
| 17 | 17 | <p align="center">RAISE VEHICLE AND BLOCK SAFELY</p> <p>Unusual Noises (Engine, Belts, Accessories, Transmission, Transfer, Propeller Shafts and U-joints, Axles and Wheel Bearings). With engine running, observe as follows:</p> <p><i>Engine, Belt and Accessories.</i> Accelerate and decelerate the engine momentarily and listen for any unusual noise in these units that might indicate damaged, loose, or excessively worn engine parts, drive belt or accessories.</p> <p><i>Transmission, Transfer, Propeller Shafts and U-joints, Axles, and Wheel Bearings.</i> With the transmission in an intermediate gear, and front driving axles engaged, operate these units at a constant, moderate speed and observe all propeller shafts and wheels for vibration and runout, and for vibrations in other units which may indicate looseness or unbalance. Slow running wheels may indicate tight brakes or wheel bearings. Also be sure to localize, correct, or report any noise noted during road test.</p> |
| 52 | 52 | <p>Rear Wheels (Bearings, Seals, Drive Flanges, Nuts and Cap Screws). Inspect and service as follows:</p> <p><i>Wheels.</i> Inspect wheels to see that they are in good condition and secure.</p> <p><i>Bearings and Seals.</i> Check for loose wheel bearing adjustment. Revolve wheels and listen for evidence of dry or damaged bearings. Inspect around flanges and brake supports for lubricant leaks.</p> <p><i>Drive Flanges and Nuts or Cap Screws.</i> Note whether they are in good condition and if nuts are tightened securely.</p> |
| 52 | | <p><i>Clean.</i> Disassemble rear wheel bearings and oil seals. Clean thoroughly in solvent and examine bearing cups and cones to see that they are in good condition; if machined surfaces they contact are in good condition and that there is no excessive wear.</p> <p><i>Lubrication.</i> When all of the related items are to the point where the wheel bearings are to be reinstalled, lubricate the bearings (par. 200).</p> <p><i>Adjust.</i> After lubricating the wheel bearings, reassemble the hub-and-drum assemblies into place and adjust the wheel bearings (par. 201 or 202).</p> |
| 48 | | <p>Rear Brakes (Drums, Supports, Cylinders and Cams). Remove rear wheels and drums and inspect and service as follows:</p> <p>On 6000-mile maintenance the several wheel bearing and brake items up to 52 are group services and</p> |

TRUCK, 2 1/2-TON, 6 x 6

| 6000 Mile Maint. (six- month) | 1000 Mile Maint. (month- ly) |
|---|--|
| | |
| 49 | |
| 49 | |
| 49 | 49 |

overlap. Perform in best order for economy of time and orderly reassembly.

Drums and Supports. Clean dirt and grease from drums and supports (dust shields), keeping solvent away from linings. Examine drums and supports to see that they are in good condition, securely mounted and if drums are excessively worn or scored.

Wheel Cylinders. Note condition and mounting of wheel cylinders. Examine cylinder for corrosion and leaks. Make certain that adjusting screws and metal end covers are not corroded and screws frozen. If adjusting screws are rusted, wipe a thin film of water pump or chassis lubricant on screw threads close to end cover, work screw in and out of end cover until it is free. If metal cover and/or adjusting screws are frozen, replace wheel cylinder assembly. If leaks exist at end cover, *do not remove covers*, but replace wheel cylinder assembly.

Cams. Make certain that adjusting pin cams are secure on adjusting pins and that pins work freely. Examine pin springs, brake shoe return springs, articulating links and pins, anchor pins and locks for good condition, secure mountings, and damage.

Tighten. Tighten brake support (dust shield) and anchor plate cap screws and hub to drum nuts securely. Make certain drum mounting on hub is secure.

49 Rear Brake Shoes (Linings, Anchors, and Springs). Examine linings through inspection holes, to see if they are so worn that rivet heads may contact drums within next 1000 miles of operation. If vehicle has been operated in deep water, mud, or loose sand, remove one right rear wheel (brake drum) and examine lining for damage. If this lining must be replaced, remove all wheels and drums, check brakes, and service if necessary (par. 184).

Adjust. Perform brake adjustment if necessary (par. 181). While rear wheels are removed, check linings to see if they are in good condition, tightly secured to brake shoes, in good wearing contact with drums, free of dirt or lubricant and not excessively worn. Also see that shoes are in good condition, properly secured to anchors, guides and retracting springs and that springs have sufficient tension to return shoes properly to released position. Thickness of lining at most worn point should be enough for at least 1000 miles of service before rivet heads are likely to contact drums.

Clean. Clean all dirt and grease from linings with wire brush, cloth or compressed air.

Adjust. After items 48, 49, 52, 54 and 60 are com-

SECOND ECHELON PREVENTIVE MAINTENANCE

| 6000 Mile Maint. (six-month) | 1000 Mile Maint. (month-ly) | |
|------------------------------|-----------------------------|--|
| 60 | 60 | pleted, adjust shoes by method described in paragraph 181. |
| 60 | | Front Wheels (Bearings, Seals, Flanges, Axle End Play and Nuts and Cap Screws). Inspect front wheels, bearings, seals, drive flanges, and nuts and cap screws in same manner as in item 52 for similar rear wheel items. <i>Clean.</i> Disassemble, clean, and inspect the front wheel bearings and oil seals in the same manner as described in item 52, taking care to check the U-joint end play as the drive flanges are removed so that the end play adjustment may be made conveniently. |
| 60 | | <i>Lubrication.</i> Apply in same manner as described in item 52. |
| 60 | | <i>Adjust.</i> Adjust wheel bearings in same manner as described in item 52 and adjust brakes as described in item 49. |
| 53 | 53 | Front Brakes (Hose, Drums, Supports, Cylinders, Cams). Inspect front brake hose and drums externally to see that they are in good condition, that hose is properly supported, securely connected and not chafing or leaking. |
| 53 | | Remove front wheels and inspect and service as follows: |
| | | <i>Drums and Supports.</i> Clean and inspect in same manner as in item 48. |
| | | <i>Cylinders.</i> Inspect in same manner as in item 48. |
| | | <i>Cams.</i> Inspect in same manner as in item 48. |
| 54 | 54 | Front Brake Shoes (Linings, Anchors, and Springs). Inspect in same manner as in item 49. |
| 54 | | <i>Adjust.</i> Adjust by minor method if necessary. |
| | | With front wheels removed, inspect shoes, linings, anchors and springs in same manner as in item 49 for 6000-mile service. |
| 54 | 54 | <i>Clean.</i> Clean in same manner as in item 49. |
| 54 | 54 | <i>Adjust.</i> Adjust in same manner as in item 49 after subsequent related items to 60 inclusive are completed. Refer to paragraphs 181 and 183. |
| 47 | 47 | Tires and Rims (Valve Stems and Caps, Condition, Direction, Matching, Spare Carrier). Inspect as follows: |
| | | <i>Valve Stems and Caps.</i> Observe whether all valve stems are in good condition and in correct position. Replace missing valve caps. <i>Do not tighten with pliers.</i> |
| | | <i>Condition.</i> Examine all tires for cuts, bruises, breaks, and blisters. Remove embedded glass, nails, and stones. Look for irregular tread wear, flat spots, |

TRUCK, 2 1/2-TON, 6 x 6

| 6000 Mile Maint. (six- month) | 1000 Mile Maint. (month- ly) |
|---|--|
| 47 | |
| 50 | 50 |
| 51 | 51 |
| 51 | |
| 51 | |
| 51 | 51 |
| 55 | 55 |

cupping, feather edges, and one-side wear. Remove tires worn thin at center of tread (or other unserviceable tires) and exchange for new or retreaded tires. Any mechanical deficiencies causing such conditions should be determined and corrected or reported. Change wheel positions of tires with irregular wear to even up the wear. Front tires, worn irregularly, should be moved to rear-wheel positions.

Direction. Directional tires and non-directional tires should not be installed on the same vehicle. Directional tires on rear wheels should be mounted so that the "V" of the chevron will point down when viewed from the front. Directional tires on front wheels, ordinarily be mounted so that the "V" of the chevrons will point up when viewed from the front.

Matching. With the tires properly inflated, to 55-pounds (cool), inspect them to see if they are matched according to overall circumference and type of tread (par. 198).

Spare Tire Carriers. See if spare tire carriers are in good condition and secure.

Rims. All rims and their lock rings or flanges should be in good condition and secure.

Tighten. Tighten all wheel rim flange or lug nuts securely.

Serve. With the tires properly inflated, measure the overall circumference of all tires including spares. Select the tires to be mounted on duals or on driving axle, so that they will not have differences in overall circumference exceeding the 3/4-inch specified in current directives and bulletins. Mount all dual tires with the larger tire outside.

NOTE: The spares must be matched properly and mounted for use on one of the road wheels at intervals not exceeding ninety days. A convenient time to do this is during these maintenance services.

Torque Rods. Inspect rods to see that they are in good condition, correctly assembled and secure.

Rear Spring Seats and Bearings. Inspect to see that spring seats are in good condition, secure, and not leaking lubricant.

Adjust. Adjust spring seat bearings as described in paragraph 211 b.

Lubrication. Lubricate spring seat and bearings as described in Section VIII, Lubrication.

Tighten. Tighten spring seat cap screws securely.

LOWER VEHICLE

Steering Knuckles (Joints, Bearings, Seals). Inspect to see that knuckle housings are in good con-

SECOND ECHELON PREVENTIVE MAINTENANCE

| 6000 Mile Maint. (six- month) | 1000 Mile Maint. (month- ly) | |
|---|--|--|
| | | dition. Look particularly for cracks around steering arms. See that outside knuckle felt seals and seal flanges are in good condition and secure. Remove lubrication plug and examine sample of lubricant to see if it appears to be contaminated. |
| 55 | | <i>Clean.</i> Remove constant velocity U-joint assembly. Wash in dry-cleaning solvent and without disassembly of U-joint, inspect parts to see that they are in good condition and not excessively worn. Pay particular attention to U-joint washers, balls and races, axle splines, flanges and pivot bearings. |
| 55 | | <i>Lubrication.</i> Pack new lubricant well into constant velocity U-joint until it fills all space between balls, cages, and races. Reassemble steering knuckle taking care to replace any unserviceable lubricant retainer seals, or gaskets. |
| 55 | | <i>Adjust.</i> Use every precaution to reinstall shims and spacers in the original position from which they were removed at disassembly to insure correct pivot bearing and axle end play adjustment. See paragraph 167. |
| 56 | 56 | Front Springs (Clips, Leaves, U-bolts, Hangers and Shackles). See that they are in good condition, correctly assembled, and secure. Spring clips and bolts should be in place; spring leaves should not be shifted out of their correct position. Note if the deflection of both springs is normal and approximately the same. Test the hangers and bolts for excessive wear by means of a pry bar. |
| 56 | | <i>Tighten.</i> Tighten all spring U-bolts securely and uniformly. |
| 57 | 57 | Steering (Arms, Tie Rod, Drag Link, Pitman Arm, Column and Wheel). Make certain that these items are in good condition, correctly and securely assembled, and mounted. Examine steering gear case for leaks. Test steering assembly mounting for looseness. If evident, adjust steering gear mounting (par. 204). Examine pitman arm for distortion and looseness. |
| 57 | | <i>Tighten.</i> If pitman arm is loose, tighten (par. 205). Examine tie rod, drag link, and steering arms for damage, looseness, and wear. If drag link adjustment is required, adjust (par. 207). Tighten steering arm stud nuts. CAUTION: <i>Loosen the steering column bracket at instrument panel when tightening the steering housing mounting nuts.</i> |
| 58 | 58 | Front Shock Absorbers and Links. See that shock |

TRUCK, 2½-TON, 6 x 6

| 6000 Mile Maint. (six-month) | 1000 Mile Maint. (monthly) |
|------------------------------|----------------------------|
| 58 | |
| 61 | 61 |
| 62 | 62 |
| 62 | |
| 73 | 73 |
| 73 | |
| 74 | 74 |
| 63 | 63 |
| 84 | 84 |

absorber bodies are in good condition, secure to the frame, and not leaking. Make certain that links are not damaged or bent.

Serve. Add shock absorber fluid to shock absorbers as described in paragraph 213.

Front Axle (Seal, Vent and Alinement). (If front axle appears to be out of line, measure distance from front spring eye bolt to center of axle spring pad on each side. Distance should be equal within $\frac{3}{8}$ "). Inspect axle housing to see that it is in good condition and not leaking. Examine pinion shaft seal for leaks.

Clean. Clean axle housing vent thoroughly.

Front Propeller Shaft (Joints, Alinement, Seals and Flanges). See that these items are in good condition, correctly and securely assembled and mounted; that the U-joints are properly alined with each other and are not excessively worn; that the slip joint is free, not excessively worn, and well lubricated, and that the seals on the U-joints and slip joint do not leak.

Tighten. Tighten all U-joint assembly and companion flange bolts securely.

Rear Propeller Shafts. Inspect in same manner as in item 62.

Tighten. Draw up all U-joint and companion flange bolts securely.

Center Bearing (Pillow Block) (Seals and Mountings). Examine pillow block (center bearing) for any excessive end play (par. 177); if evident, replace pillow block assembly. See that it is adequately lubricated and that seals are not leaking, and that the mountings are secure. If leaks exist at seals, replace pillow block assembly. Tighten pillow block mountings securely.

Engine (Mountings, Radio Suppression Bond Straps). They should be in good condition, securely mounted, and connected. Examine both front and rear engine mountings and note if insulators are deteriorating or separating from metal backing. If the mounting bolts are loose, tighten them properly. Take care not to overtighten any rubber insulator type mounting. Remove oil or grease from rubber type mounting.

Exhaust Pipes and Muffler. Examine the exhaust pipe to see that it is securely attached to the exhaust manifold, that the gasket or packing does not show visible evidence of leakage, and that pipe is clamped securely to the muffler. Inspect the muffler to see that it is in good condition and securely mounted. Check

SECOND ECHELON PREVENTIVE MAINTENANCE

| 6000 Mile Maint. (six- month) | 1000 Mile Maint. (month- ly) | |
|---|--|---|
| | | the tail pipe to see that it is securely clamped to the muffler, properly supported, and not clogged. On water tank equipped vehicles, be sure exhaust by-pass valve control mechanism for tank heater box operates easily and properly; that connections, heater box and mountings are all in good condition and secure, and that insulation is intact. |
| 64 | 64 | Hand Brake (Pawl and Sector, Linkage, Drum, and Lining). Examine condition of lining on brake band. Make certain that it is not excessively worn, oil soaked, and that it is in good condition. |
| 64 | | <i>Adjust.</i> Examine band to drum clearance (anchor 0.010-0.015 in., top 0.020 in., bottom 0.020 in.). If excessive, adjust (par. 193). |
| 65 | 65 | Clutch Pedal (Free-travel, Linkage, and Return Spring). Check pedal free-travel (refer to par. 150). Examine and make certain that pedal is securely mounted on shaft, that clutch operating linkage is in good condition, secure, and not excessively worn. See that return spring has proper tension to bring pedal to correct release position. Make certain that return spring bracket is not damaged and is secure. |
| 65 | | <i>Adjust.</i> Set pedal-travel at 2½ inches (par. 150). |
| 66 | 66 | Brake Pedal Free Travel (Linkage and Return Spring). Examine all linkage for condition, make sure that it is secure, and no excessive wear exists at friction points. Be sure return spring has tension to bring pedal to correct release position. Check brake pedal to toe board clearance (½ to 1 inch). If clearance is not correct, adjust as described in paragraph 186. |
| 67 | 67 | Brake Master Cylinder (Fluid Level, Leaks and Switch). Inspect master cylinder to see that it is in good condition; securely mounted and connected; that it does not leak; that boot is properly installed and not damaged, and that stop light switch is securely mounted and connected. |
| 67 | | <i>Serve.</i> Clean top area of master cylinder. Remove filler plug. Examine fluid level of master cylinder. Add fluid to correct level, if necessary. Make certain that vent hole in filler plug is clean. |
| 68 | 68 | Hydrovac (Air Cleaner, Hose, and Cylinder). Inspect for fluid leaks and make certain that unit is securely attached to frame side member. Examine flexible hose connections. Make sure that flexible hose is not cracked or deteriorated. Make certain that hose clamps are secure. If, during road test, Hydrovac operation indicates defective operation, test Hydrovac |

TRUCK, 2½-TON, 6 x 6

| 6000 Mile Maint. (six-month) | 1000 Mile Maint. (monthly) | |
|------------------------------|----------------------------|---|
| 68 | | assembly (par. 179). <i>Clean and Service.</i> Remove Hydrovac air cleaner, Lubrication. <i>Lubrication</i> Lubricate as directed in Section VIII, Lubrication. |
| 68 | 68 | Vacuum Check Valve (Leaks and Deposits). Test vacuum check valve for leaks and examine for damage. Disassemble and clean parts thoroughly, remove scale deposits from valve and valve seat. Examine valve seat in body for pitting and corrosion that may cause an imperfect seat. <i>Slight</i> imperfections may be removed with fine steel wool. <i>Valve Stem.</i> Inspect rubber seal attached to valve stem. Replace with new valve assembly, if deterioration is evident. Inspect the stem and stem guides in cap and body. Stem must be free in guides. Assemble and reinstall, or replace with new assembly. |
| 71 | 71 | Transmission (Mounting, Seals, Power Take-off, Linkage). Observe if transmission case, including power take-off, is in good condition, securely mounted and inspect for lubricant leaks at seals and gaskets. Examine control linkage and shift mechanism for damage or excessive wear. Examine strut rod for looseness. If necessary, adjust according to paragraph 155. |
| 72 | 72 | Transfer (Mountings, Linkage, Seals, Vent). See that case is in good condition, securely mounted, that control linkage, transmission and declutching shift mechanism is securely connected and not damaged. Look for evidence of lubrication leaks at seals and gaskets. Clean vent passage if clogged. Draw up all external assembly and mounting nuts securely. |
| 75 | 75 | Rear Axle (Pinion End Play, Seals, Vent and Alinement). Inspect in the same manner as in item 61 for front axle. <i>Clean.</i> Clean axle housing vent. |
| 77 | 77 | Rear Springs (Clips, Leaves, and U-bolts). Examine spring leaves for damage. Make certain that no leaves are broken or shifted, that spring clips are tight, and that spring is in good condition. Check spring U-bolts and spring seat clamp studs for tightness. Examine springs for sagging condition. Note if deflection of both springs is normal and approximately the same. |
| 79 | 79 | Cab and Body Mountings. Inspect all cab, cargo, tank or dump body mountings to see that they are all present, in good condition and secured. |
| 79 | | <i>Tighten.</i> Tighten cab spring loaded mountings and bond straps. Steering column bracket mountings |

SECOND ECHELON PREVENTIVE MAINTENANCE

| 6000 Mile Maint. (six-month) | 1000 Mile Maint. (monthly) | |
|------------------------------|----------------------------|--|
| 80 | 80 | <p>must be loosened during this operation (par. 221). Tighten all loose cargo, tank or dump body mountings securely.</p> <p>Frame (Side and Crossmembers). Inspect frame, brackets, side members, and crossmembers to see that they are in good condition, secure, and correctly aligned. If the frame appears out of line, check alignment (par. 214), and report condition.</p> |
| 81 | 81 | <p>Wiring, Conduits and Grommets. Observe these items underneath the vehicle to see that they are in good condition, properly supported, connected and secure.</p> |
| 82 | 82 | <p>Fuel Tank, Fittings, and Lines. Inspect fuel tank to see that it is in good condition and securely mounted. Examine fuel tank and lines for leaks. Remove gas tank cap. Make certain that gasket in cap is in good condition, vents are clean, and that valve in cap is free. See that filler neck is in good condition and that cap fits securely.</p> |
| 82 | | <p>Fuel Tank Drain Plug. Remove fuel tank drain plug and drain off accumulated water and dirt in bottom of tank. Drain only until fuel runs clear. Use necessary precautions against fire.</p> |
| 83 | 83 | <p>Brake Lines (Fittings and Hose). Examine all lines, fittings, and hydraulic hose under vehicle to see that they are in good condition, securely connected and supported so lines or hose will not chafe against other vehicle parts. Note if flexible.</p> |
| 25 | 25 | <p>Radiator (Core, Shell, Mountings, Hose, Cap and Gasket, Antifreeze Record, Water Bypass Tube). Inspect all applicable items to see that they are in good condition, secure, and not leaking. Examine condition of coolant to see if it is so contaminated that cooling system should be cleaned. If cleaning of cooling system is necessary, proceed only according to current directives regarding proper procedures, cleaner, neutralizer and inhibitor, paragraph 107. Clean all insects, dirt or grease deposits from core air passages and inspect for bent cooling fins. CAUTION: Use only a suitably shaped piece of wood or blunt instrument to straighten fins. If antifreeze is in use, test its protective value and record in space provided on back of work sheet, Form No. 461.</p> |
| 25 | | <p>Tighten. Tighten all loose radiator mountings, (par. 109), water connections and hose clamps. Give particular attention to bond straps and toothed lock washers.</p> |
| 18 | 18 | <p>Cylinder Head and Gaskets. Remove valve rocker arm cover. Look for cracks or indications of oil,</p> |

TRUCK, 2½-TON, 6 x 6

| 8000 Mile Maint. (six- month) | 1000 Mile Maint. (month- ly) |
|---|--|
| | |
| | 19 |
| 19 | |
| | 20 |
| 20 | |
| | 21 |
| 21 | |
| | 31 |
| 31 | |

coolant, or compression leaks around studs, cap screws, and gaskets.

CAUTION: *Cylinder head bolts should not be tightened unless there is definite evidence of leaks.* Check all bolts with torque wrench. If tightening is necessary, tighten cylinder head bolts in proper sequence (fig. 64, par. 79) to 70 ft-lb torque.

CAUTION: *Always recheck valve stem to rocker clearance after tightening cylinder head bolts.*

Valve Mechanism (Clearance, Lubrication, Cover Gaskets). Adjust valve clearance only if noisy or if engine performance indicates a necessity. Correct clearances are: Intake 0.012, and exhaust 0.016 inch, at operating temperature. Be sure bond strap from valve cover to dash is in good condition and tightly connected.

Adjust. Adjust clearances. Intake 0.012 inch, exhaust 0.016 inch at operating temperature. Examine valve push rods, rocker arms, springs, retainers and keys, to see that they are in good condition, correctly assembled, secure, and that the valve mechanism is receiving adequate lubrication. Replace unserviceable cover gasket.

Spark Plugs (Gaps and Deposits). Remove all plugs and examine for broken insulators, excessive carbon or oxide deposits, and electrodes burned thin. Clean plugs with abrasive type cleaner. Set plug gaps to 0.026 inch by bending only grounded electrodes. **NOTE:** *Do not install plugs until item 21 has been performed.*

Compression Test. Test compression at cranking speed with all spark plugs removed (par. 76 c). Readings in any one engine should be 100 pounds or more. Total variation should not be more than 10 pounds. Record compression pressures in space provided on back of work sheet, Form No. 461.

Distributor (Cap, Rotor, Shaft, Advance Units). Observe whether distributor body and external attachments are in good condition and secure. Examine other parts as follows:

Cap, Rotor, and Points. Remove and clean cap. Inspect cap, rotor, and breaker points, make certain that they are in good condition, secure and clean. Examine closely for cracks in cap and rotor, corrosion of terminals and connections, and burned rotor bar or contact points. See that points are alined and in correct adjustment (0.018 in.) when wide open (par. 88).

SECOND ECHELON PREVENTIVE MAINTENANCE

| 6000 Mile Maint. (six- month) | 1000 Mile Maint. (month- ly) |
|---|--|
| | |
| 32 | 32 |
| 24 | 24 |
| 26 | 26 |
| 26 | |
| 35 | 35 |
| 35 | |
| 34 | 34 |

CAUTION: *Do not remove distributor housings. Before cleaning distributor, remove wick, lubrication cup, condenser, and primary terminal. Replace parts after cleaning distributor.* If breaker points are pitted, burned or worn excessively, replace. If points are burned, replace condenser. When cleaning points, use a fine file, flint paper (2/0), or hone (never use emery cloth) and blow out filings with compressed air.

Shaft. Examine shaft, feeling for excessive wear in shaft or bushings.

Centrifugal Advance. Install rotor on shaft and test distributor governor physically for normal range of movement permitted by mechanism. Note if it returns to original position when released without hang-up or binding.

Lubrication. Lubricate cam surfaces, breaker arm pin, grease cup, and wick (sec. VIII, Lubrication).

Coil and Wiring. Inspect coil and all ignition wiring including shielding or conduits to see that they are in good condition, clean, securely connected and properly mounted. Be sure resistor-suppressors on spark plug and coil to distributor wires are secure and not scorched or damaged. Inspect low voltage wiring in engine compartment in same manner.

Oil Filter and Lines. Inspect filter and external engine oil lines to see that they are in good condition, secure, and not leaking.

Clean and Serve. Remove filter drain plug and drain off any accumulated dirt and sludge. If a filter element change is due or if condition indicates it is necessary, replace element (par. 81).

Water Pump, Fan and Shroud. Inspect pump to see that it is in good condition and that blades and hub are secure. Loosen drive belt and examine fan hub and shaft for bearing wear. See that shroud is in good condition, secure, and alined so as not to interfere with fan blades.

Tighten. Tighten water pump, fan and shroud assembly and mounting nuts.

Crankcase Breather and Filler Cap. Inspect crankcase breather for condition. Remove oil reservoir and element, and service (sec. VIII, Lubrication). Examine filler cap gasket for good condition.

Clean. Disassemble and clean crankcase ventilation valve (par. 82).

Air Cleaner. Inspect carbureter air cleaner to see that

TRUCK, 2 1/2-TON, 6 x 6

| 6000 Mile Maint. (six-month) | 1000 Mile Maint. (monthly) | |
|------------------------------|----------------------------|--|
| 37 | 37 | <p>it is in good condition, securely mounted and connected and not leaking. Remove reservoir and element, clean in solvent, dry, fill reservoir to proper level with new or clean used engine oil and reassemble. Be sure gaskets are in place and all joints and air horn connections tight (par. 99).</p> <p>Fuel Filter and Lines. Examine filter to see that it is in good condition, securely mounted and connected and not leaking. Examine connecting lines for damage and leaks.</p> <p><i>Clean.</i> Close fuel shut-off and remove filter sediment bowl and element. Wash clean in solvent and reassemble (par. 98). Turn on fuel supply and recheck for leaks.</p> |
| 38 | 38 | <p>Fuel Pump. Inspect pump to see that it is in good condition, securely mounted and not leaking. Remove sediment bowl, screen, and clean and reinstall (par. 97). Fuel pump pressure test to be performed after item 40 is completed.</p> |
| 38 | | <p>Check fuel pump pressure (par. 97).</p> |
| 29 | 29 | <p>Drive Belt and Pulleys. Observe generator and fan drive belt for evidence of fraying condition, excessive wear, and deterioration. Inspect all drive pulleys and hubs to see that they are in good condition and securely mounted.</p> <p><i>Adjust.</i> Adjust drive belt to have 1/2-inch finger pressure deflection. See paragraph 108.</p> |
| 33 | 33 | <p>Manifolds and Gaskets. Examine manifold stud nuts for looseness. Carefully tighten manifold stud nuts if necessary, using torque wrench to 15-20 foot-pounds torque. Check heat control valve for proper climatic setting. Examine exhaust pipe flange mounting for looseness. Tighten flange bolts, if necessary. Examine for evidence of cracks in manifolds, usually indicated by carbon streaks, damaged gaskets, or evidence of exhaust leaks exist. Examine manifold for alinement and aline if necessary (par. 78). Tighten flange bolts if necessary.</p> |
| 33 | | <p><i>Tighten.</i> Carefully check and tighten all manifold assembly stud nuts and mounting nuts to 15-20 foot-pounds torque, using a torque wrench.</p> |
| 27 | 27 | <p>Generator, Cranking Motor and Switch. Inspect generator, cranking motor and cranking motor switch to see that they are in good condition, securely mounted, and that wiring connections are clean and secure.</p> |
| 27 | | <p>Examine generator and cranking motor commuta-</p> |

SECOND ECHELON PREVENTIVE MAINTENANCE

| 6000 Mile Maint. (six-month) | 1000 Mile Maint. (monthly) | |
|------------------------------|----------------------------|--|
| | | <p>tors and brushes to see that they are in good condition; free in holders and have sufficient spring tension, and that brush connecting wires are secure and not chafing.</p> <p><i>Clean.</i> Blow out commutator end of generator and cranking motor with compressed air. If commutators are dirty, clean only with flint paper 2/0 placed over end of suitable piece of wood and again blow out with air.</p> <p><i>Tighten.</i> Tighten cranking motor mounting bolts securely. See that radio noise suppression condensers on cranking motor and generator are in good condition and tight.</p> |
| 36 | 36 | <p>Carbureter (Choke, Throttle, Linkage and Governor). See that these units are in good condition, correctly assembled, and securely installed; that the carbureter does not leak; that the control linkage, including the choke and throttle shaft, is not excessively worn; that the choke valve opens fully when the control is in its released position; that the throttle valve opens fully when the accelerator is fully depressed, and that the governor is secure and properly sealed.</p> |
| 23 | 23 | <p>Crankcase (Oil Level): Check crankcase oil level and add as needed. If an oil change is due, or condition of oil indicates the necessity, drain crankcase, clean drain plug, and refill to correct level with fresh specified oil (sec. VIII, Lubrication).</p> |
| 39 | 39 | <p>Cranking Motor (Action, Noise, and Speed). Start engine. Note operation of cranking motor. Check for excessive operation noise and adequate cranking speed. As soon as the engine starts, it is advisable to note whether the oil pressure gage and ammeter readings are satisfactory.</p> |
| 40 | 40 | <p>Leaks (Engine Oil, Fuel and Water). With engine running, check all points of oil, fuel and cooling system for leaks. Examine crankcase, valve cover, timing gear cover, and clutch housing for oil leaks. Trace any leaks found to their source and correct or report them. Stop engine and after 15 minutes time allowed for engine oil to drain back into crankcase, check crankcase for proper oil level and replenish if necessary.</p> |
| 41 | 41 | <p>Ignition Timing (Advance). With the engine running at slow idle and timing light connected, check the ignition timing (par. 87). Also note whether</p> |

TRUCK, 2 1/2-TON, 6 x 6

| 6000 Mile Maint. (six-month) | 1000 Mile Maint. (monthly) | |
|------------------------------|----------------------------|--|
| 41 | | automatic controls advance the timing as engine is accelerated gradually. |
| 42 | 42 | <i>Adjust.</i> Adjust the ignition timing (par. 87). |
| | | Engine and Vacuum Test. |
| | | <i>Engine Idle.</i> Adjust carbureter as described in paragraph 94. |
| | | <i>Vacuum Test.</i> Take manifold reading of engine as described in paragraph 76. |
| 22 | 22 | Battery (Cables, Hold Downs, Carrier, Record Gravity, and Voltage). Inspect battery case for cracks or leaks. Clean battery thoroughly. Inspect cables, terminals, bolts, boxes, and hold downs for condition and looseness. Test specific gravity, voltage (par. 120) and record on W.D. A.G.O. Form No. 461. |
| 22 | | <i>Test.</i> Perform high rate discharge test according to instructions for condition which accompany test instrument and record voltage on W.D. A.G.O. Form No. 461. Cell variation should not be more than 30 percent. Note: Specific gravity must be above 1.225 to make this test. |
| 22 | 22 | <i>Serve.</i> Bring electrolyte to proper level by adding distilled or clean water. Clean battery cable terminals, terminal bolts and nuts, and battery boxes and grease lightly. Inspect bolts for serviceability. Tighten terminals and hold down carefully to avoid damage to battery. |
| 43 | 43 | Regulator Unit (Connections, Voltage, Current, and Cut-out). Inspect regulator unit to see that it is in good condition, securely mounted, and connected and clean. Examine radio noise suppression filters in battery, armature and field circuits, and condensers (4) in light circuit for good condition and tight connections. |
| 43 | | <i>Test.</i> Connect the low-voltage-circuit tester and observe whether the voltage regulator, current regulator, and cut-out control the generator out-put properly. |
| 86 | 86 | Toe-in and Turning Stops. Use toe-in gage to determine whether adjustment on split and banjo type axles is within 1/16-3/16 inch limits. See that wheel turning stops are present, secure, and tack welded. Turn front wheels fully in both directions and see whether turns are limited by stop and if tires clear all parts of vehicle. |
| 87 | 87 | Winch (Clutch, Brake, Drive, Shear Pin, and Cable). Check these items to see if they are in good |

SECOND ECHELON PREVENTIVE MAINTENANCE

| 6000 Mile Maint. (six-month) | 1000 Mile Maint. (monthly) | |
|------------------------------|----------------------------|--|
| | | <p>condition, correctly assembled, and secure. See that clutch moves freely on shaft and latches securely; that drag brake functions properly and is not damaged or excessively worn. Inspect automatic brake to see that lining is secure, not excessively worn, and that spring and adjusting nut is properly assembled. Examine drive shaft universal joints for excessive wear and looseness. Make certain that slip joint is free, not excessively worn, and well lubricated. Make certain that correct shear pin is in place and joint is free on shaft. Remove any obstructions that may have become entangled on drive shaft. Inspect cable for winding on drum, and lubrication. Make certain that cable is attached to tow hooks securely. Check safety collar clearance (par. 24). Clearance is $\frac{1}{2}$ inch.</p> <p><i>Lubrication.</i> Check oil level and condition in worm gear case. Use engine oil. Lubricate the winch clutch, the shaft upon which it slides, and its operating arm. As lubricant is applied, move the clutch back and forth several times to make sure that it is free.</p> <p><i>Clean and Service.</i> Unwind cable and inspect for broken or frayed strands, flat or rusty spots, and kinks. Clean entire length with cloth saturated in thin oil or kerosene. As cable is rewound, apply a coating of clean engine or gear oil evenly; if worm gear housing oil change is due or condition of oil indicates necessity, drain worm gear housing, and fill to correct level with specified oil as described in section VIII, Lubrication.</p> |
| 87 | | |
| 89 | 89 | Tractor to Trailer Wiring Connector. Examine wiring connector to make certain that it is in good condition and not damaged. |
| 93 | 93 | Front Bumper, Tow Hooks, and Brush Guard. See that they are in good condition, secure, and that radiator is not obstructed. NOTE: Reinstall and secure hood side panels, if removed. Attach hood bracket and bond strap. Lower and secure hood. |
| 94 | 94 | Hoods and Fasteners. Inspect engine hood (cover) on cab, to see that it is in good condition, and that fasteners operate properly and hold hood securely. |
| 95 | 95 | Front Fenders and Running Boards. Examine fenders and running boards to see that they are in good condition and securely mounted. |
| 96 | 96 | Cab (Doors, Hardware, Glass, Seats and Trim, Floor Boards, Ventilator, and Map Compartment). Inspect these items to see that they are in good condition and secure; that the ventilator door |

TRUCK, 2 1/2-TON, 6 x 6

| 6000 Mile Maint. (six- month) | 1000 Mile Maint. (month- ly) | |
|---|--|--|
| | | and windshield operate properly, that doors are alined in their openings. Engage the bumpers and strikers and latch properly in closed position (closed type cabs). <i>Open Type Cab.</i> Examine cab tarpaulin top, back curtain, upper and lower side curtain assemblies, for damage. Make certain that straps, locks, tie ropes, are in good condition and not frayed, torn, or damaged and that they are secure. |
| 98 | 98 | Circuit Breakers, Fuses, Junction Blocks. Locate these units in low voltage circuits, and inspect them to see that they are in good condition, clean, and securely connected or mounted. |
| 91 | 91 | Lamps (Lights) (Head, Tail, Body, Stop and Blackout). Operate all switches and note if lamps respond. Include stop and blackout lamps. See that foot switch controls head lamp beams properly and that beams are aimed so as not to blind oncoming traffic. Examine all lights to see that they are in good condition and securely mounted and clean lenses. |
| 91 | | <i>Adjust.</i> Adjust lamp unit beams as described in paragraph 121. |
| 92 | 92 | Safety Reflectors. See that they are all present, in good condition, clean and secure. |
| 100 | 100 | Body (Side Panels, Tail Gate and Chains, Floor, Skid Strips, Sockets, Bows, Tarpaulins, Curtains, Troop Seats, Stowage Compartments, and Water Tank). Examine all applicable items to see that they are in good condition, correctly assembled, and secured. See that any hinges and latches are adequately lubricated, that curtains and tarpaulins are in good condition and properly fastened. On tank equipped vehicles, inspect for looseness, leaks, or damage. See that filler covers and drain plugs and cocks seat properly and lock securely. |
| 103 | 103 | Paint and Markings. Examine the paint of the entire vehicle to see that it is in good condition. Pay particular attention to any bright spots in the finish that might cause glare or reflection. Inspect vehicle markings and identification for legibility, including identification plates and their mountings as furnished. |
| 99 | 99 | Rear Splash Guards. Examine rear splash guards for damage and make certain that they are securely mounted. |
| 101 | 101 | Rear Bumpers and Pintle Hook. Inspect rear bumper for looseness or damage. Examine pintle to see that it is in good condition and securely mounted to frame. Test pintle and latch to see if they operate |

SECOND ECHELON PREVENTIVE MAINTENANCE

| 6000 Mile Maint. (six-month) | 1000 Mile Maint. (monthly) | |
|------------------------------|----------------------------|--|
| 90 | 90 | <p>properly; are adequately lubricated; and if lock pin is present and securely attached by chain. Pay particular attention for broken spring or worn draw bar.</p> <p>Hoist (Mounting, Drive, Controls, Pump, Lines, and Cylinder). Raise the body with the hoist and note whether these items are in good condition, correctly assembled, and secure; whether the hoist, controls or any lift linkage are excessively worn, and if the pump, lines, or cylinder are leaking. Stop the engine with body up and note any tendency of the body to drop. When lowering the body, see that it lowers gully and that the guides aline the body properly with the frame.</p> <p><i>Serve.</i> Fill the hoist cylinders with the specified grade of oil, paragraph 246 or 247, taking care to leave the filler-plug loose until the body has been raised and lowered at least twice; then tighten it securely. While the body is raised, lubricate any grease fittings and apply a few drops of oil to the pin joints of all lifting and pump-control mechanisms.</p> |
| 90 | | <p><i>Tighten.</i> Tighten all hoist mounting and assembly bolts securely. Tighten the piston-rod packing nut and any pump and control valve gland nuts, taking care not to overtighten them, as this may score the shafts and cause leaks.</p> |
| 104 | 104 | <p>Radio Bonding (Suppressors, Filters, Condensers, and Shielding). See that all units not covered in the forgoing specific procedures are in good condition and securely mounted and connected. Be sure all additional noise suppression bond straps and toothed lock washers listed in Section XXIV, are inspected for looseness or damage, and see that contact surfaces are clean. <i>NOTE: If objectionable radio noise from vehicle has been reported, make tests in accordance with Section XXIV.</i> If cleaning and tightening of mountings and connections, and replacement of defective radio noise suppression units does not eliminate the trouble, the radio operator will report the condition to the designated individual in authority.</p> |
| 85 | 85 | <p>Vehicle Lubrication. If due, lubricate in accordance with Lubrication Order, section VIII, using only clean lubricant and omitting items that have had lubrication during this service. Replace damaged or missing lubrication fittings, vents, or plugs.</p> |
| TOOLS AND EQUIPMENT | | |
| 131 | 131 | <p>Tools (Vehicle and Pioneer). Inspect all the standard vehicle and pioneer tools to see that they are all</p> |

TRUCK, 2½-TON, 6 x 6

| 6000 Mile Maint. (six- month) | 1000 Mile Maint. (month- ly) |
|---|--|
| 132 | 132 |
| 133 | 133 |
| 134 | 134 |
| 135 | 135 |
| 136 | 136 |
| 137 | 137 |
| 138 | 138 |
| 139 | 139 |
| 141 | 141 |

present (sec. III, Stowage List), in good condition, clean, and properly stowed or securely mounted. Also examine the tools which have cutting edge to make certain that they are sharp. Any tools mounted on the outside of the vehicle which have bright or polished surfaces should be painted or otherwise treated to prevent rust, glare, or reflection.

Fire Extinguisher. See that fire extinguisher (GM-217169) is in good condition, securely mounted, and fully charged. The charge may be determined by shaking extinguisher. Always make certain that nozzles are free from corrosion. Apply engine oil sparingly at nozzle opening and at handle.

Decontaminator. Note if it is in good condition, securely mounted and fully charged. Make the latter check by removing the filler plug. Solution must be replaced each 90 days.

First Aid Kit (if specified). See that it is in good condition, and that all of its items are present and properly packed. Report any deficiencies immediately.

Publications and Form No. 26. The vehicle and equipment manuals, lubrication order, Standard Form No. 26 (Accident-Report Form), W.D., A.G.O. Form No. 478 (MWO and Major Unit Assembly Replacement Record) must be present, legible, and properly stowed.

Traction Devices (Chains). Examine tire chains to be sure they are in good condition, clean, (if not in use) not excessively worn, protected against rust, and properly mounted or stowed.

Tow (Chains, Cables, Rope, and Snatch Blocks). See that the provided towing devices are in good condition, clean, and properly stowed. Tow chains or cables should be properly protected against rust when not in use. If snatch blocks are furnished, check to see that they operate freely.

Spare Shear Pins. Make certain spare shear pins are present, lubricated to prevent rust, and properly stowed.

Fuel and Water Cans and Brackets. Observe whether they are in good condition, secure; that the caps fit tightly and are secured to the can with a chain; and if the cans are leaking.

Modification (MWO's Completed). Inspect the vehicle to determine whether all Field Service Modi-

SECOND ECHELON PREVENTIVE MAINTENANCE

| 6000 Mile Maint. (six-month) | 1000 Mile Maint. (monthly) |
|------------------------------|----------------------------|
| 142 | 142 |

fication Work Orders have been completed and entered on Form 478. Enter any modifications on major unit assembly replacements made during this service.

Final Road Test. Make a final road test rechecking applicable items (2) to (14) inclusive, and also be sure to recheck the transmission, transfer case, and all driving axles to see that the lubricant is at proper level and not leaking. Confine road test to the minimum distance necessary to make satisfactory observations.

NOTE: Correct or report all deficiencies found during final road test.

Section XII

POWER PLANT TROUBLE SHOOTING AND DIAGNOSIS

47. GENERAL.

a. **Scope.** The information contained in this section includes a compilation of trouble symptoms which might be encountered in the operation of the power plant, together with the possible causes and possible remedies. Only those difficulties which can be detected by the using arm are included. Whenever practical, the trouble shooting procedures are classified according to each section of the manual. In some instances, a symptom indicating trouble in one unit may be caused by difficulty in another unit; therefore, cross references to the related units are made whenever this condition exists.

b. **Diagnosing Causes.** The causes of trouble symptoms or faults in a vehicle of this type may be varied; therefore, a hit-and-miss search would result in a tedious guessing contest. The diagnosis of symptoms is an orderly process of eliminating causes of the symptom. An orderly process means to check the most probable or common cause first.

48. ENGINE.

a. **General.** The procedures which follow list engine general trouble symptoms together with diagnosis and remedial operations. These procedures are divided into three general groups which include the most common engine trouble symptoms.

Engine fails to start

Engine runs but operates improperly

Miscellaneous engine operating faults

b. **Systems of the Engine.** The engine must not be considered as a single unit, but rather as a group of units or systems. These

TRUCK, 2½-TON, 6 x 6

systems, such as the fuel, cooling, electrical, lubrication, valve mechanism, and internal mechanical systems must be taken into consideration when checking the cause of and applying the remedy to common engine troubles.

49. ENGINE FAILS TO START.

a. When engine fails to start, a deficiency in one of two systems is most commonly the cause. The most probable cause is ignition system trouble, with fuel system as the next. One of the quickest methods to determine whether starting trouble is caused by the ignition system or the fuel system, is the spark test.

b. **Spark Test.** Disconnect one wire from spark plug. With ignition switch "ON" and cranking motor cranking engine, hold free end of wire about one-eighth of an inch away from engine block. Note the spark. If there is no spark, the trouble lies in the ignition system. If there is a spark, the trouble will be most commonly found in the fuel system.

c. **No Spark.** The action of the ammeter will further aid in the diagnosis of this condition. Normally the ammeter will show a slight discharge with needle oscillating between two and four amperes. Definite procedures are necessary if engine does not start when ammeter action is normal or abnormal. These procedures follow:

(1) **AMMETER SHOWS NO DISCHARGE (ZERO).** A zero reading on the ammeter, with ignition turned "ON" and cranking motor cranking engine, indicates that no current is flowing in the ignition primary circuit; therefore, the following checks should be made on the units of the primary circuit:

(a) First make sure that the ignition switch is fully turned "ON" and that wiring connections at switch are clean and tight.

(b) Turn on headlights to ascertain that current is flowing through ammeter. If ammeter does not show discharge, turn off headlight switch, then disconnect wire at battery side of ammeter and make flash test to determine if current is flowing to the ammeter. Check and tighten connections in circuit between cranking motor and ignition switch.

(c) Remove distributor cap and check condition of points and point opening. Adjust or replace points as necessary.

(d) Check continuity of circuit through primary wire from ignition switch to coil, then from coil to distributor. If current flows through primary wire from switch to coil, and not from coil to distributor, replace the coil. If current flows through primary wire to distributor, the trouble is in the distributor.

(e) Check continuity of circuit from ammeter to ignition switch, then through ignition switch with switch turned "ON." Replace wiring or switch as necessary.

(2) **AMMETER SHOWS NORMAL DISCHARGE (OSCILLATING BETWEEN TWO AND FOUR AMPERES).** If the ammeter oscillates between two and four amperes discharge with switch turned "ON" and cranking motor cranking engine, the primary circuit is functioning correctly; trace the secondary circuit in the following manner:

POWER PLANT TROUBLE SHOOTING AND DIAGNOSIS

(a) Remove coil to distributor high tension wire from distributor cap. Hold end of wire about three-eighths of an inch from a ground. With cranking motor cranking engine or "rocking" points, note spark. If a hot, snappy spark results, reinsert wire in distributor cap and continue with test. If a weak spark results, replace the condenser in the distributor. If a weak spark persists, replace the coil. If no spark results, check high tension wire from coil to distributor for continuity of circuit. Replace with wire known to be good.

(b) With high tension wire from coil to distributor inserted in distributor cap, remove cap. With cranking motor cranking engine, observe inside of cap for visible current leaks.

(c) Check condition of distributor cap center electrode by holding one end of a high tension wire on electrode and the other end about three-eighths of an inch from a ground. Crank engine with cranking motor. Spark should jump gap from high tension wire to ground. If no spark is produced, replace the cap.

(d) Remove high tension wire from coil to distributor at distributor cap. Hold end of high tension wire about three-eighths of an inch from the rotor. Crank engine and watch for spark. If spark is seen, the rotor is defective and must be replaced.

(e) After determining that secondary current arrives at spark plug wires, test each spark plug wire for continuity of circuit. Replace wires which do not test correctly.

(3) **AMMETER SHOWS CONSTANT NORMAL DISCHARGE (DOES NOT OSCILLATE).** A *constant normal discharge* at the ammeter (two to four amperes), indicates that the primary circuit is not being interrupted. Check in the following sequence.

(a) Disconnect primary wire from coil to distributor at distributor. If ammeter drops to zero, check as explained in (b) through (d) below. If ammeter does not drop to zero, reconnect wire to distributor and disconnect at coil. If ammeter then drops to zero, the wire is defective and must be replaced. If ammeter does not drop to zero, the coil is defective and must be replaced.

(b) Check distributor points and adjust or replace if necessary.

(c) Check insulation on movable point and on distributor primary terminal. Replace points or distributor as necessary.

(d) Disconnect condenser pigtail. Make flash test between pigtail terminal and distributor primary wire terminal. If flash occurs, replace condenser.

(4) **AMMETER SHOWS ABNORMAL DISCHARGE (OVER FOUR AMPERES) WITH IGNITION SWITCH "ON", ZERO WITH SWITCH "OFF."** If the ammeter shows abnormal discharge with ignition switch "ON" and zero with switch "OFF," the trouble lies beyond the ignition switch and ahead of the primary exit at the coil. Make tests in the following sequence:

(a) With ignition switch "ON," disconnect wire at dead side of switch. If ammeter returns to zero, the switch is correct. If ammeter does not return to zero, the switch is defective. Replace with one known to be good. Reconnect wire to switch.

TRUCK, 2½-TON, 6 x 6

(b) With switch known to be functioning properly, disconnect wire at primary entrance of coil. If ammeter returns to zero, check terminal of coil for grounded condition. If the terminal is not grounded, replace the coil. If terminal is grounded, correct grounded condition or replace coil.

(c) If the ammeter still shows abnormal discharge after disconnecting primary wire at coil, replace wire from switch to coil.

(5) **AMMETER SHOWS ABNORMAL DISCHARGE WITH IGNITION SWITCH EITHER "ON" OR "OFF."** If abnormal discharge exists with ignition switch either "ON" or "OFF," the trouble is between the ammeter and ignition switch. Shorts may also exist in lighting circuit (between ammeter and light switch) and in generator circuit. Test in following sequence:

(a) Remove wires from discharge side of ammeter. Ammeter should then return to zero. Touch terminal of light circuit wire to ammeter terminal. If ammeter shows discharge, trace short in wire from ammeter to light switch. If no short is present, generator circuit should be checked. If generator circuit does not cause discharge, the trouble lies either in the ignition switch or in the ammeter to ignition switch wire.

(b) With ammeter to switch wire disconnected at both ends, connect a jumper lead to ammeter terminal and to ignition switch terminal. If discharge still shows, replace ignition switch. If ammeter returns to zero, replace ammeter to ignition switch wire.

d. Weak Spark at Plugs.

(1) This condition may be caused by a weak battery. Check battery and charge or replace as necessary.

(2) Remove distributor cap and check condition of points. Clean up and adjust, or replace if necessary.

(3) Check condition of rotor and cap. Replace cap if electrodes are burned, or rotor if segment is burned. Make sure wires are fully seated in sockets in distributor cap.

(4) Check condenser for short and replace if necessary.

(5) Check all connections in circuit from cranking motor to distributor. Clean and tighten as necessary.

(6) Check condition of high tension wires. Replace if wet or swollen.

(7) If items (1) through (6) do not eliminate trouble, replace ignition coil.

e. Good Spark at Plugs. When engine will not start with good spark at plugs, first determine that the fuel tank is not empty, then proceed as follows:

(1) Remove float level sight plug from carbureter bowl (on engine side).

(2) If no fuel can be seen, remove drain plug from bottom of bowl. If no fuel flows out, make check as itemized in (6) below.

(3) If fuel is level with sight plug hole, failure to start may be caused by flooded combustion chambers due to excessive use of choke, or by fuel not reaching the cylinder due to a dirty carbureter. Check choke mechanism or remove carbureter and clean (par. 94).

POWER PLANT TROUBLE SHOOTING AND DIAGNOSIS

(4) If fuel flows out of sight plug hole, carbureter float needs adjustment (par. 94) or fuel pump pressure is excessive (par. 97).

(5) If fuel does not flow out of sight plug hole, but does flow out of drain plug hole, check fuel pump for operation (par. 97) or check adjustment of carbureter float level (par. 94).

(6) If fuel is not reaching carbureter as in (2), check fuel pump operation; check line between fuel pump and fuel filter, clean fuel filter, check lines between fuel filter and fuel tank.

50. ENGINE RUNS BUT OPERATES IMPROPERLY.

a. Continuous Mis-firing.

(1) The most common cause of this condition is dirty spark plugs. First determine that current is flowing to each plug, then remove plugs and check for dirty electrodes. Clean up and adjust spark gap, or replace plugs as necessary. Dirty plugs are an indication of faulty valve operation, or worn piston rings, allowing oil to enter combustion chamber.

(2) Inspect high tension wires. Replace if wet or if insulation is swollen or deteriorated.

(3) Remove distributor cap and check for burned electrodes or cracks. Replace cap if defective.

(4) Conditions contributing to low compression will also cause mis-firing in one or more cylinders. If remedies given in (1), (2), and (3) do not correct the trouble, check compression of all cylinders and make necessary repairs.

b. Erratic Mis-firing at Idling Speeds.

(1) One of the most common causes of mis-firing at idling speed is incorrect carbureter idling adjustment or incorrect float level adjustment. Make adjustments as required (par. 94), then check operation of choke mechanism. Free up and adjust as necessary (par. 95).

(2) Check ignition system units, starting with spark plugs, until all ignition causes are corrected or eliminated.

(3) Check for vacuum leaks at windshield wiper hose, intake manifold gasket, vacuum lines, and carbureter. Check possibility of water entering cylinder due to a leaking cylinder head gasket.

(4) If the condition still exists after making corrections (1), (2), and (3), check valve clearance and valve mechanism operation, perform engine compression test, and make necessary adjustments and repairs.

c. Mis-firing at High Speeds or Under Full Load. Mis-firing at high speeds or under full load is commonly caused by a weak secondary current in the ignition circuit. Weak valve springs, however, will also cause mis-firing at high speeds.

(1) Remove spark plugs and make sure they are the correct type. Clean up and adjust gap. Make sure that gap is same on all plugs (par. 89).

(2) Remove distributor cap and check point opening and test spring tension (par. 88). Adjust point opening and spring tension or replace points as necessary.

TRUCK, 2½-TON, 6 x 6

(3) A weakened coil caused by shorting out of secondary winding will cause mis-firing. Replace coil with one known to be good. Leaks throughout the high tension wires will also weaken the current and cause mis-firing. Check condition of all high tension wires and replace if necessary. Make sure that sockets in distributor cap are thoroughly cleaned of corrosion and that wires are fully seated.

(4) Check operation of valve springs and replace any that are weak.

d. Backfiring.

(1) As a general rule, backfiring into the muffler indicates too rich a fuel mixture. Backfiring into the carbureter indicates too lean a mixture. Make necessary adjustments at carbureter (par. 94).

(2) Check all fuel lines for restrictions and clean air cleaner. Clean carbureter if necessary.

(3) Sticking valves or weak valve springs will also cause backfiring. Check for and correct these conditions. Make sure cylinder head gasket is in good condition.

(4) Extremely late ignition timing will cause backfiring. Check timing and make necessary adjustments (par. 87).

51. ENGINE MISCELLANEOUS OPERATING FAULTS.

a. Excessive Fuel Consumption. For a diagnosis of causes of excessive fuel consumption, refer to **FUEL SYSTEM** trouble shooting and diagnosis (par. 54).

b. Excessive Oil Consumption.

(1) The first step to be taken when an engine uses an excessive amount of oil is to make a thorough inspection for leaks. Check all oil lines and tighten connections or replace as necessary.

(2) Over speeding the engine will result in excessive oil consumption. Poor driving practices should be corrected.

(3) Worn pistons or piston rings are a common cause of excessive oil consumption. Perform engine compression test and make necessary repairs or report condition to higher authority.

(4) Overheating will cause excessive oil consumption. Refer to **COOLING SYSTEM** trouble shooting and diagnosis (par. 56).

(5) Remove crankcase ventilator valve and clean thoroughly to prevent sticking (par. 82).

(6) Report loose connecting rod or main bearings to higher authority.

c. Lack of Power.

(1) The primary cause of lack of power is poor compression. Perform engine compression test and make necessary correction or report condition to higher authority.

(2) Conditions in the fuel system which contribute to lack of power are covered in **FUEL SYSTEM** trouble shooting and diagnosis (par. 54).

(3) Improper ignition timing will result in a lack of power. Refer to **IGNITION SYSTEM** trouble shooting and diagnosis (par. 53).

POWER PLANT TROUBLE SHOOTING AND DIAGNOSIS

(4) Overheating also results in a lack of power. Refer to COOLING SYSTEM trouble shooting and diagnosis (par. 56).

(5) A clogged exhaust system or bent exhaust pipe or tail pipe will result in a lack of power. Check for these conditions and clean out or replace pipes as necessary.

(6) Dragging brakes or improperly inflated tires simulate a lack of power. Check for these conditions and make necessary corrections.

d. Engine Fails to Develop Maximum Permissible rpm. This condition is usually an indication that the governor is dirty and must be replaced (par. 96).

e. Operating Knocks. Noises in an engine generally termed as "operating knocks" may be caused by (1) overloading the engine, (2) carbon in the combustion chamber, (3) incorrect ignition timing, (4) low octane fuel, and (5) pre-ignition.

(1) **OVERLOADING THE ENGINE.** This noise occurs when an engine is placed under extreme load. Generally the noise is reduced after shifting to a lower transmission gear. This knock may be due to a combination of causes, all of which may be generally remedied by using correct transmission speeds.

(2) **CARBON KNOCKS.** This knocking is caused by accumulation of carbon in combustion chambers and is most noticeable when engine is hot and when engine is accelerated. The remedy is cleaning carbon from cylinder head.

(3) **TIMING KNOCK.** Too early ignition timing may cause a knock that may be mistaken for a carbon knock. The engine may also kick back when starting. Check the ignition timing and make necessary corrections.

(4) **FUEL KNOCK.** A poor grade of gasoline may cause a knock or "ping" similar to a carbon knock. Use a better grade of gasoline or readjust ignition timing (manual advance) to accomplish smooth running with grade of fuel used.

(5) **PRE-IGNITION.** One of the causes of pre-ignition (auto-ignition) is the use of wrong type spark plugs. Make certain that correct plugs are used. Also idle engine for 30 seconds before turning off ignition switch.

f. Mechanical Knocks. In many instances, vehicles are sent to the repair shop for major engine overhaul due to improper diagnosis of mechanical difficulty. Properly diagnosing mechanical knocks will, in many cases, result in correcting the difficulty by minor repairs or adjustments, without necessitating removal of the engine from the vehicle.

(1) Mechanical knocks are noises that result from wear or improper adjustments. These knocks are not always easy to locate accurately as no two engines have exactly the same sound with the same faulty condition. In many instances, causes of mechanical knocks will evidence themselves by other symptoms. Correct diagnosis of mechanical knocks requires experience and practice on the particular type of engine to be serviced.

(2) **DIAGNOSIS OF MECHANICAL KNOCKS.** The first step in analyzing a mechanical knock is to be sure that the noise is in the engine.

TRUCK, 2½-TON, 6 x 6

If the noise can be heard with the vehicle stopped and clutch disengaged, the fault is generally in the engine. The engine should be warmed up to operating temperature. Check to see that all cylinders are firing, then try engine under load to bring out the knock. Eliminate the possible causes such as carbon and valves, then proceed as follows to localize the knocks so that corrections may be made or a proper report made to a higher authority.

(a) *Crankshaft and Bearing Knocks.* Loose bearings are usually indicated by heavy dull knock, more noticeable on acceleration of engine when under load. This knock can generally be located by shorting out cylinders on both sides of loose bearing. End play is usually indicated by intermittent knock which may disappear when slight pressure is put on clutch pedal.

(b) *Piston and Connecting Rod Knocks.* Knock caused by loose connecting rod bearing can be shorted out. Loose piston pin noise generally doubles when cylinder is shorted out. Loose piston or piston "slap" is more noticeable when engine is cold and can be generally shorted out. Broken piston pin or ring noise usually has a sharp clicking sound and cannot be shorted out.

(c) *Camshaft Knocks.* These knocks generally occur at half engine speed. Gear cover should be removed and play in gears and shaft checked by higher echelon.

(d) *Timing Gear Noises.* A "humming" noise may indicate tight gears. Loose gears and other timing gear faults may be indicated by a rattle or knock.

(e) *Valve Mechanism Knocks.* If valve mechanism knocks cannot be eliminated by valve clearance adjustment, report to higher authority.

(f) *Water Pump Knocks.* If knocks definitely point to water pump, remove assembly and replace.

(g) *Other Engine Noises.* Check possible sources of other noises such as loose fan blades, engine mounting, and muffler parts.

52. ENGINE LUBRICATION SYSTEM.

a. **General.** The most common trouble experienced with engine lubrication systems is the result of neglecting to use proper grade of oil or to keep oil to proper level. The use of oil of incorrect viscosity will contribute to several engine troubles, while neglecting to keep crankcase oil to proper level will finally result in a damaged engine. Use the correct grade of oil, keep it to proper level, and change it at regular intervals.

b. **Low Oil Pressure.** Low or no oil pressure is commonly caused by a clogged oil pump screen, broken oil lines, or worn main bearings. If the gage is known to be correct, and proper grade of oil is used, remove oil pan, clean screen, and examine oil pump for worn gears. Check oil lines for breaks or leaks, and make necessary corrections.

c. **Excessive Oil Consumption.** Refer to paragraph 51.

53. IGNITION SYSTEM.

a. **General.** The diagnosis of trouble symptoms in this paragraph are of those which pertain only to the ignition system. Reference

POWER PLANT TROUBLE SHOOTING AND DIAGNOSIS

should be made to ENGINE for a diagnosis of like symptoms. When diagnosing any ignition system trouble, the mechanic should visualize the ignition wiring diagram and keep in mind the fundamental action of the two ignition circuits, *primary* and *secondary*.

b. Engine Mis-fires.

(1) Remove spark plugs and clean and adjust point gap. Replace with new plugs if porcelain is cracked (par. 89).

(2) Remove distributor cap and check condition of points. Adjust point opening or replace points as necessary (par. 88).

(3) Check for other causes such as valves, valve springs, or poor compression and make necessary corrections.

(4) If trouble is still present, check ignition coil and condenser and replace if necessary.

c. Engine Backfires.

(1) Backfiring may be caused by crossed spark plug wires or a cracked distributor cap. Check wires and attach in correct firing order (1-5-3-6-2-4). Inspect distributor cap and replace if damaged.

(2) If trouble is still evident, check for other causes as directed in Fuel System (par. 54).

d. Excessive "Ping" (Detonation) Under Load or at High Speed.

(1) This condition can be caused by improper ignition timing or by using an inferior grade of fuel. Make sure a good grade of fuel is used and make necessary manual advance adjustment (par. 87).

(2) "Ping" or knock caused by pre-ignition cannot be corrected by retarding the spark. Pre-ignition is caused by an overheated spot such as exhaust valve head, carbon deposit, or center electrode of spark plug igniting the fuel charge before the regularly timed spark at the plug. This condition can be corrected by using spark plugs of proper heat range, correcting exhaust valve clearance, or removing cylinder head and cleaning carbon deposits from top of piston and from cylinder head.

e. Engine Overheating or Lack of Power.

(1) This condition is sometimes caused by improper ignition timing. Check timing adjustment and make necessary corrections (par. 87).

(2) If this does not eliminate the trouble, check for other causes such as defective cooling system, poor compression, wrong type oil, etc.

54. FUEL SYSTEM.

a. **General.** Many symptoms which might indicate fuel system trouble are in reality due to faulty ignition or valves. Before making any extensive adjustments or repairs on the fuel system, the ignition system and valve operation should be thoroughly checked.

b. **Excessive Fuel Consumption.** The causes of excessive fuel consumption are listed below in logical sequence.

(1) FUEL LEAKS.

(a) *Fuel Lines.* Inspect all fuel lines for leaks, and check and tighten all connections.

TRUCK, 2½-TON, 6 x 6

(b) *Carbureter*. Fuel leaks at carbureter will be evidenced by the presence of fuel on the outside of the carbureter. Leak could be caused by loose drain plugs or improperly installed channel plugs. Tighten drain plugs or replace carbureter as necessary.

(c) *Fuel Pump*. Check for leaks around fuel pump bowl. Tighten knurled nut at top of bowl. If leak continues, replace gasket between bowl and pump.

(d) *Fuel Filter*. Leakage may occur at fuel filter bowl. Tighten cover bolt at top of filter and tighten drain plug. If leak is still present, replace bowl to cover gasket.

(2) IMPROPER CARBURETER ADJUSTMENT OR CARBURETER CONTROLS STICKING.

(a) Adjust idling mixture and choke controls. Install new return spring on choke control if necessary (par. 95).

(b) Air shutter (choke) not returning to fully open position will cause excessive fuel consumption. Soak carbureter air intake in kerosene to cut corrosion, then free up and lubricate shutter shaft.

(c) Adjust accelerator pump stroke for seasonal operation (par. 94).

(3) VALVE IN FUEL TANK CAP STUCK CLOSED. In extremely hot weather, this condition will cause excessive pressure in the fuel tank, which will result in excessive fuel consumption. Replace the cap if this condition is found.

(4) CARBURETER PARTS WORN. If leaks still exist after making corrections as directed in (1), (2), and (3) above, carbureter parts are worn, necessitating an overhaul of the unit. Replace carbureter with a new or rebuilt unit (par. 94).

c. Engine Idles Too Fast.

(1) Improper throttle adjustment, preventing the throttle plate from returning to closed position will cause engine to idle too fast. Properly adjust hand throttle (par. 95).

(2) Check return spring and replace with new spring if damage is apparent.

(3) Soak carbureter throttle body in kerosene to cut corrosion, then free up and lubricate throttle shaft.

d. Engine Dies When Idling.

(1) This condition is usually caused by improper carbureter idling speed or idling mixture adjustment. Make necessary adjustments (par. 94).

(2) Sticking choke control or crankcase ventilating valve will also cause engine to die. Free up and lubricate choke cable shaft and service crankcase ventilating valve.

(3) If trouble is still present, the idling circuit in the carbureter is clogged. Replace carbureter with a new or rebuilt unit (par. 94).

e. Low Fuel Pressure.

(1) Low fuel pressure is usually indicated when engine falters at high speeds. This condition may be caused by air leaking into the fuel lines. Tighten all fuel line connections and tighten fuel pump and fuel filter covers.

(2) Plugged fuel lines or clogged intake valve in fuel tank cap

POWER PLANT TROUBLE SHOOTING AND DIAGNOSIS

will cause low or no fuel pressure. Clean out or replace lines or cap as necessary.

(3) Test fuel pressure (par. 97).

(4) If low pressure is still evident, the fuel pump diaphragm is broken or the fuel pump valves are leaking. Replace diaphragm or valves as necessary.

(5) If the fuel pump linkage is worn excessively, replace pump (par. 97).

f. Engine Falts on Acceleration.

(1) This condition is usually caused by faulty operation of the carbureter accelerator pump or by dirt in the metering jets. In either case, the carbureter must be replaced with a new or rebuilt unit (par. 94).

(2) Air in the fuel lines will also contribute to this condition. Carefully check all lines for leaks.

g. Overheating or Lack of Power.

(1) Too lean a fuel mixture will cause the engine to overheat. Adjust carbureter (par. 94).

(2) Use of a low octane rating fuel will result in a lack of power. In this case, the ignition timing must be adjusted to compensate for the fuel used. This means that the lower the octane rating of the fuel, the more the spark must be retarded (par. 87).

55. EXHAUST SYSTEM.

a. **Odor of Exhaust Fumes in Cab.** The odor of exhaust fumes in the cab are an indication of leaks in the exhaust system.

(1) Check for blown out muffler and replace if necessary.

(2) Tighten all exhaust pipe connections.

(3) Check for leaking manifold gasket or cracked manifold. Replace gasket or manifold as necessary.

b. **Excessive Combustion Noises.** This condition is caused by a blown out muffler, loose manifold, or a blown manifold gasket. Tighten manifold or replace gasket or muffler as necessary.

56. COOLING SYSTEM.

a. **General.** Since the action of the cooling system controls the operating temperature of the engine, it is logical to assume that the cause of an overheated engine lies in the cooling system; however, late ignition timing or improper or insufficient lubricating oil in the engine crankcase will cause the engine to overheat, even though the cooling system is functioning properly. Check these items before making any extensive tests or repairs on the cooling system.

b. Overheating.

(1) Check for broken or loose fan belt. Replace belt or adjust to proper tension (par. 108).

(2) Check all radiator hose connections; water pump mounting bolts, seal and gasket; thermostat housing bolts and gasket, cylinder head bolts and gasket, and make necessary repairs to correct leakage.

TRUCK, 2 1/2-TON, 6 x 6

(3) Check radiator core for leakage and replace with new core if such a condition is found. Check for clogged air passages through radiator core and clean out if necessary.

(4) Cooling liquid may be escaping through an internal leak such as an internally cracked cylinder or block, or a defective cylinder head gasket. Such leakage would be evidenced by bubbles or foam on the oil dip stick, or by a raised oil level in the crankcase. In this case, report the condition to a higher authority.

(5) An inoperative thermostat will cause engine to overheat. Remove thermostat and test or replace with one known to be good (par. 110).

(6) Air suction or exhaust gas leakage into the system will cause rapid rusting and corrosion of engine parts, and this rust and corrosion will eventually clog the small water passages in the radiator core. In the event the cooling system is clogged, perform flushing operations (par. 107); in the event this does not clean out the system, report to higher authority.

(7) An improperly operating water pump will cause engine to overheat. To determine if the water pump is functioning properly, remove radiator filler cap, run engine at medium speed, and notice the action of the water. Do not confuse action caused by vibration with circulation; there will be a distinct noticeable current if the water pump is operating properly.

c. **Overcooling.** Overcooling is caused by the thermostat being stuck open. This is evidenced by the fact that the engine does not warm up to proper operating temperature. If such a condition exists, remove the thermostat and test or replace with one known to be good (par. 110).

57. STARTING SYSTEM.

a. **General.** If the engine fails to start after repeated and satisfactory operations of the cranking motor, cause of failure cannot be attributed to the starting system, but to other functioning systems of the engine such as the ignition system or fuel system.

b. Cranking Motor Fails to Operate.

(1) The first item to check when the cranking motor fails to operate is the battery. If the battery is run down, recharge or replace (par. 119).

(2) Loose or broken battery or ground cable will cause cranking motor failure. Thoroughly clean terminals and tighten or replace cables as necessary.

(3) Cranking motor switch contact terminal sometimes becomes corroded or burned, preventing a good contact. Check for this condition and replace switch if necessary.

(4) If, after making the above corrections, the cranking motor still fails to operate, it is in need of an overhaul and must be replaced with a new or rebuilt unit (par. 114).

c. Cranking Motor Noisy.

(1) Cranking motor noise may be due to loose mounting. Tighten

POWER PLANT TROUBLE SHOOTING AND DIAGNOSIS

cap screw and stud nut attaching cranking motor to clutch housing.

(2) Lubricate cranking motor.

(3) If still noisy, the cranking motor requires an overhaul and must be replaced with a new or rebuilt unit (par. 114).

d. Slow Cranking Speed.

(1) This condition may be caused by a weak battery or loose cable connections. Check for and correct these conditions.

(2) Perform line voltage tests to determine if there is excessive resistance in circuit and make necessary corrections (par. 120).

(3) If the cranking motor still operates slowly after making the above corrections, it is in need of overhaul and must be replaced with a new or rebuilt unit (par. 114).

58. GENERATING SYSTEM.

a. **General.** Since the generator and regulator functions are directly related, both units must be considered when checking symptoms of failure in the generator circuit. When the ammeter shows an unsatisfactory reading, make sure the ammeter is correct before making any repairs on the generating system.

b. High Charging Rate With Fully Charged Battery.

(1) Check generator to regulator ground wire for damage or loose connections.

(2) Clean and tighten all terminals and connections in generator circuit.

(3) If condition still exists, either the voltage regulator is in need of adjustment, or the generator is in need of an overhaul. In either case, replace with a new or rebuilt unit.

c. Low Battery and Low or No Charging Rate.

(1) Check all wires between generator and regulator for signs of worn insulation or other damage. Clean and tighten all connections.

(2) If this does not correct the trouble, either the generator or regulator, or both, must be replaced with new or rebuilt units.

d. Noisy Generator.

(1) Check and tighten all generator mounting bolts. Check fan belt tension and adjust if necessary (par. 108).

(2) If noise is still present, generator is in need of overhaul and must be replaced with a new or rebuilt unit.

59. CLUTCH.

a. **General.** The clutch is designed for maximum efficiency and long life, and with reasonable care, no operating difficulty should be encountered. Natural wear will occur, however, and must be compensated for.

b. Clutch Slipping.

(1) Improper adjustment (no pedal free-travel) will cause the clutch to slip. Adjust pedal free-travel (par. 150).

(2) If this does not eliminate the condition, it may be due to worn facings, grease on facings, clutch disc hub binding on clutch shaft, or insufficient spring tension. Any of these causes necessitate replacing the clutch assembly (par. 152).

TRUCK, 2½-TON, 6 x 6

c. Clutch Grabbing and Chattering.

(1) This condition may be caused by improperly operating the clutch. If this is the cause, the condition may be eliminated by correcting poor driving practices.

(2) Check and tighten engine mounting bolts. Also inspect and tighten all transmission mounting bolts. See that transmission strut rod is connected and properly adjusted.

(3) If grabbing and chattering condition persists, it may be caused by grease on facings, worn splines on clutch shaft or in disc hub, facing loose on disc, or pressure plate scored or rough. Any of these conditions require replacing the clutch assembly (par. 152). When making replacement, inspect for worn splines on clutch shaft and replace transmission if this condition is found.

d. Rattling.

(1) A rattling sound, appearing to originate in the clutch, may be heard if the clutch pedal pull back spring is disconnected. Connect spring and check for continued rattling.

(2) If rattling continues, it is due to weak pressure plate retracting springs or excessive clearance between driving lugs and cover. In either case, the clutch assembly must be replaced (par. 152).

Section XIII

**POWER TRAIN AND MISCELLANEOUS
TROUBLE SHOOTING AND DIAGNOSIS**

60. GENERAL.

a. Scope. The information contained in this section includes a compilation of trouble symptoms which might be encountered in the power train and miscellaneous units during operation of the vehicle, together with possible causes and possible remedies. Only those difficulties which can be detected by the using arm are included. The trouble shooting procedures are classified according to each section of the manual. In some instances, a symptom indicating trouble in one unit may be caused by difficulty in another unit; therefore, cross references to the related units are made whenever this condition exists.

b. Diagnosing Causes. The diagnosis of symptoms is an orderly process of eliminating causes of the symptom. An orderly process means to check the most probable or common cause first. In the following procedures, each trouble symptom is listed with a diagnosis of causes and possible remedies following in logical sequence.

61. BATTERY AND LIGHTING SYSTEM.

a. General. Reference to wiring diagram (fig. 113 or 114) will show that a single circuit from battery to main light switch is com-

POWER TRAIN AND MISCELLANEOUS TROUBLE SHOOTING

mon to all lamps on the vehicle. At main light switch this single circuit is divided into multiple circuits, each of which is common to two or more lamps (except service stop lamp). These circuits are then taken to various junction points where they are divided into individual circuits, each of which is taken to a single lamp. The return path of each circuit is through ground to battery. Dividing the circuits in this manner provides a convenient and logical method of locating the source of trouble. The use of a voltmeter or trouble lamp, and adhering to the following principles will aid in locating trouble in the lighting system.

(1) Source of trouble common to all lamps will be located in that part of the circuit common to all lamps.

(2) Source of trouble common to two or more—but not all—lamps will be located in that part of the circuit common only to the lamps affected.

(3) Source of trouble at a single lamp will be confined to the individual circuit of the lamp affected.

b. One Lamp Will Not Light. This condition is the result of an open circuit or grounded wire between the lamp ground and the feed wire junction. Open circuit or grounded wire may be caused by a burned out or broken filament; poor ground at lamp; corroded contacts or terminals; broken wire; frayed insulation; grounded or shorted terminals; defective main light switch or stop light switch (stop light only).

c. Two or More Lamps Will Not Light. The cause of this condition will be located between the main light switch and the individual lamp junction. Cause may be defective main light switch; defective individual light switch; loose or corroded terminals; broken wire.

d. All Lamps Will Not Light. The cause of this condition will be located between the point where the battery ground strap attaches to the frame and the main light switch.

(1) The cause may be a discharged battery; corroded battery terminals; corroded or broken battery cable or ground strap. These points can be checked by cranking engine with cranking motor. If cranking speed is normal, trouble lies between the cranking motor and main light switch.

(2) Other causes are loose or corroded terminals; defective main light switch; defective circuit breaker; defective ammeter; short circuit or ground at some point in system which causes the circuit breaker to operate. The only remedy is to methodically check the system until the fault is located and corrected.

(3) A vehicle not in use for some time may possibly have all lamp contacts corroded to the point where lamps are inoperative. A remote possibility of failure is that all filaments may have been broken by shock.

e. Lamps Give Insufficient Light. This condition may be caused by excessive resistance in circuit or by a discharged battery. Check condition of battery, then look for loose or corroded terminals and contacts, and frayed insulation on wires.

TRUCK, 2½-TON, 6 x 6

f. **Frequent Lamp Failure.** Frequent burning out of lamps is the result of high voltage at lamps. This is caused by a defective or improperly adjusted voltage regulator.

g. **Discharged Battery.** A discharged battery may be caused by loose or corroded terminals in any of the electrical circuits. Check for and correct such conditions. Shorted or dry battery cells will also result in a discharged battery. Replenish water or replace battery as necessary (par. 119). Check generator charging rate and replace generator if necessary (par. 117).

h. **Overheated Battery.** This condition is caused by a defective or improperly adjusted voltage regulator. Replace regulator (par. 118).

62. RADIO NOISE SUPPRESSION SYSTEM.

a. **Locate Source of Noise.** To locate the source of radio interference emanating from the vehicle, the use of a radio receiver in the vehicle or in an adjacent vehicle will be required. Noting the type of interference present in the receiver will help determine the cause of the trouble. To determine if the noise is coming from the vehicle itself or from an outside source, drive the vehicle at least 100 feet from other vehicles. Turn engine off and turn radio on. Any noise heard will be from an outside source. Start engine. Any noise heard will come from the vehicle itself.

(1) **ENGINE.** Operate engine with vehicle not in motion and listen for noises in the receiver. If a crackling or clicking noise is present, accelerate the engine and turn ignition switch off with engine running at high speed. If noise stops immediately, the interference is being caused by the *Ignition Circuit* (subpar. b below). If an irregular clicking or chattering continues a few seconds after the ignition is shut off, interference is being caused by the *Generating Circuit* (subpar. c below). If the interference is in the form of a whining or whirring noise which varies with engine speed, turn the ignition off. If the tone of the sound lowers in pitch but continues for a few seconds after the ignition is turned off, it is caused by the *Generator* (subpar. d below).

(2) **VEHICLE.** Operate the vehicle and note whether there is any interference present in the receiver. If clicking or scratching noise is present, stop the vehicle, but leave the engine running. If noise stops when motion of vehicle stops, it may be attributed to faulty *Bonding* (subpar. e below), or loose connections in vehicle *Wiring* (subpar. f below).

b. **Ignition Circuit.** Make sure ignition circuit is functioning properly (par. 53). Improper spark plug gaps, improper ignition system adjustments, or worn parts will affect the suppression system. Clean and tighten all wiring connections. Tighten engine mountings. With engine running, remove and replace spark plug wires from spark plugs one at a time, listening for a lessening of the frequency of clicks in the receiver. If removal of one of the wires reduces or eliminates the interference, the spark plug suppressor is defective and must be replaced.

c. **Generating Circuit.** Check regulator mounting bolts and

POWER TRAIN AND MISCELLANEOUS TROUBLE SHOOTING

tighten if necessary. Internal-external toothed lock washers must be in place between regulator base and cowl to ground regulator. Test filters on cowl and replace if faulty (Sec. XXIV). Test condenser on generator and replace if faulty (Sec. XXIV).

d. Generator. Check and tighten all generator connections and mounting bolts. If noise is still present, replace generator assembly (par. 117).

e. Bonding. Check all bond straps for breaks and loose connections. Replace straps or clean and tighten connections. Internal-external toothed lock washers must be used at all bond strap connections.

f. Wiring. Inspect all wiring for worn, frayed, or otherwise damaged insulation. Replace if defective. Clean and tighten all connections.

63. TRANSMISSION.

a. Excessive Noise.

(1) Noise which seemingly comes from the transmission may be caused by another assembly such as axle, transfer case, propeller shaft universal joint, or clutch; therefore, before replacing the transmission due to noise, make sure that difficulty does not exist elsewhere.

(2) Improper or insufficient lubricant may cause transmission noise. Change or add lubricant as directed in Section VIII.

(3) Transmission noise may be caused by gears or bearings being worn, broken, or loose on shafts. These causes require replacing the transmission with a new or rebuilt unit (pars. 154 and 155).

(4) A noisy condition in the power take-off will reflect through the transmission. Check power take-off mounting nuts and tighten as necessary. Incorrect number of gaskets between power take-off and transmission will cause noise. Install correct number of gaskets (par. 157 or 158). Excessively worn power take-off gears necessitate replacing the power take-off assembly (par. 157 or 158).

b. Hard Shifting.

(1) First check for loose transmission to clutch housing cap screws. Tighten all cap screws firmly.

(2) Hard shifting may be due to improper clutch pedal adjustment, causing the clutch to fail to release. Adjust clutch pedal free travel (par. 150).

(3) If this does not eliminate the condition, it is due to scored shift rods or binding in the control cover assembly. Replace transmission assembly (pars. 154 and 155).

c. Slips Out of Gear. This condition is usually caused by weak or broken shift rod poppet springs, a bent shifting fork, or the gears in the transmission are worn excessively and the transmission assembly must be replaced (pars. 154 and 155).

64. POWER TAKE-OFF.

a. Hard Shifting.

(1) Too heavy lubricant in the transmission will cause the power

TRUCK, 2½-TON, 6 x 6

take-off to shift hard. Drain and refill transmission with correct lubricant (Section VIII).

(2) Burred gear teeth will also cause hard shifting. If this condition is present, replace the power take-off assembly (par. 157 or 158).

b. Power Take-off Noisy. The power take-off is so closely related to the transmission that a noisy condition in the power take-off would only be detected through the transmission. Refer to paragraph 63 for a diagnosis of transmission noises.

65. TRANSFER CASE.

a. Hard Shifting.

(1) Hard shifting may not be due to any difficulty in the transfer case, but due to improper driving practices. Follow driving and shifting procedures as directed in paragraph 16.

(2) Tightness in control linkage due to rust, corrosion, dirt, or need of lubrication will cause hard shifting. Inspect, clean, and lubricate linkage.

b. Slips Out of Gear.

(1) Transfer case will slip out of gear if gears do not fully engage due to improperly adjusted control linkage. Adjust control linkage (par. 160).

(2) A weak or broken shift shaft poppet ball spring will cause transfer case to jump out of gear. This condition requires replacement of transfer case assembly (pars. 161 and 162).

c. Loss of Lubricant. This condition is caused by worn or damaged flange hubs, oil seals, or damaged gaskets. In either case, replace the transfer case assembly (pars. 161 and 162).

66. FRONT AND REAR AXLES.

a. General. An unusual noise is usually the first indication of improper functioning of axle driving parts. Noises which seem to come from the axles may be caused by some other unit such as transmission, transfer case, or tires. Some conditions in the front axle directly affect the steering of the vehicle, and are listed under Steering System (par. 70).

b. Continuous Axle Noise.

(1) This condition may be caused by some difficulty in the axle or by improperly or unevenly worn tires.

(2) To determine if noise is caused by axle or by tires, drive vehicle on soft terrain. If this stops the noise, it is being caused by the tires and not by the axle. Inflate tires to proper pressure or replace as necessary (par. 198).

(3) If noise continues on soft terrain, it is caused by worn or improperly adjusted wheel bearings, worn or improperly adjusted differential gears or bearings, or by insufficient lubricant in the differentials and steering knuckles. Add lubricant, adjust wheel bearings (par. 199), or replace axle assembly (pars. 168 and 169, or 173 and 174).

POWER TRAIN AND MISCELLANEOUS TROUBLE SHOOTING

c. **Axle Noise on Drive Only or on Coast Only.** This condition is an indication that the differential pinion and ring gear are out of adjustment or worn excessively. To correct this condition, replace complete axle assembly (pars. 168 and 169, or 173 and 174).

d. **Excessive Backlash in Axle Driving Parts.**

(1) This condition may be caused by loose axle shaft or drive flange cap screws or stud nuts, worn holes in flanges, or by worn splines on axle shafts. Tighten cap screws or stud nuts, or replace axle shafts as necessary (par. 171 or 172).

(2) If excessive backlash still exists, replace axle assembly (pars. 168 and 169, or 173 and 174).

67. PROPELLER SHAFTS.

a. **Excessive Noise or Vibration.**

(1) Need of lubrication in the universal joints will result in excessive propeller shaft noise. Lubricate all universal joints (Sec. VIII).

(2) If propeller shafts are not assembled with universal joints in the same plane, vibration will result. Check for this condition and if found, disconnect propeller shafts and place universal joints in same plane (par. 176).

(3) Check for loose pillow block mounting cap screws and tighten if necessary.

(4) Worn universal joint bearings or journals, or a sprung propeller shaft will cause vibration and noise. Check for these conditions and replace propeller shaft assembly if necessary (par. 176).

(5) Any mechanical movement has vibration periods, which do not result in noise until they tune in with some other part or unit. In this connection, loose or broken fenders, running boards, body or cab hold-down bolts, etc., should be checked as the source of noise if the above remedies do not correct the condition.

68. SERVICE BRAKE SYSTEM.

a. **Excessive Pedal Pressure and Poor Stop.**

(1) This condition is most commonly caused by normal wear of the brake linings. Correct by adjusting brake shoes (par. 181).

(2) Tighten all connections in vacuum system, and clean or replace Hydrovac air cleaner (par. 188). Inspect vacuum check valve at manifold and replace if not operating properly (par. 190).

(3) Inspect brake shoes and linings. If linings are grease soaked or worn excessively, or if the brake shoes are twisted or sprung, replace brake shoe and lining assemblies (pars. 182, 183, and 184).

(4) Check for obstructed brake lines, and clean or replace lines as necessary.

(5) Check brake pedal and linkage for bent or broken condition, and replace damaged parts.

(6) If the condition still exists after making the above corrections, the trouble lies in the Hydrovac. Replace the Hydrovac assembly (par. 188).

(7) In extremely cold weather, with the wrong type fluid in the system, the fluid will thicken and will not flow freely through the

TRUCK, 2½-TON, 6 x 6

lines and openings. This will cause extreme pedal pressure. Drain and flush system and refill with proper fluid (par. 180).

b. Pedal Goes to Floor Board.

(1) If this condition comes about gradually, it is due to normal wear of the brake linings. Check linings and adjust (par. 181), or replace brake shoe and lining assemblies as necessary (pars. 182, 183, and 184).

(2) If the pedal goes to the floor suddenly, it may be due to a leak in the hydraulic system, or the pedal linkage has become broken or disconnected. Check for broken or leaking lines or connections, especially in the flexible lines. If a leak occurs in the front wheel brake lines, rear brakes can be used by shutting off the shut-off cock inside right-hand frame side rail. Replace lines or tighten connections as necessary, and bleed brake system (par. 180). Check for disconnected or broken pedal linkage; make necessary connections, replacements, and adjustments.

(3) Air trapped in the hydraulic system will sometimes permit the pedal to go to the floor. Bleed the entire brake system (par. 180).

c. Noisy Brakes. This condition is caused by dirty brake linings, excessively worn linings, loose lining rivets, twisted or sprung brake shoes, distorted drums, or broken brake shoe return springs. Replace brake shoe and lining assemblies (pars. 182, 183, and 184), or brake drums (par. 185).

d. Springy, Spongy Pedal Action. Brake shoes needing adjustment due to normal wear, or air in the hydraulic system will cause a springy, spongy pedal action. Check brake shoe adjustment and make necessary corrections (par. 181). If pedal action is still soft, bleed brake system (par. 180).

e. One Brake Drags.

(1) This condition may be caused by an improperly adjusted brake shoe. Check adjustment and make necessary correction (par. 181).

(2) Check brake mechanism for corrosion or binding, or for a weak or broken brake shoe return spring, and replace parts as necessary.

(3) Check wheel bearing adjustment and correct if necessary.

(4) Defective wheel cylinder cups or corroded end caps on cylinder will sometimes prevent brake shoes from returning to released position. Check for these conditions and replace wheel cylinder if necessary (par. 189).

f. All Brakes Drag.

(1) Dirt and corrosion in the brake shoe linkage or wheel cylinders is the most common cause of dragging brakes. Clean and lubricate linkage, or replace wheel cylinders as necessary (par. 189).

(2) Brakes will drag if the bypass part in the master cylinder is restricted. This port may be closed by dirt, by a swollen piston cup, or by the piston not fully returning to the rear of the cylinder due to bent or broken linkage. Make necessary adjustments or replace master cylinder (par. 187).

POWER TRAIN AND MISCELLANEOUS TROUBLE SHOOTING

(3) A defective check valve in the Hydrovac slave cylinder will also cause the brakes to drag. This condition necessitates replacing the Hydrovac (par. 188).

(4) Weak or broken brake shoe return springs will cause brakes to drag, although this condition would rarely occur at all wheels at the same time.

g. Locked Brakes. There are several conditions which may contribute to brakes locking. When one or more of the brakes lock, the following symptoms, causes, and remedies should be studied.

(1) **WHEEL CYLINDER STICKING.** Locking of brakes may be caused by sticking of the wheel cylinder piston, or rusting of the caps on wheel cylinder, preventing the return of the brake shoes after a brake application. This is generally caused by old gummy fluid or corrosion. This usually occurs on one or two brakes at a time, but never on all six brakes unless the vehicle has been stored for some time near salt water. To remedy piston sticking condition, drain all fluid and flush the entire hydraulic system with fresh fluid. Wheel cylinder assemblies which are in rusted condition must be replaced (par. 189).

(2) **DIRT IN BRAKE FLUID.** Dirt in the fluid may enter when refilling the master cylinder during bleeding operations. Extreme cleanliness of the fluid containers during this operation is necessary. This symptom may be diagnosed by removing the vacuum hose from the Hydrovac unit. Brakes should then release as all vacuum will then be depleted. To correct such conditions, replace the Hydrovac unit (par. 188), drain and flush the system, and fill with clean fluid (par. 180).

(3) **DIRTY HYDROVAC AIR CLEANER.** The valve in the Hydrovac relay valve may be stuck in open position due to sand or dust drawn in through the air cleaner. Such symptoms can also be diagnosed by removing the vacuum hose from the Hydrovac unit. To correct such conditions, it is necessary to replace the Hydrovac unit (par. 188). To avoid repeated failures, the Hydrovac air cleaner should be cleaned more often, particularly when the vehicle is operating in dusty areas.

(4) **BRAKE LINKAGE OUT OF ADJUSTMENT.** Locked brakes may be caused by the brake pedal linkage being out of adjustment or the brake pedal return spring weak or broken. In either case, slight pedal movement when driving over rough roads will build up the fluid pressure and apply the brakes. This condition may be diagnosed by opening the bleed screw slightly on one wheel cylinder to release the fluid pressure. Brakes should then return to the released position. If this condition exists, the pedal and linkage adjustments should be made as described in paragraph 181.

69. WHEELS, HUBS, AND TIRES.

a. General. When localizing wheel and tire trouble symptoms, consideration must also be taken of various related systems such as brakes, wheel alignment, and steering gear system. Deficiencies in these systems or units will affect performance of wheels, tires, and hub bearings.

TRUCK, 2½-TON, 6 x 6

b. Excessive or Uneven Tire Wear.

(1) Unequal pressures in the tires will cause uneven tire wear. Inflate all tires to correct pressure (par. 198).

(2) Front wheel misalignment will cause excessive tire wear. Check front wheel alignment and make necessary corrections (par. 164).

(3) Bent wheels or damaged wheel bearings will result in uneven tire wear. Replace wheels or bearings as necessary.

(4) Operating vehicle on a dry, hard surfaced road with front axle engaged will result in excessive wear on the front tires.

c. Hard Steering. This condition may be caused by under-inflated tires, steering gear in need of adjustment or lubrication, front wheels out of alignment, or wheel bearings in need of adjustment. Check these items in the sequence given and make necessary corrections.

d. Wheels Pounding. Hub bearings that are damaged or in need of adjustment will produce a pounding at the wheels. A bent wheel will also cause this condition. Replace or adjust hub bearings (par. 201 or 202), or replace wheel (par. 197), as necessary.

e. Shimmy.

(1) Unevenly worn or unevenly inflated front tires will cause front wheels to shimmy. Replace tires or inflate to correct pressure as necessary (par. 198).

(2) Loose or damaged front hub bearings will also cause this condition. Adjust or replace bearings as necessary (par. 201 or 202).

(3) Any condition contributing to improper front wheel and axle alignment may cause front wheel shimmy. Front axle alignment is affected by loose steering knuckle bearings, front spring leaves broken, spring bolts, shackles, or bushings worn, spring center bolt broken, and a bent axle housing or chassis frame. Check front wheel and axle alignment and make necessary corrections (par. 164). Also check for faulty shock absorbers and replace if necessary (par. 213).

70. STEERING SYSTEM.

a. General. Proper operation of the steering system is closely related to other units in the vehicle. Hence, whenever diagnosing steering difficulties, other allied factors must also be checked. A symptom indicating possible trouble in the steering system may also be evidence of deficiency in other units, that is, front axle alignment, front spring suspension, tire inflation, wheel and tire mounting, wheel bearing adjustment, frame alignment, and brakes.

b. Hard Steering.

(1) If this condition exists on a vehicle just out of the repair shop, the worm bearings, sector gear lash, or drag link ends may be adjusted too tight. Check these adjustments and correct if necessary (par. 204). Other causes listed below will result in this condition after vehicle has been in service for some time.

(2) The most common cause of hard steering is under-inflated tires. Inflate all tires to correct pressure (par. 198).

POWER TRAIN AND MISCELLANEOUS TROUBLE SHOOTING

(3) Lack of lubrication in the steering gear or in the steering knuckle bearings will also cause hard steering. Lubricate as directed in Section VIII.

(4) Inspect drag link and replace if bent (par. 207).

(5) Front wheel and axle misalignment will cause hard steering. Check alinement and make necessary corrections (par. 164).

c. Wander or Lack of Steering Control.

(1) This condition may be caused by loose steering gear mountings, pitman arm loose on pitman shaft, or too much sector gear lash. Check these items and make necessary corrections (par. 205 or 204).

(2) Check for loose drag link ends and adjust or replace drag link as necessary (par. 207).

(3) Check front wheel and axle alinement and make necessary corrections (par. 164).

(4) If the condition still exists, the steering gear parts are worn, necessitating replacement of the steering gear assembly. Report to higher authority.

d. Road Shock Transmitted to Steering Wheel.

(1) If this condition exists on a vehicle immediately upon leaving the repair shop, it is due to the drag link, worm bearings, or sector gear lash being adjusted too tight. Check these adjustments and correct as necessary (par. 204).

(2) When the condition occurs after vehicle has been in service for some time, it may be caused by loose wheel bearings. Adjust wheel bearings (par. 199).

e. Unequal Turning Radius to Right and Left.

(1) On a vehicle just out of the repair shop, this condition would be caused by improperly adjusted steering knuckle stop screws, or by the pitman arm not being properly positioned on the pitman shaft. Remove pitman arm and install correctly (par. 205), or replace axle assembly (pars. 168 and 169).

(2) This condition will come about on a vehicle in service by worn steering knuckle stop screws, or by the drag link becoming bent. Replace drag link (par. 207) or axle assembly (pars. 168 and 169).

f. Vehicle Pulls to One Side.

(1) The most common cause of this condition is unequal tire pressures in the front tires. Inflate all tires to correct pressure (par. 198).

(2) Check for damaged or loose wheel bearings, and replace or adjust as necessary (par. 201 or 202).

(3) One front brake dragging will cause vehicle to pull to one side. Check brake shoe adjustment and correct if necessary (par. 181).

(4) Unequal toe-in will cause the vehicle to pull toward the side having the least toe-in. Check toe-in and make necessary corrections (par. 164).

71. FRONT AND REAR SPRINGS.

a. Hard Riding.

(1) This condition is usually present when the vehicle is overloaded. Refer to nomenclature plate for correct load.

TRUCK, 2½-TON, 6 x 6

(2) Hard riding will also result from insufficient lubrication or frozen shackles. Lubricate shackles or remove and clean or replace as necessary (par. 209).

b. Over Flexible.

(1) The most probable cause of this condition is insufficient fluid in the shock absorbers. Refill shock absorbers to proper level (par. 213).

(2) Examine spring and replace if leaves are broken (par. 209 or 210).

(3) If over flexibility still exists, the shock absorbers are not operating properly and must be replaced (par. 213).

c. Spring Leaf Failure.

(1) Breakage of spring leaves is most commonly caused by overloading the vehicle or by driving at excess speed over rough terrain. Refer to nomenclature plate for correct load, and reduce speed over rough terrain when possible.

(2) Loose rebound clips will cause spring breakage. To prevent this, keep rebound clips tight.

(3) Frozen shackles due to lack of lubrication will also cause springs to break. Remove shackles and clean or replace as necessary. Lubricate as directed in Section VIII.

(4) Grabbing brakes will sometimes cause springs to break. Refer to paragraph 68 for causes and remedies of this condition.

d. Excessive Noise.

(1) Excessive spring noise may be caused by worn shackle bolts or spring eye bolts, or by worn shackle or spring eye bushings. Check for these conditions and replace bolts or springs as necessary (par. 209).

(2) Check for loose spring mounting bolts and tighten as necessary.

(3) Loose or damaged rear spring seat bearings will result in excessive noise. Examine bearings and adjust or replace if necessary (par. 211).

72. WINCH.

a. Winch Fails to Operate When Shifted into Gear.

(1) Winch will not operate if the sliding jaw clutch is disengaged from winch drum. Engage as directed in paragraph 24.

(2) If the winch still fails to operate, and the drive shaft revolves at the rear of the worm shaft housing, the shear pin is sheared off and must be replaced (par. 24).

b. Winch Fails to Hold Load. This condition is caused by the automatic brake lining being excessively worn or in need of adjustment. Adjust brake (par. 236) or replace brake band assembly (par. 237), as necessary.

c. Excessive Heat at Brake Cover. If this condition is present, the automatic brake is adjusted too tight, or the wrong type lining has been installed. Adjust brake (par. 236), or replace brake band assembly (par. 237).

POWER TRAIN AND MISCELLANEOUS TROUBLE SHOOTING

d. **Winch Drum Over-runs Cable When Cable is Being Pulled Off by Hand.** The automatic brake being in need of adjustment is the cause of this trouble. Adjust brake (par. 236).

e. **Noisy Operation.** Noisy operation is usually caused by insufficient lubrication. Add lubricant as directed in Section VIII.

73. POWER HOIST.

a. **Noisy Pump.** Air in the oil is the most common cause of a noisy pump. This may be caused by:

(1) Insufficient oil in cylinder. Add oil as directed in paragraph 246 or 247.

(2) Racing engine while pump is being operated. Run engine at slower speed.

(3) Failure of operator to disengage power take-off after hoist has reached extreme raised position. Move hoist control lever to "HOLD" position, then disengage power take-off.

b. **Hoist Fails to Lift.**

(1) This condition may be caused by insufficient oil in hoist cylinder. Check for oil leaks and make necessary corrections or replace cylinder (par. 246 or 247). If no oil leaks are found, add oil (par. 246 or 247).

(2) Check for sheared drive shaft keys and replace keys as required (par. 245).

(3) Bent or damaged hoist lifting linkage (levers and arms) will cause lifting failure. Damaged parts must be replaced.

(4) Overloading or improper load distribution will cause failure of hoist to lift.

(5) Hoist will not lift if the valve control linkage is improperly installed. Install linkage correctly (par. 244).

74. WATER TANK PUMP.

a. Refer to References in Appendix for TM covering this pump.

Section XIV

ENGINE DESCRIPTION, DATA, MAINTENANCE, AND ADJUSTMENT ON VEHICLE

75. DESCRIPTION AND TABULATED DATA.

a. **Description.** The engine is a six-cylinder, in-line, valve-in-head type, three-point mounted in front of chassis. Engine and accessories are accessible for service after hood is raised. Side panel may also be removed for further accessibility (fig. 57).

TRUCK, 2½-TON, 6 x 6

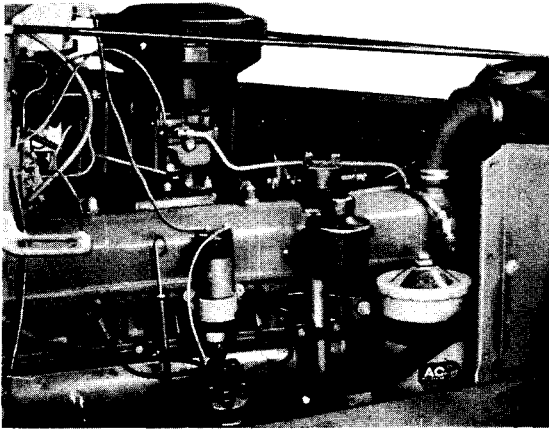

RIGHT SIDE

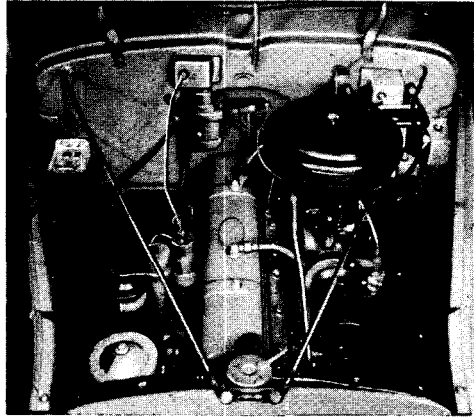

FRONT

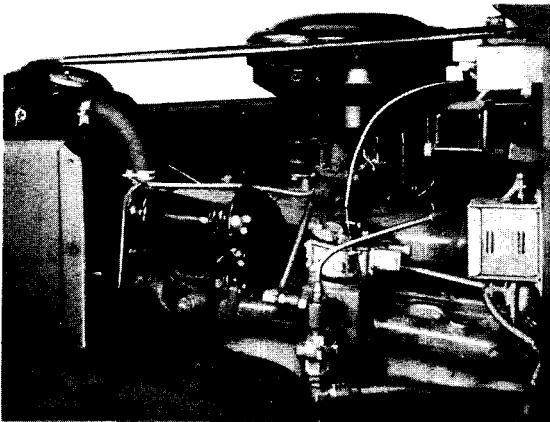

LEFT SIDE

Figure 57—Engine Accessibility

RA PD 333031

**ENGINE DESCRIPTION, DATA, MAINTENANCE, AND
ADJUSTMENT ON VEHICLE**

b. Tabulated Data.

(1) GENERAL.

| | |
|------------------------------|---|
| Engine type..... | 6 cyl.—valve-in-head |
| Bore and stroke..... | 3 $\frac{25}{32}$ x 4 in. |
| Oil pan capacity..... | See Lubrication Order (Section VIII) |
| Cooling system capacity..... | 19 qt |

(2) ADJUSTMENT DATA.

Valve Clearance (hot)

| | |
|--|-----------------|
| Intake..... | 0.012 in. |
| Exhaust..... | 0.016 in. |
| <i>Spark plug gap</i> | 0.025 in. |
| <i>Distributor point opening</i> | 0.018—0.024 in. |

Cylinder Head Bolt Tightening Torque

| | |
|----------------------------|----------|
| Preliminary (par. 79)..... | 35 ft-lb |
| Final (par. 79)..... | 70 ft-lb |

76. TUNE-UP.

a. General. An engine tune-up is an orderly process of checking engine and accessory equipment to determine if they are within original specifications, and to accomplish such adjustments and repairs so that new engine performance is restored. This tune-up procedure can be accomplished at regular intervals or whenever performance of engine indicates need of such operations.

b. Vacuum Reading. Connect a vacuum gage at intake manifold at windshield wiper connection. Make carbureter idling adjustments (par. 94). With engine running at normal idling speed, the vacuum gage should read about 18 to 21 inches and pointer should be steady. An excessively fluctuating needle between 10 and 15 inches may indicate a defective cylinder head gasket or valve. An extremely low reading may indicate a leak in the intake manifold or gasket. Accelerate and decelerate the engine quickly. If the gage indicator fails to drop to approximately 2 inches as the throttle is opened, and then fails to recoil to at least 24 inches as throttle is closed, it may be an indication of diluted oil, poor piston ring sealing, or abnormal restriction in the carbureter, air cleaner, or exhaust. The above readings apply to sea level—there will be approximately a 1-inch drop for each 1,000 feet of altitude.

c. Compression Test. A compression test may also be made, in order to determine the need of internal repair before tune-up procedures are accomplished. This test will indicate condition of pistons, rings, and valve mechanism. Compression pressure depends upon cranking speeds, engine temperature, oil viscosity, compression ratio, and the condition of the engine. Make test in following manner:

(1) Remove all spark plugs. Turn ignition switch "OFF" and pull hand throttle button all the way out. Insert a compression gage in one spark plug hole. Crank engine 10 or 12 turns with cranking

TRUCK, 2½-TON, 6 x 6

motor. Note highest gage reading while engine is being cranked. Take a reading at each cylinder in the same manner.

(2) Analyze the readings. While readings on some engines may be higher than on others due to conditions mentioned in subparagraph b above, the readings in any one engine should be reasonably high (100 lb or more), and all cylinders should show uniform readings within approximately 10 pounds.

(a) Pour a liberal amount of light engine oil through spark plug hole in cylinder having low reading. Allow sufficient time for oil to spread around rings. Take another reading. If compression is appreciably increased on piston so treated piston or rings require replacement. If no change in compression reading is noted, check valve mechanism.

(b) An extremely low reading in two adjacent cylinders may indicate a cylinder head gasket leak.

(c) If compression cannot be corrected with operations allocated to echelon making test, notify higher authority for proper correction.

d. Tune-up Sequence. Drain and refill crankcase, then service oil filter and crankcase vent cleaner. Proceed with following operations in sequence shown.

- (1) Service and adjust spark plugs (par. 89).
- (2) Clean and tighten battery and ignition cables.
- (3) Test and service battery (par. 120).
- (4) Service distributor cap, rotor, and points (par. 88).
- (5) Check ignition timing (par. 87).
- (6) Check and adjust valve clearance (par. 77).
- (7) Service carbureter (par. 94), fuel filter (par. 98), air cleaner (par. 99), fuel pump (par. 97), and fuel lines (par. 100).

77. VALVE CLEARANCE AND ADJUSTMENT.

a. Preliminary. Warm up engine to operating temperature (at least 160° F). Allow engine to run at idling speed while adjustments are made.

b. Remove Valve Rocker Arm Cover. Disconnect crankcase ventilator tube from fitting at the valve rocker arm cover. Remove two valve cover retaining stud nuts, then remove valve cover.

c. Adjust Valve Clearance. With engine hot and idling, insert feeler gage (0.012 in. for intake and 0.016 in. for exhaust) between rocker arm and valve stem at each valve. Using tool similar to that illustrated in figure 58, or a wrench and screw driver, loosen rocker arm ball stud nut, and tighten or loosen stud until proper clearance is obtained. Tighten nut, and recheck clearance.

d. Install Valve Rocker Arm Cover. Check cover mating surface for distortion. Install cover over gasket, then install and tighten stud nuts just snugly. Only a very light pressure is required to prevent leakage if cover and gasket are in good condition. If a leak occurs, do not attempt to correct by excessively tightening nuts. Check gasket [(GM-6107400) G85-01-00777] for particles of dirt, breaks, or mis-location, and replace if necessary. After cover has been installed, connect ventilator tube to fitting on cover.

**ENGINE DESCRIPTION, DATA, MAINTENANCE, AND
ADJUSTMENT ON VEHICLE**

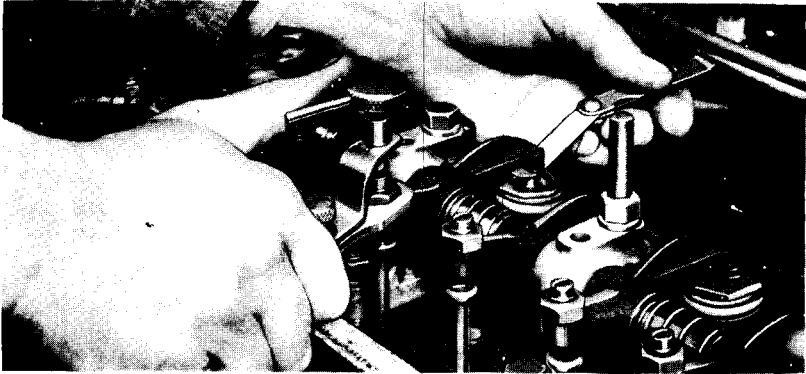

Figure 58—Method of Adjusting Valve Clearance

RA PD 307347

78. INTAKE AND EXHAUST MANIFOLDS.

a. Description. Intake and exhaust manifolds are each one-piece type bolted together to form a complete unit. Unit is mounted to cylinder head, with gaskets and pilot rings between cylinder head and manifolds (fig. 59).

b. Removal.

(1) **PRELIMINARY OPERATIONS.** Remove air cleaner (par. 99) and carbureter and governor (pars. 94 and 96). Disconnect ventilator tube at valve cover and at valve in intake manifold. Unscrew ventilator valve and adapter from intake manifold. Disconnect wiper vacuum line from tee on manifold, then disconnect and remove vacuum check valve. Remove horn from intake manifold. Remove winterization primer connections at manifold if vehicle is so equipped.

(2) **DISCONNECT EXHAUST PIPE.** Remove three bolts from exhaust pipe and manifold flange. Separate flanges and remove gasket.

(3) **REMOVE MANIFOLDS FROM CYLINDER HEAD.** Remove eight manifold to cylinder head stud nuts. Remove four manifold washers and four manifold clamps. Remove two stud nuts and washers at outer ends of exhaust manifold. Pull manifold unit from cylinder head. Remove gaskets and pilot rings.

(4) **SEPARATE MANIFOLDS.** Remove two exhaust to intake manifold cap screws and lock washers. Remove two nuts and lock washers from exhaust to intake manifold studs.

c. Installation.

(1) **INSPECTION.** Inspect manifold for warped condition. Check on surface plate or with straight edge (fig. 60). Variation should not exceed $\frac{1}{32}$ inch. Check clearance between end studs and manifold stud holes. If clearance of approximately $\frac{1}{16}$ inch does not exist, file stud holes to provide necessary clearance before installing manifold. Check condition of exhaust manifold heat control valve. Remove rust, scale, carbon deposits, and any gasket material from face of cylinder head ports. Clean pilot ring seats.

TRUCK, 2½-TON, 6 x 6

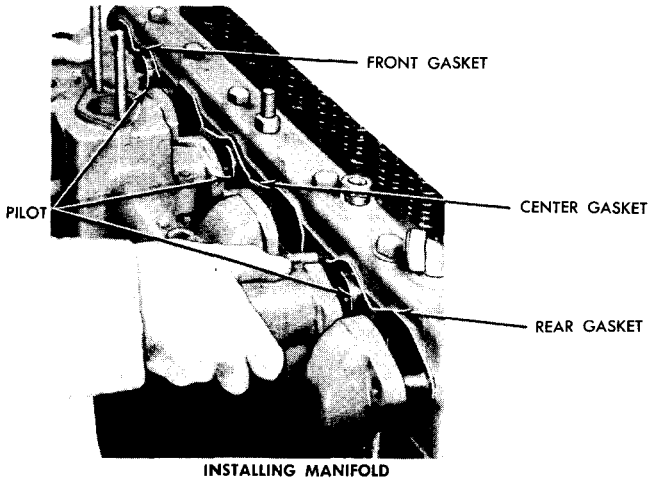
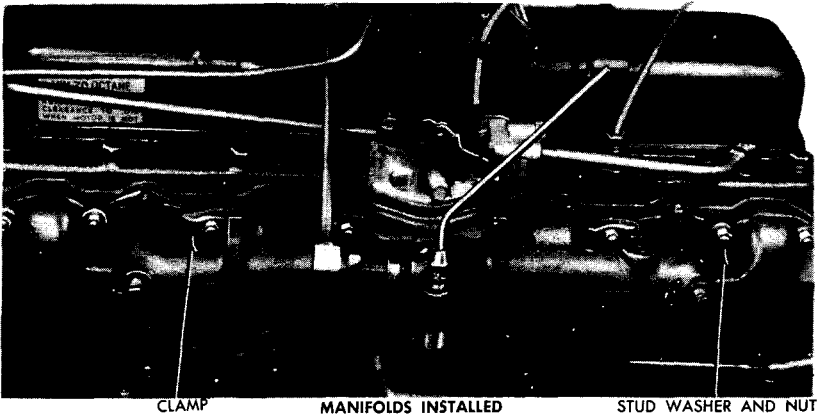

Figure 59—Intake and Exhaust Manifolds Installed

RA PD 332859

(2) **ASSEMBLE MANIFOLDS.** Position exhaust to intake manifold gasket [(GM-838290) G501-30-02340] over intake to exhaust manifold studs. Install two studs, nuts, and lock washers on intake to exhaust manifold studs. Install two cap screws and lock washers. Tighten cap screws and stud nuts only finger-tight.

(3) **INSTALL PILOTS AND MANIFOLD GASKETS.** Position pilots in cylinder head intake ports solidly and not cocked. Install three manifold gaskets—front and rear (GM-6107380), and center (GM-6107381)—on cylinder head manifold studs.

(4) **INSTALL MANIFOLDS.** Position manifold assembly over ends of studs and over pilot rings. Front and rear manifold studs must be centered in exhaust manifold flange holes. Clearance of approximately $\frac{1}{16}$ inch should exist around each stud. Install washers and nuts on

**ENGINE DESCRIPTION, DATA, MAINTENANCE, AND
ADJUSTMENT ON VEHICLE**

these studs. Install four manifold clamps and washers over studs. Install clamp stud nuts, making certain that clamps fit over manifold flanges evenly. Tighten all stud nuts alternately.

(5) **TIGHTEN MANIFOLD ASSEMBLY.** Tighten exhaust to intake manifold cap screws and stud nuts firmly.

(6) **CONNECT EXHAUST PIPE FLANGE.** Insert the three bolts up through exhaust pipe flange and manifold. Make sure that flange seal and gasket (GM-2017499) are in place (par. 103). Install nuts on bolts and tighten firmly and alternately. Install lock nuts.

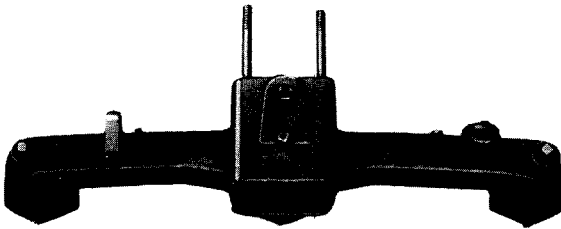

INTAKE

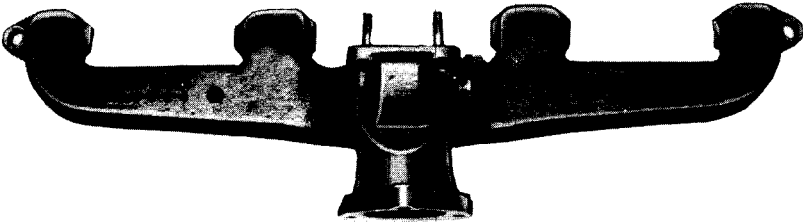

EXHAUST MANIFOLD DISASSEMBLED

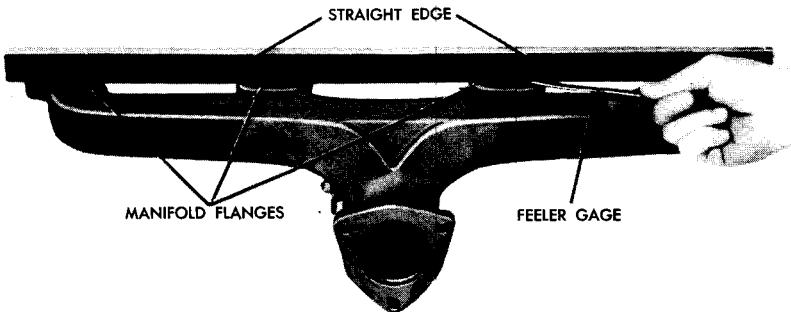

MANIFOLD FLANGES

FEELER GAGE

CHECKING FLANGES

Figure 60—Intake and Exhaust Manifold Inspection RA PD 332918

TRUCK, 2 1/2-TON, 6 x 6

(7) **COMPLETE THE INSTALLATION.** Install ventilator valve and adapter into manifold. Connect ventilator tube at valve and rocker arm cover. Install and connect vacuum check valve, then install wiper vacuum connection to tee. Install carbureter and governor (pars. 94 and 96), then air cleaner (par. 99). Install horn on intake manifold.

(8) **RETIGHTEN.** Run engine through warm-up period, then check tightness of manifold stud nuts.

79. CYLINDER HEAD GASKET REPLACEMENT.**a. Removal.**

(1) **DISCONNECT MANIFOLD.** Remove ventilator tube from valve cover and ventilator valve. Remove air cleaner brace cap screw at cylinder head (when clamp-on type cleaner is used). Disconnect wiper vacuum line at manifold. Disconnect line at vacuum check valve. Disconnect gas line at carbureter, then throttle and choke connections at carbureter. Remove manifold to head stud nuts and clamps. Disconnect manifold at exhaust pipe. Pull manifold, carbureter, and air-cleaner as an assembly from head.

(2) **REMOVE WATER BY-PASS TUBE.** Partially drain cooling system. Disconnect water by-pass tube at rear of cylinder head, and at front at water outlet fitting.

(3) **REMOVE IGNITION COIL, SPARK PLUG WIRES, AND OIL FILTER.** Remove ignition coil (par. 90). Remove wires from spark plugs. Remove oil filter (par. 81).

(4) **DISCONNECT OIL LINE AND THERMAL UNIT.** Disconnect oil line at front of cylinder head. Remove temperature gage thermal unit from cylinder head.

(5) **DISCONNECT WATER OUTLET.** Remove two cap screws which attach thermostat housing to cylinder head. Remove gasket.

(6) **REMOVE VALVE ROCKER ARM AND VALVE PUSH ROD COVERS.** Remove valve rocker arm cover. Remove oil filler tube and bracket; then remove 13 cross-recessed cap screws which attach valve push rod cover to cylinder head and block. Remove push rod cover and gasket.

(7) **REMOVE VALVE ROCKER ARM ASSEMBLY** (fig. 61). Remove 10 cap screws and lock washers which attach rocker arm shaft brackets to head. Remove nuts from the two valve cover studs. Remove overflow tube located on rear bracket. Lift rocker arms, shaft, and brackets from head as an assembly. Lift valve push rods out of engine.

(8) **REMOVE CYLINDER HEAD.** Remove 14 cylinder head to cylinder block cap screws, then air cleaner bracket stud. Lift cylinder head straight up from block.

b. Installation.

(1) **CLEAN CYLINDER HEAD AND BLOCK.** Thoroughly clean gasket surface of cylinder block and head. Remove all dirt and carbon from bolt holes and from cylinder bores.

(2) **POSITION CYLINDER HEAD GASKET.** Place gasket (GM-2136676) carefully on cylinder block with side of gasket marked

**ENGINE DESCRIPTION, DATA, MAINTENANCE, AND
ADJUSTMENT ON VEHICLE**

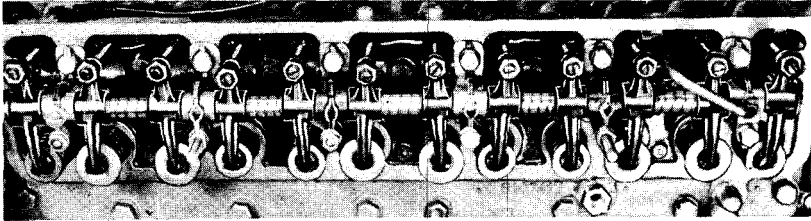

ARRANGEMENT OF ROCKER ARMS

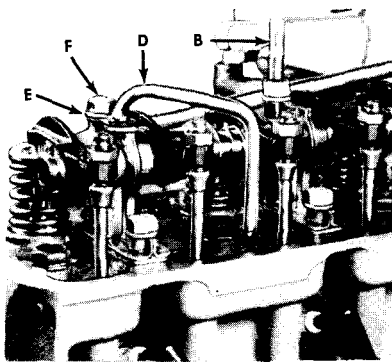

REAR

A LEFT-HAND BRACKET SCREWS
B VALVE COVER STUDS
C RIGHT-HAND BRACKET SCREWS

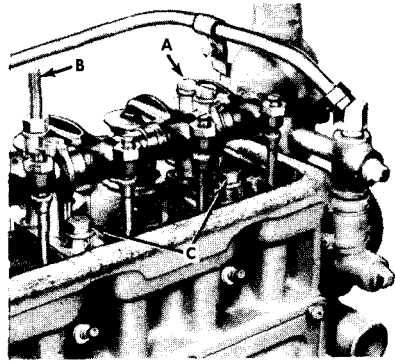

FRONT

D OVERFLOW PIPE
E OVERFLOW PIPE WASHER
F PIPE RETAINING SCREW

RA PD 332957

Figure 61—Valve Rocker Arm Assembly Installed

“TOP” toward cylinder head. This is essential to aline water passage holes in gasket with passages in block and head.

(3) **ALINE GASKET.** Maintaining alinement of cylinder head and gasket with block can be simplified by use of guide pins made from four cylinder head bolts (fig. 62). Insert the guide pins in the four end bolt holes of the block.

(4) **INSTALL CYLINDER HEAD.** Install cylinder head over guide pins, then lower carefully onto block. Insert all cylinder head cap screws except where guide pins are installed. Tighten just finger-tight. Use screw drive to remove guide pins, then install four cap screws in end holes finger-tight.

(5) **PRELIMINARY TIGHTENING.** Cylinder head cap screws must be tightened evenly and in a definite sequence to prevent distortion of head. There are two definite sequences, preliminary and final. Using sequence as shown in figure 63, start at bolt No. 1, and tighten all bolts in sequence shown with a torque wrench to 35 foot-pounds. Final tightening is described in step (7) below.

(6) **INSTALL VALVE ROCKER ARM ASSEMBLY.** Install push rods in place with “cup” end towards top. There are 10 cap screws which attach rocker arm brackets to head. The cap screws on left-hand side

TRUCK, 2½-TON, 6 x 6

are 3¼ inches long, while those on the right-hand side are 1½ inches long. These must be installed in following manner.

(a) Locate rocker arm assembly on head in position shown in figure 61. Make certain that rocker arms are positioned over push rods correctly. Install three 3¼-inch cap screws in bracket from front to rear on left side. Tighten finger-tight. Install the two stud nuts on valve cover studs finger-tight.

(b) Thoroughly coat threads of the six 1½-inch cap screws with joint and thread compound; then install cap screws at right-hand brackets. After all bracket screws are finally tightened, apply a small amount of compound to under side of each tapped hole accessible in spark plug recesses. **NOTE: Use of compound on right-hand bracket cap screws is only necessary on cylinder heads bearing number 2136477, the tapped holes do not extend through the spark plug recesses.**

(c) Install lock washer over end of left rear bracket cap screw, then install overflow pipe retainer clip over end of bolt. Position pipe gasket (GM-6107446) on rear bracket. Install cap screw and overflow pipe on rear bracket. Finally, tighten all bracket cap screws and stud nuts.

(7) **FINAL TIGHTEN CYLINDER HEAD CAP SCREWS.** Using sequence as shown in figure 64, tighten all cap screws to 70 foot-pounds.

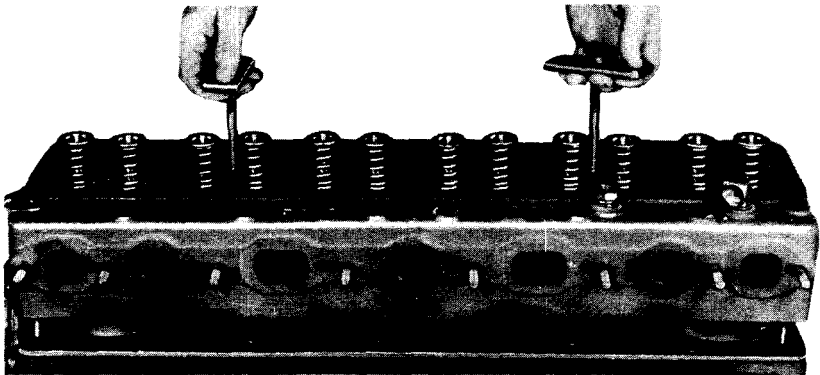

INSTALLING OR REMOVING CYLINDER HEAD

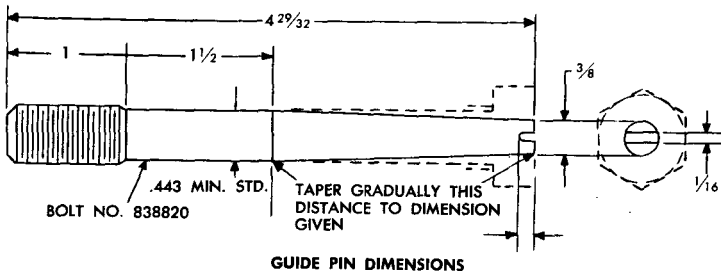

RA PD 332988

Figure 62—Installing or Removing Cylinder Head

**ENGINE DESCRIPTION, DATA, MAINTENANCE, AND
ADJUSTMENT ON VEHICLE**

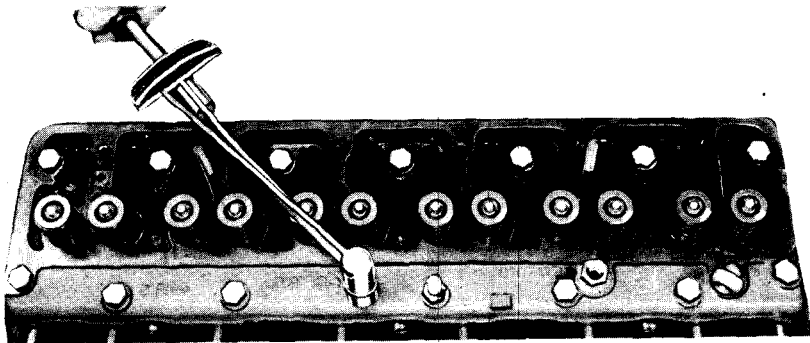

PRELIMINARY TIGHTENING WITH TORQUE WRENCH

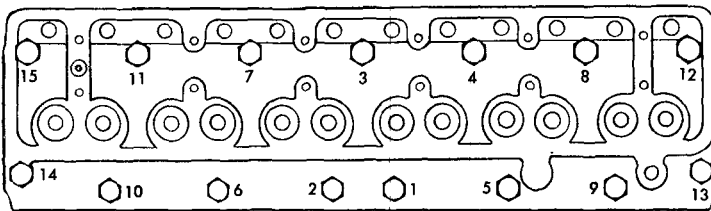

SEQUENCE OF TIGHTENING

RA PD 332955

**Figure 63—Preliminary Tightening Using Torque
Wrench (41-W-3630)**

Use special socket wrench (41-W-2964-700) with torque wrench (41-W-3630). Tighten cap screws on right side first in sequence shown, then tighten cap screws on left side. An additional check of cap screws must be made after engine has been warmed up.

(8) **INSTALL PUSH ROD COVER.** Install cover and gasket (GM-2135926) to block. Install oil filler tube and bracket, attach indicator tube bracket to block.

(9) **COMPLETE THE INSTALLATION.**

(a) Install oil filter (par. 81).

(b) Install thermal unit in head—tighten firmly.

(c) Install spark plug wires in correct sequence (par. 88).

(d) Connect oil line at front of head.

(e) Install ignition coil (par. 90).

(f) Connect manifolds to head and exhaust pipe (par. 78).

(g) Make throttle and choke connections at carbureter. Connect gas line to carbureter. Connect vacuum line to check valve connection. Connect wiper line. If used, install air cleaner brace to stud on head.

(h) Install thermostat housing to head. Use new gasket if necessary [(GM-838297) G85-31-06280].

(i) Install water by-pass tube at rear of head, then at by-pass fitting.

(10) **WARM UP ENGINE.** Fill cooling system—adjust valve clear-

TRUCK, 2 1/2-TON, 6 x 6

ance to 0.012 inch intake and 0.016 inch exhaust (par. 77). Start engine and warm up to at least 160° F.

(11) **RETIGHTEN CYLINDER HEAD CAP SCREWS.** After engine has warmed up, check tightness of cylinder head cap screws (70 ft-lb) following sequence shown in figure 64. Recheck valve clearance and install valve cover. Install ventilator tube to cover and to ventilator valve.

80. OIL PAN.

a. **Description.** The deep sump oil pan assembly comprises an oil pan, sump-like cover, and an oil cleaner through which the oil is circulated. The oil cleaner extends into the cover, however, it is attached to the oil pan. Do not attempt to remove oil pan and cover as an assembly. Such an attempt will damage cleaner.

b. **Draining Pan** (fig. 65). Remove drain plug assembly. Thoroughly clean screen and deflector before reinstalling. Check condition of plug gasket (GM-2137876).

c. **Oil Pan Cover Gasket Replacement.** Remove drain plug assembly. Remove cover attaching screws (fig. 66). Cover may then be lowered and gasket (GM-2137800) replaced.

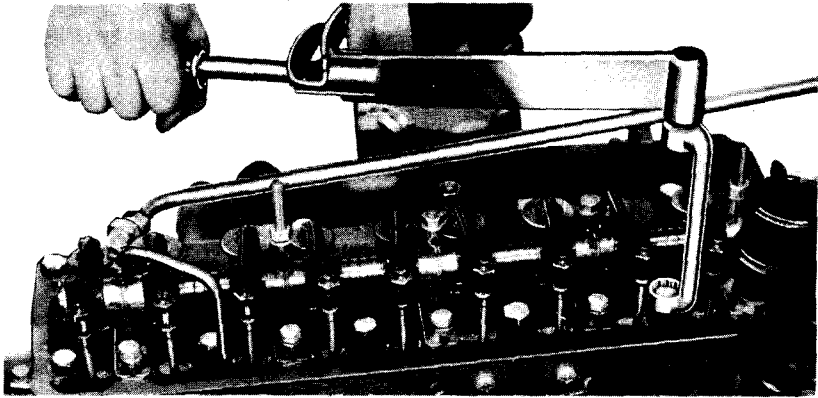

FINAL TIGHTENING WITH TORQUE WRENCH AND SPECIAL SOCKET

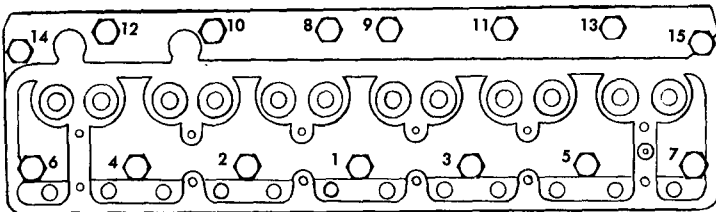

SEQUENCE

**Figure 64—Final Tightening (Torque Wrench 41-W-3630
With Socket Wrench 41-W-2964-700)**

RA PD 332946

**ENGINE DESCRIPTION, DATA, MAINTENANCE, AND
ADJUSTMENT ON VEHICLE**

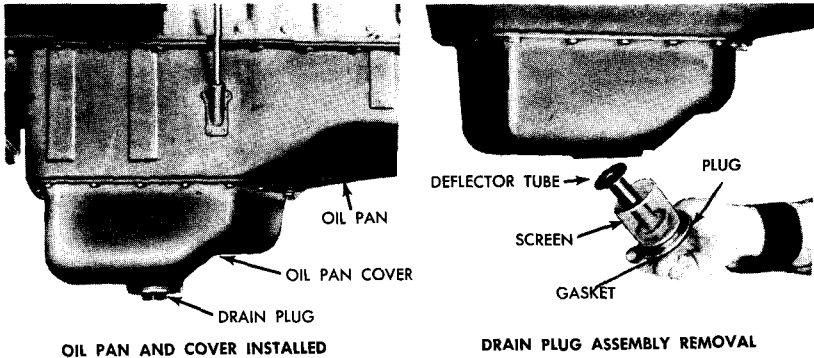

RA PD 332926

Figure 65—Oil Pan, Cover, and Drain Plug Installed

d. Oil Pan Removal.

(1) **REMOVE COVER AND DISCONNECT CLEANER.** Remove oil pan cover. Disconnect oil cleaner outlet connection from pump inlet (fig. 65). *Do not remove the oil cleaner from oil pan. The cleaner and oil pan must be removed as an assembly.*

(2) **REMOVE UNDERPAN AND EXTENSION.** Remove four cross-recessed screws which attach underpan to flywheel housing. Remove two cross-recessed screws which attach extension to housing.

(3) **REMOVE OIL PAN AND CLEANER.** Remove oil level indicator tube at pan. Loosen oil pan attaching screws alternately. Remove screws in same manner while supporting pan. Lower pan together with cleaner carefully.

e. Oil Pan Installation.

(1) **PRELIMINARY INSTRUCTIONS.** Clean cover and oil pan with dry-cleaning solvent. Discard all gaskets.

(2) **INSTALL GASKETS AND SEALS.** Install new right (GM-6107364) and left (GM-6107365) side oil pan gaskets on block with gasket cement. Carefully position front and rear seals (GM-2071435) (gaskets) in grooves of main bearing caps.

(3) **INSTALL OIL PAN ASSEMBLY.** Carefully position oil pan, making certain that front and rear seals in bearing cap grooves are not tilted or pushed out of place. Secure oil pan in position with two screws and lock washers on each side of oil pan. Install balance of cross-recessed screws finger-tight, then install the four cap screws and lock washer, one at each side of front and rear bearing caps. Install oil cleaner outlet line connection to oil pump inlet and tighten securely. Tighten screws firmly.

(4) **INSTALL FLYWHEEL UNDERPAN AND EXTENSION.** Position and install extension on flywheel housing with two cross-recessed screws and lock washers. Tighten screws securely. Position and install flywheel underpan to flywheel housing, with four cross-recessed screws and lock washers, then tighten screws firmly.

TRUCK, 2½-TON, 6 x 6

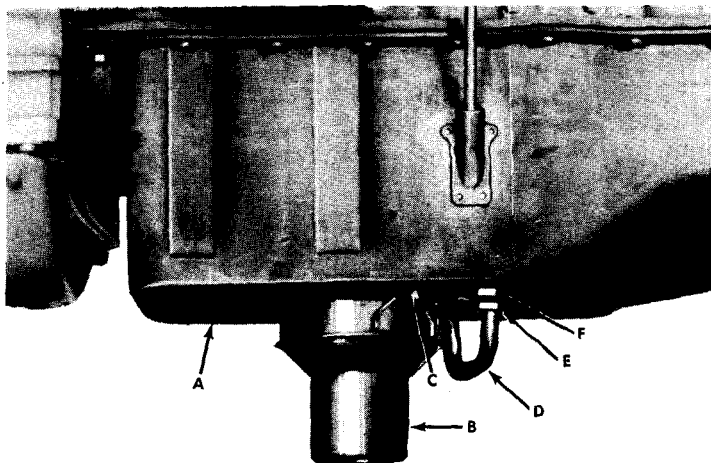

OIL PAN COVER REMOVED—SIDE VIEW

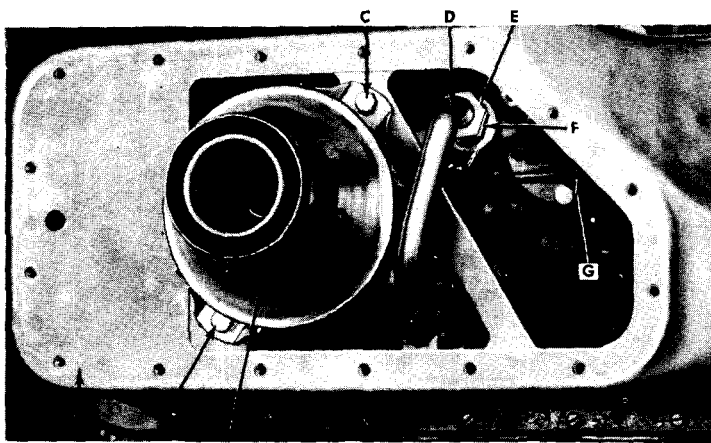

OIL PAN COVER REMOVED—BOTTOM VIEW

A OIL PAN
B OIL CLEANER ASSEMBLY
C CAP SCREW
D OIL CLEANER TO PUMP TUBE

E TUBING NUT
F TUBING NUT CONNECTOR
G OIL PUMP ASSEMBLY

RA PD 332902

Figure 66—Oil Pan Cover Removed

(5) **INSTALL OIL PAN COVER.** Install a new gasket (GM-2137800), using shellac, on under side of oil pan, then install oil pan cover less drain plug assembly.

(6) **INSTALL DRAIN PLUG ASSEMBLY.** Clean screen, deflector tube, plug. Use new gasket (GM-2137876). Make certain that screen is in good condition. Install drain plug assembly in oil pan cover and tighten securely. Install oil level indicator tube. Refill crankcase with proper lubricant.

**ENGINE DESCRIPTION, DATA, MAINTENANCE, AND
ADJUSTMENT ON VEHICLE**

81. OIL FILTER

a. **Description.** The replaceable element type oil filter is mounted on right-hand side of engine. A portion of the oil passing through the valve rocker arm oil line is directed through the oil filter where foreign elements are absorbed. Oil filtered in this manner is then returned directly to the engine oil pan through the fuel pump mounting.

b. **Oil Filter Element Replacement (fig. 67).**

(1) **REMOVE ELEMENT.** Remove attaching nut and lock washer and remove cover with gasket and spring. Remove drain plug and drain oil. Oil filter element may now be removed. Clean oil filter

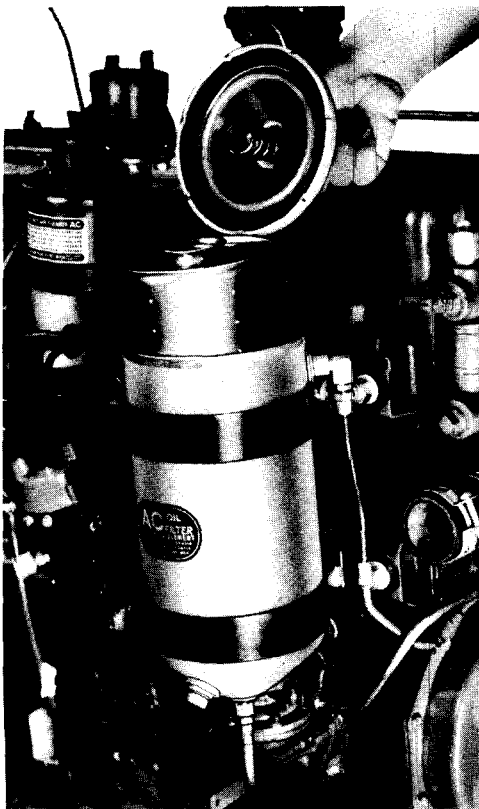

INSTALLED

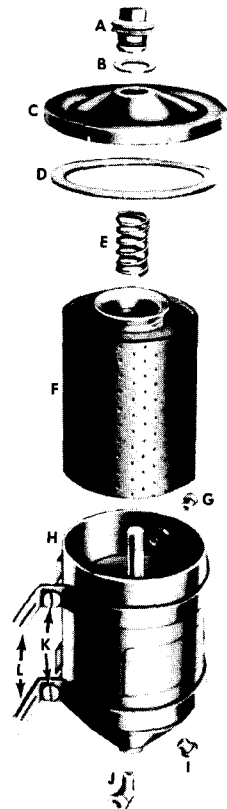

DISASSEMBLED

- A COVER STUD NUT
- B NUT GASKET
- C FILTER COVER
- D COVER GASKET
- E COVER SPRING
- F ELEMENT

- G INLET TUBE CONNECTOR
- H SHELL AND STUD
- I DRAIN PLUG
- J OUTLET TUBE CONNECTOR
- K CLAMP BOLT
- L FILTER CLAMP

Figure 67—Oil Filter Installed and Disassembled

RA PD 332931

TRUCK, 2½-TON, 6 x 6

body and cover with clean rag dipped in dry-cleaning solvent. Wipe all parts dry with a clean cloth.

(2) **INSTALL ELEMENT.** Install drain plug in bottom of oil filter. Install new filter element [(GM-1595502) G104-15-69149] in oil filter body (with a new cover gasket (GM-1504233) in place). Install spring and cover with gasket, using cover nut and gasket [(GM-853269) G150-01-94055].

c. **Filter Assembly Replacement** (fig. 67). Remove four filter clamp to bracket screws. Disconnect inlet (GM-2137793) and outlet [(GM-2136146) G501-04-07830] tubes at bottom of filter at filter. Withdraw filter and clamp as an assembly. Loosen upper and lower clamp screws to remove filter from clamp. Reinstall in reverse manner.

82. CRANKCASE VENTILATION SYSTEM.

a. **Description.** The ventilation of the crankcase, and the removal of fuel and water vapors within the crankcase are accomplished by the circulation of air actuated by manifold vacuum. Air is drawn into crankcase through breather filter (at oil filler tube) and after circulating through the engine, the air is drawn upward and out of the engine through the valve rocker arm cover, entering combustion

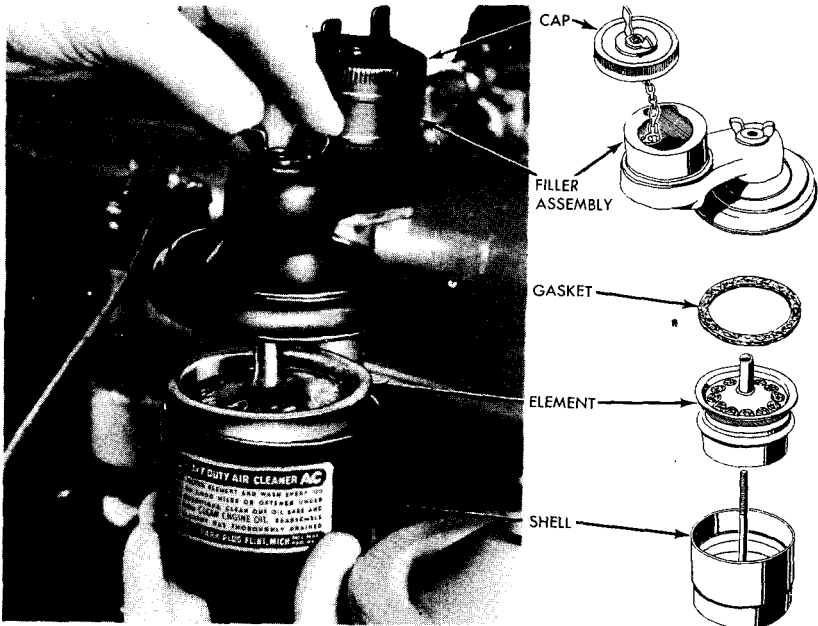

RA PD 332929

Figure 68—Crankcase Vent Cleaner

**ENGINE DESCRIPTION, DATA, MAINTENANCE, AND
ADJUSTMENT ON VEHICLE**

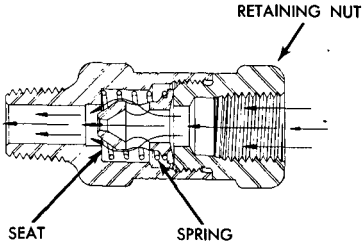

CROSS SECTION OF VALVE

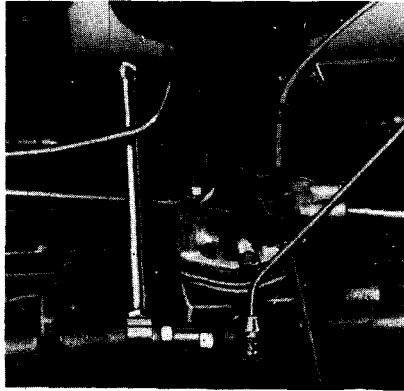

TUBE AND VALVE INSTALLED

RA PD 332927

Figure 69—Crankcase Vent Tube and Valve

chamber of engine through intake manifold. The manifold vacuum tube is connected to a fitting at the center of the valve rocker arm cover. The opposite end of the tube is connected to a fitting installed at the center of the intake manifold and contains a spring loaded plunger type valve which acts as restriction for vapor flow.

b. **Cleaning Ventilator Cleaner** (fig. 68). Loosen wing nut, then withdraw body and element. Clean filter element and reservoir in dry-cleaning solvent and permit element to drain. Fill reservoir with seasonal grade engine oil. Dip element in same oil and allow it to drain. Check condition of breather shell gasket [(GM-1543016) G501-01-94009]. Insert element in reservoir and reinstall to adapter. Tighten wing nut firmly. Check condition of oil filler cap gasket.

c. **Ventilator Tube and Valve Removal** (fig. 69). Disconnect tube at rocker arm cover fitting and at valve adapter elbow. Remove valve from intake manifold tee fitting. Remove nut from valve body which permits removal of restrictor valve and spring from body. Place all valve parts in dry-cleaning solvent to loosen accumulated foreign matter. Blow parts dry and clean, using compressed air. Install spring and restrictor valve inside valve body and thread nut into body. Tighten nut securely.

d. **Ventilator Tube and Valve Installation.** Apply anti-seize, mica-base compound to male threads of valve. Install valve on intake manifold tee. Install tube connection on valve elbow finger-tight. Install opposite end of tube on valve rocker arm fitting, making certain that tube is alined properly, then tighten connections firmly.

TRUCK, 2½-TON, 6 x 6

Section XV

ENGINE REMOVAL AND INSTALLATION**83. GENERAL.**

a. **Operation Sequence.** Removal and installation procedures outlined in this section are the result of actual try-out. Sequence of the operations are such as will permit the use of several mechanics if necessary, to accomplish the various disconnect operations without interference. One mechanic may perform disconnect operations; however, two men are required when the actual dismounting and mounting operations are accomplished.

b. **Facilities Required.** A chain hoist, suitable hoist support or A-frame, engine sling (41-S-3832-7), and a hydraulic jack are required, in addition to regular mechanic's tools.

84. REMOVAL.

a. **Preliminary** (Key letters in text refer to fig. 70). Raise hood and disconnect hood bracket (B) and bond straps (A) so that hood can be rested against windshield. Disconnect dash to hood side panel bond straps (C) and remove right and left side panels. Drain cooling system at radiator and cylinder block. Drain oil from crankcase and transmission. Disconnect cranking motor cable from battery.

b. Front of Engine.

(1) **DISCONNECT RADIATOR HOSES.** Disconnect radiator upper and lower hoses. Open clips which attach front wiring harness to upper portion of radiator.

(2) **DISCONNECT BRUSH GUARD.** Remove six bolts, nuts, and internal-external toothed lock washers which attach brush guard to right- and left-hand fenders, three at each fender. Remove eight bolts, nuts, and internal-external toothed lock washers which attach brush guard to front right- and left-hand side panels, four at each side. Remove two nuts, bolts, and internal-external toothed lock washers (Z) which attach two radiator support braces to radiator support, one at each side of radiator.

(3) **DISCONNECT RADIATOR AND FRONT ENGINE SUPPORT BOLTS.** Remove two nuts and internal-external toothed lock washers which attach bond straps to front of radiator bottom tank. After straps are removed, reinstall nuts and washers on studs finger-tight. Remove two nuts, a washer, and spring from each radiator support bolt. Remove cotter pins, castellated nuts, and lock washers from front engine support bolts (fig. 72). Disconnect two frame to engine oil pan bond straps (V) from engine.

(4) **REMOVE RADIATOR TIE ROD.** Remove two nuts and internal-external toothed lock washers from tie rod at rear side of dash. Remove two screws and internal-external toothed lock washers attaching tie rod to radiator support. Lift tie rod up, pull forward, and remove from vehicle.

ENGINE REMOVAL AND INSTALLATION

(5) **REMOVE BRUSH GUARD AND RADIATOR ASSEMBLY.** Remove brush guard and radiator as an assembly by pulling assembly away from front of engine and upward away from front crossmember.

c. Right-hand Side of Engine.

(1) **DISCONNECT FUEL LINES.** Disconnect flexible tube at fuel pump. Disconnect metal line at rear of fuel filter (H), then spring

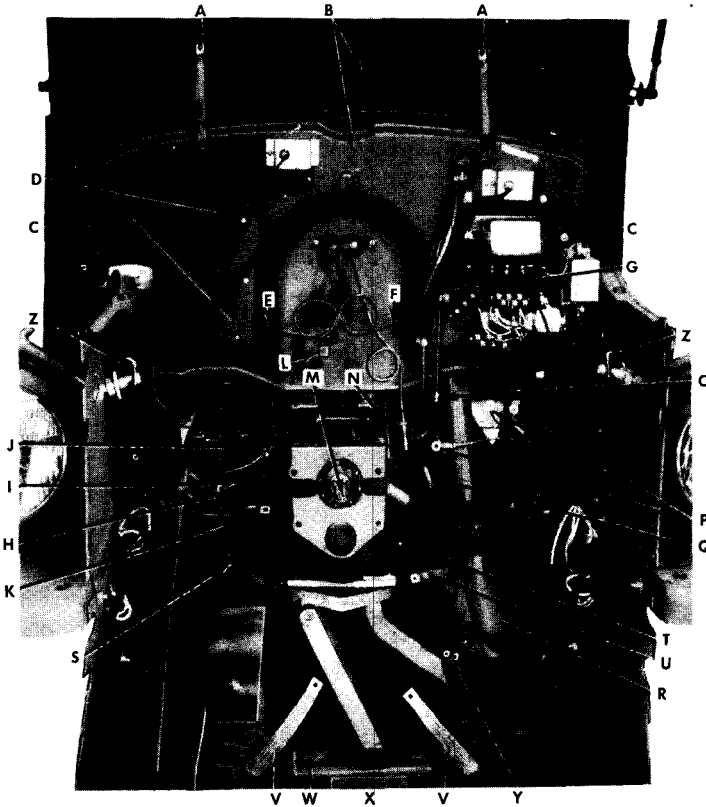

- | | |
|---|---|
| A DASH TO HOOD BOND STRAPS | N HEAT INDICATOR THERMAL UNIT |
| B HOOD BRACKET | O ENGINE TO OIL PRESSURE GAGE TUBE |
| C DASH TO HOOD SIDE PANEL BOND STRAPS | P GENERATOR TERMINAL WIRES |
| D IGNITION COIL FILTER WIRE | Q BRAKE PEDAL ROD |
| E HAND THROTTLE CONTROL | R EXHAUST PIPE |
| F CHOKE CONTROL | S RIGHT-HAND REAR ENGINE SUPPORT INSULATOR ASSEMBLY |
| G WINDSHIELD WIPER TUBE | T LEFT-HAND REAR ENGINE SUPPORT INSULATOR ASSEMBLY |
| H TANK TO FUEL FILTER LINE | U FRAME TO FLYWHEEL HOUSING BOND STRAP |
| I HYDROVAC VACUUM LINE | V FRAME TO ENGINE OIL PAN BOND STRAPS |
| J CRANKING MOTOR TO AMMETER CABLE | W ENGINE FRONT SUPPORT ASSEMBLY |
| K BATTERY TO CRANKING MOTOR CABLE | X RADIATOR CUSHION |
| L DASH TO VALVE ROCKER ARM COVER BOND STRAP | Y HORN TERMINAL WIRES |
| M TRANSMISSION MAIN DRIVE GEAR SHAFT | Z RADIATOR SUPPORT BRACES |

RA PD 332958

Figure 70—Items Which Must Be Disconnected to Remove Engine

TRUCK, 2½-TON, 6 x 6

line toward frame side rail to prevent damage to line during engine removal.

(2) **REMOVE FUEL FILTER.** Remove two bolts, nuts, and lock washers which attach fuel filter to bracket and remove filter.

(3) **DISCONNECT CRANKING MOTOR TERMINAL WIRES.** Remove wires and cable from cranking motor (J and K). Reinstall washer and nut on terminal finger-tight.

(4) **DISCONNECT HYDROVAC VACUUM LINE.** Loosen clamp bolt and disconnect flexible vacuum line (I) at rear of cranking motor, just above flywheel housing.

(5) **DISCONNECT IGNITION COIL WIRE.** Remove nut which secures wire (D) to ignition coil positive (+) terminal and remove wire. Reinstall nut on coil terminal finger-tight, and loop wire around hood hinge on cowl. Disconnect radio suppression bond strap (L) from valve rocker arm cover.

d. Left-hand Side of Engine.

(1) **REMOVE AIR CLEANER.**

(a) *Clamp-on Type.* Loosen clamp bolt at throat of air cleaner, loosen nut at top of air cleaner brace, then lift air cleaner assembly from carbureter.

(b) *Flange Type.* Unscrew wing nut at center of cover, then lift cleaner off center tube.

(2) **DISCONNECT CARBURETER LINKAGE AND WINDSHIELD WIPER TUBE.** Disconnect choke control (F), and hand throttle control (E) from carbureter. Disconnect flexible windshield wiper tube (G) from metal tube which is attached to intake manifold.

(3) **DISCONNECT WIRES FROM HORN AND GENERATOR.** Disconnect wires (Y) from horn, then reinstall screws and washers finger-tight. Disconnect wires (P) from generator, then reinstall nuts and washers on respective terminals.

(4) **DISCONNECT EXHAUST PIPE AND ACCELERATOR ROD.** Remove bolts and nuts which attach exhaust pipe (R) to manifold, then separate pipe and flange from manifold. Remove cotter pin which secures accelerator rod in carbureter control lever and remove rod from lever.

(5) **REMOVE THERMAL UNIT.** Unscrew heat indicator thermal unit (N) from cylinder head. Care must be used that unit and line are not damaged.

(6) **DISCONNECT OIL GAGE TUBE.** Disconnect flexible oil gage tube (O), using two wrenches to prevent twisting flexible tube.

e. Inside of Cab.

(1) **DISCONNECT ACCELERATOR PEDAL AND CRANKING MOTOR BUTTON.** Remove cotter pin and clevis pin from accelerator pedal, then free rod from pedal. Reinsert pin in pedal and install cotter pin temporarily. Unscrew button from cranking motor cross shaft lever.

(2) **REMOVE TOE BOARD PLATE.** Remove screws and washers which attach toe board plate around steering column and clutch and brake pedals and remove plate and seal assembly.

(3) **REMOVE FLOOR AND TOE BOARDS.** Remove 12 floor board cap screws and external toothed lock washers. Remove five toe board cap screws and external toothed washers. Place transfer case shift

ENGINE REMOVAL AND INSTALLATION

levers in neutral and pull hand brake lever back; then lift seal off over levers. Move shift levers as necessary and lift out floor board. Lift toe board from cab.

(4) **REMOVE CRANKING MOTOR CROSS SHAFT ASSEMBLY.** Remove cotter pin and washer from cross shaft lever to cranking motor lever rod. Disconnect cranking motor lever pull back spring. Remove four cap screws and lock washers which attach cranking motor cross shaft assembly on clutch housing. Lift cross shaft and two spacer blocks away from housing. Remove cotter pin and clevis pin attaching brake pedal pull rod to brake pedal to disconnect rod from brake pedal.

f. Under Vehicle.

(1) **REMOVE CLUTCH AND BRAKE PEDAL AND BRACKET ASSEMBLY.** Disconnect clutch pedal pull back spring from adjusting link and unhook pedal from link. Remove two cap screws and lock washers which attach spring clip to clutch housing. Remove three cap screws and lock washers which attach pedal and bracket assembly to clutch housing and transmission and lift out pedal and bracket assembly.

(2) **REMOVE FLYWHEEL UNDERPAN.** Remove four screws and lock washers which attach flywheel underpan to clutch housing, then disconnect radio suppression bond strap (U).

(3) **REMOVE REAR MOTOR SUPPORT BOLTS.** Remove bolts on right- and left-hand sides of engine at rear motor support brackets (fig. 72).

(4) **POSITION JACK UNDER TRANSMISSION.** Place jack under transmission. Position jack so that it will not interfere with engine removal.

(5) **DISCONNECT TRANSMISSION.** Remove lock wire from heads of two clutch housing to transmission lower cap screws, accessible from inner side of housing. Remove both cap screws, then remove two clutch housing to transmission upper cap screws.

g. Withdraw Engine.

(1) Install engine sling (41-S-3832-7) on engine. Take up tension on hoist, and raise transmission jack slightly to take load.

(2) Hoist engine in short stages and at same time raise transmission slightly to prevent weight of transmission resting on transmission main drive gear shaft (M).

(3) Continue to raise engine slowly and at same time pull engine toward front to clear transmission main drive gear shaft and cowl. **CAUTION: Do not permit clutch release bearing and support assembly to drop from release fork.** When engine is raised enough to clear side support brackets, continue to hoist until oil pan will clear front crossmember. Spring front side panels apart slightly to clear engine and pull engine out from front of chassis (fig. 71).

85. INSTALLATION.

a. **Preliminary Instructions** (Key letters in text refer to fig. 70). Before installing engine in chassis, the engine front support assembly (W) must be removed and inspected for fit in lower retainer and upper plate.

(1) **REMOVE ENGINE FRONT SUPPORT ASSEMBLY.** Remove cotter pin and nut from two bolts attaching engine front support assembly

TRUCK, 2½-TON, 6 x 6

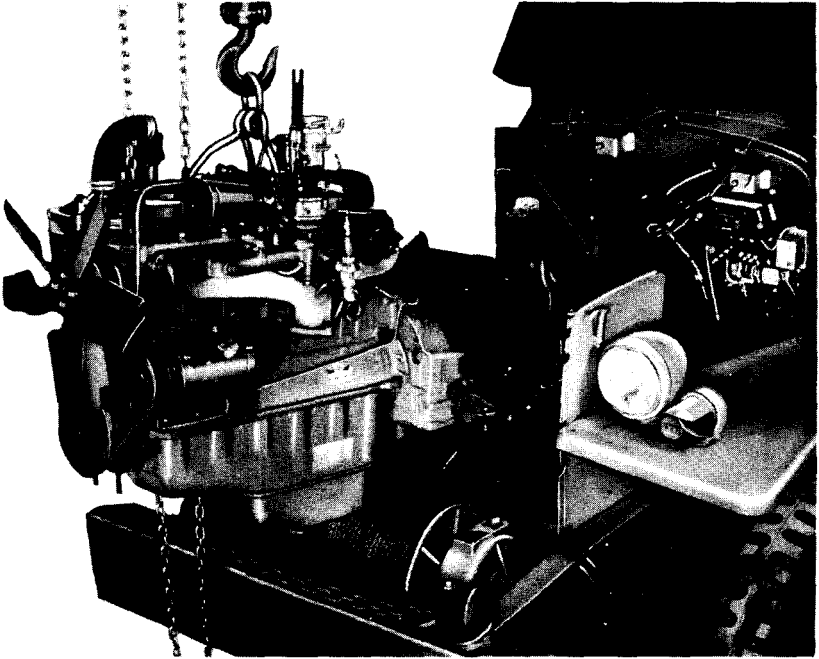

RA PD 332967

Figure 71—Engine Removal or Installation

to front crossmember. Drive bolts up out of crossmember and support assembly and lift assembly off crossmember.

(2) **CHECK CLEARANCE** (fig. 72). Fit front support assembly into lower retainer and position upper plate on top. With parts held together firmly, determine if rubber support assembly fits tight between upper plate and lower retainer. Also check engine mounting bushings to be sure they project above upper plate. If rubber support is loose between upper plate and lower retainer, or if bushings do not project above upper plate, install a new support assembly. Check clearance between upper plate and lower retainer at point indicated in figure 72. If clearance is more than $\frac{5}{64}$ inch, a new lower retainer must be installed.

(3) **INSTALL ENGINE FRONT SUPPORT ASSEMBLY**. Place front support assembly in lower retainer and position upper plate on top. Position the assembly on front crossmember with curved edge of upper plate toward front. Insert two bolts down through upper plate, support assembly, lower retainer, and crossmember. If used support assembly is being reinstalled, install nuts on bolts, tighten firmly, and install cotter pins. If new support assembly is being installed, clearance between upper plate and lower retainer must be checked before bolts are tightened (fig. 72). If clearance is less than $\frac{3}{64}$ inch, file or grind top of lower retainer until proper clearance is obtained. Do not use shims. If clearance is more than $\frac{5}{64}$ inch, install

ENGINE REMOVAL AND INSTALLATION

new lower retainer. Tighten nuts and install cotter pins. Position oil shield over front support assembly.

b. Mount Engine in Chassis. Make certain that insulators (S and T) on rear engine supports are in good condition before installing engine. Position and secure lifting hooks on engine assembly so as to properly balance engine, then lift and position engine over chassis. Carefully lower engine assembly until clutch housing recess is properly aligned with transmission main drive gear shaft. Make sure clutch release bearing and support assembly is in place in clutch release fork. Push engine assembly carefully and firmly toward rear of vehicle; at the same time guide transmission shaft into clutch release bearing. While rocking engine slowly from side to side, push engine toward transmission until shaft splines engage hub of clutch disc. Lift or lower engine as necessary to seat shaft in clutch disc hub properly. Push engine assembly toward transmission until clutch housing face seats solidly against transmission case. Lower jack located under transmission, while lowering engine assembly in place.

(1) **ATTACH TRANSMISSION TO CLUTCH HOUSING.** Install and tighten two clutch housing to transmission lower cap screws, then two upper cap screws and lock washers. Insert lock wire through heads of lower cap screws, draw wire taut, and twist ends securely.

(2) **INSTALL REAR MOTOR SUPPORT BOLTS.** Aline rear motor support insulators (S and T) with brackets. With a lock washer installed over end of bolt, carefully screw each bolt into place (fig. 72). Make

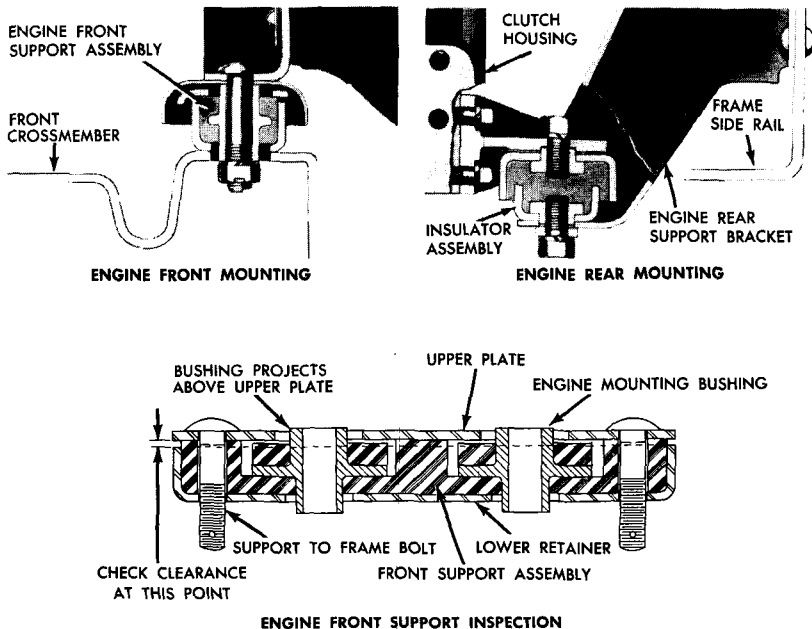

Figure 72—Engine Front and Rear Mounting

RA PD 332970

TRUCK, 2 1/2-TON, 6 x 6

certain that bolt threads are not crossed during this operation. Tighten bolts firmly.

(3) **INSTALL FLYWHEEL UNDERPAN.** Position and align flywheel underpan on clutch housing. Attach pan in place with four screws and lock washers. Attach radio suppression bond strap (U) and tighten screws firmly.

(4) **INSTALL CLUTCH AND BRAKE PEDAL AND BRACKET ASSEMBLY.** Position pedal and bracket assembly against clutch housing and transmission, then install three cap screws and lock washers which attach bracket. Tighten cap screws firmly. Hook adjusting link onto clutch pedal and hook clutch pedal pull back spring onto adjusting link.

d. Left-hand Side of Engine.

(1) **INSTALL THERMAL UNIT.** Screw thermal unit (N) into cylinder head. Make certain that line attached to unit is not twisted during installation.

(2) **CONNECT OIL GAGE TUBE.** Connect flexible oil line to oil pressure gage tube (O). Use two wrenches while tightening connection to prevent twisting. Insert accelerator rod end in carburetor control lever, which is attached to cylinder block, then insert cotter pin in rod.

(3) **CONNECT EXHAUST PIPE.** Place flange seal and new gasket on top of exhaust pipe flange (R) and raise exhaust pipe flange up against exhaust manifold. Insert three bolts up through exhaust pipe flange and manifold and install nuts on bolts. Tighten nuts alternately and evenly, then install Palnuts on bolts.

(4) **INSTALL WIRES ON HORN AND GENERATOR.** Remove screws and lock washers from horn terminals, then position wires (Y) and reinstall screws and lock washers. Tighten screws firmly. Remove nuts and internal-external toothed lock washers from generator wire terminals and install wires (P) on respective terminals. Attach wires with washers and nuts.

(5) **CONNECT CARBURETOR LINKAGE AND WINDSHIELD WIPER TUBE.** Install choke control housing (F) in clamp and insert wire through swivel block on choke control lever. Hook carburetor control rod through throttle lever. Install hand throttle control housing (E) in clamp and insert wire through hole in carburetor control rod. Install stop collar on end of wire and tighten screw in a collar. Install windshield wiper tube (G) on vacuum line from intake manifold.

(6) **INSTALL AIR CLEANER.**

(a) *Flange Type.* Position cleaner assembly over center tube attached to carburetor. Thread wing nut onto stud and tighten snugly.

(b) *Clamp-on Type.* Place air cleaner on top of carburetor and at the same time align bolt at side of air cleaner in slot of air cleaner brace. Press assembly in place and tighten clamp bolt and brace nut.

e. Right-hand Side of Engine.

(1) **INSTALL COIL WIRE AND VALVE COVER BOND STRAP.** Attach radio suppression bond strap (L) on valve rocker arm cover rear stud with internal-external toothed lock washer and nut. Tighten nut firmly. Install wire (D) on ignition coil positive (+) terminal.

ENGINE REMOVAL AND INSTALLATION

(2) **CONNECT CRANKING MOTOR TERMINAL WIRES.** Remove nut and washer from cranking motor terminal, and install cable and wires (J and K) on terminal. Attach wires on terminal with nut and washer. Tighten nut firmly.

(3) **INSTALL FUEL FILTER.** Position fuel filter on bracket, and attach with two bolts, nuts, and lock washers.

(4) **CONNECT FUEL LINES.** Connect flexible tube at fuel pump. Position and connect metal line (H) at rear of filter.

(5) **CONNECT HYDROVAC VACUUM LINE.** Insert metal tube in flexible hose (I), position hose clamp, then tighten clamp bolt firmly.

f. Front of Vehicle.

(1) **INSTALL BRUSH GUARD AND RADIATOR ASSEMBLY.** Align shims and radiator cushion with holes in frame front crossmember; then apply one or two short pieces of tape to hold cushion and shims in alignment when radiator assembly is installed. Carefully place brush guard and radiator assembly in position on front crossmember between the two side panels.

(2) **ATTACH BRUSH GUARD.** Install bolts which attach radiator support braces (Z) to radiator support; then install internal-external toothed lock washers and nuts. Install six bolts, nuts, and internal-external toothed lock washers (one under head of each bolt and nut) attaching brush guard to fenders (three on each side). Install eight bolts, nuts, and internal-external toothed lock washers (four at each side) which attach brush guard to right- and left-hand side panels in the same manner. Tighten all nuts firmly.

(3) **CONNECT RADIATOR HOSES AND INSTALL TIE ROD.** Install upper and lower radiator hoses, position hose clamps, and tighten clamp bolts firmly. Screw inner (forward) nuts well up on ends of tie rod. Place new internal-external toothed lock washers over ends of tie rod and insert ends of tie rod through holes in dash. Attach front end of tie rod to radiator support with two screws and new internal-external toothed lock washers. Tighten screws firmly.

(4) **ATTACH RADIATOR AND FRONT ENGINE SUPPORT BOLTS.** Install in following order a spring, washer, and two nuts on each radiator support bolt. Tighten nuts until springs are compressed, then back off nuts three full turns to provide proper tension on springs. Tighten lock nuts securely. Install lock washers and castellated nuts on front motor support bolts. Tighten nuts and install cotter pins. Attach radiator bond straps to bottom of radiator. Attach bond straps (V) to front of engine oil pan.

(5) **INSTALL SIDE PANELS AND CONNECT HOOD.** Attach left- and right-hand rear side panels with bolts, nuts, and internal-external toothed lock washers. Attach radio suppression bond straps (C). Position and install hood bracket (B) on cab cowl. Attach two radio suppression bond straps (A) with screws and internal-external toothed lock washers.

g. Inside Cab.

(1) **INSTALL NUTS ON RADIATOR TIE ROD.** Install nuts and new internal-external toothed lock washers on ends of tie rod. Adjust nuts on each side of dash to obtain a $\frac{3}{4}$ -inch clearance between fan blades

TRUCK, 2 1/2-TON, 6 x 6

and bottom of radiator. After correct adjustment is obtained, tighten nuts firmly.

(2) **INSTALL CRANKING MOTOR CROSS SHAFT ASSEMBLY.** Position spacer blocks and cross shaft assembly on top of clutch housing. Insert cap screw, with lock washer installed, through oil pressure line clip, then through cross shaft bracket and screw into clutch housing. Install other three cap screws and lock washers which attach cross shaft assembly to clutch housing and tighten firmly. Attach brake pedal pull rod to brake pedal with clevis pin and cotter pin.

(3) **INSTALL TOE BOARD AND FLOOR BOARD.** A visual check must be made before toe board and floor board are installed to ascertain that all connections have been made and that all bolts, etc., are in place and tightened securely. Position toe board in cab and attach with five cap screws and external toothed lock washers. Tighten cap screws firmly. Aline levers in cab as necessary and install floor board. Attach floor board with 12 cap screws and external toothed lock washers. Install floor seal over ends of hand brake and transfer case levers.

(4) **INSTALL TOE PLATE.** Carefully place toe plate and seal in position around pedals and steering column, aline screw holes, and attach with screws and lock washers.

(5) **INSTALL ACCELERATOR PEDAL.** Remove cotter pin and clevis pin from pedal, position accelerator rod under pedal, insert clevis pin through pedal and rod and install cotter pin.

h. Final Operations. Fill cooling system, crankcase, and transmission. Connect cranking motor cable to battery.

- (1) Make following adjustments.
 - (a) Clutch pedal free-travel (par. 150).
 - (b) Brake master cylinder linkage (par. 187).
 - (c) Brake pedal to toe board clearance (par. 186).
 - (d) Transmission strut rod adjustment (par. 155).
 - (e) Transfer case control rod adjustment (par. 160).
 - (f) Choke control (par. 95).
 - (g) Throttle control (par. 95).
 - (h) Adjust fan belt tension (par. 108).
 - (i) Polarize generator (par. 117).
 - (j) Tune-up engine (par. 76).

Section XVI

IGNITION SYSTEM

86. DESCRIPTION AND DATA.

a. Description (fig. 73). The ignition system consists of the source of power (battery or generator), ignition switch, ignition coil, distributor, condenser, spark plugs, and high and low tension wiring. The ignition system functions to produce and deliver high voltage surges to the correct spark plug at the correct intervals and with

IGNITION SYSTEM

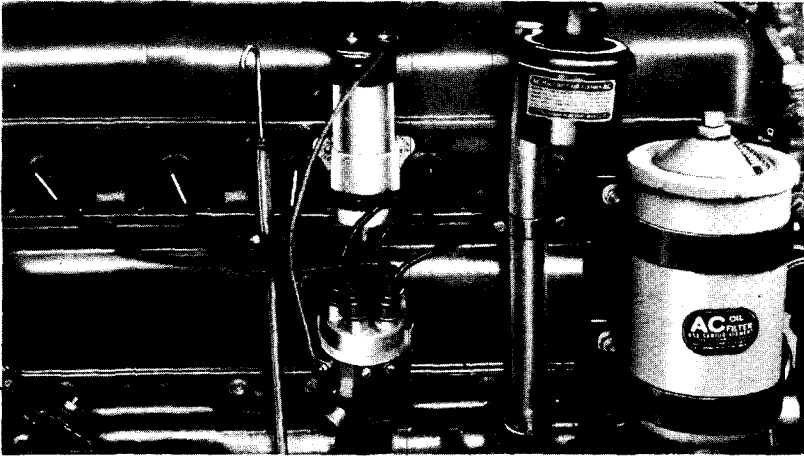

Figure 73—Ignition System Units Installed

RA PD 332912

correct timing to the engine. Each high voltage surge produces a spark at the spark plug gap to which it is delivered, so that the mixture of air and fuel in the cylinder is ignited.

b. **Circuit Description** (fig 74). There are two distinct electrical circuits in the ignition system, the *primary* and the *secondary*. When these electrical circuits are kept in mind, as well as the functions of the various units in the system to accomplish these circuits, a better understanding may be had of the operation of the entire system.

(1) **PRIMARY CIRCUIT.** The primary, or low tension circuit, includes the source of electrical energy (battery or generator), distributor contact points and circuit breaker mechanism, primary circuit of the ignition coil, and condenser.

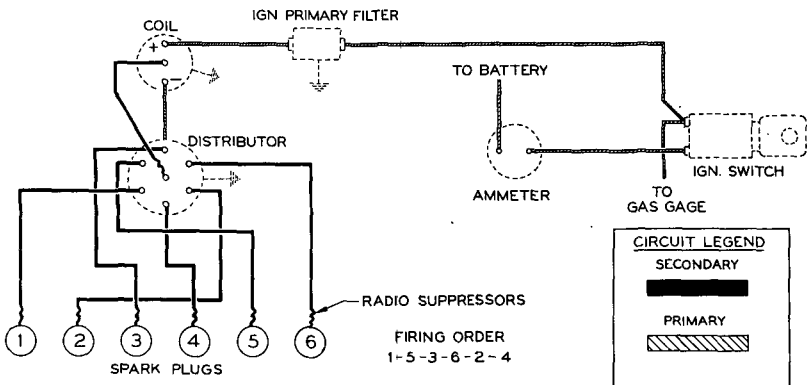

Figure 74—Ignition System Circuits

RA PD 332966

TRUCK, 2 1/2-TON, 6 x 6

(2) **SECONDARY CIRCUIT.** The secondary, or high tension circuit, includes the secondary circuit of the coil, distributor rotor and cap, high tension wiring, and spark plugs.

c. **Data.**

(1) **DISTRIBUTOR.**

MakeDelco Remy
 Model1110135
 Breaker point gap.....0.018-0.024 in.
 Breaker arm tension.....17 to 21 oz
 Firing order1-5-3-6-2-4
 Initial ignition timing.....5 deg before upper dead center

(2) **SPARK PLUGS.**

MakeAC
 Type44
 Size14MM
 Point gap.....0.025 in.

(3) **IGNITION COIL.**

MakeDelco Remy
 Model1115149

87. **IGNITION TIMING.**

a. Timing the ignition system comprises (1), initial timing—setting of the distributor mechanism to permit opening of the points at correct firing intervals and (2), manual advance—retarding or advancing the point opening to compensate for the various grades of fuel which may be used. These timing factors require checking and adjustment at regular intervals or when performance of engine necessitates such action.

b. **Initial Timing.**

(1) **LOCATE NO. 1 CYLINDER FIRING POSITION.** Locate No. 1 cylinder spark plug wire on distributor cap, then place a mark on distributor body opposite No. 1 wire in cap. Remove distributor cap. Clean and adjust point opening if necessary (par. 88).

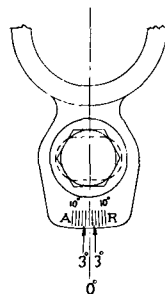
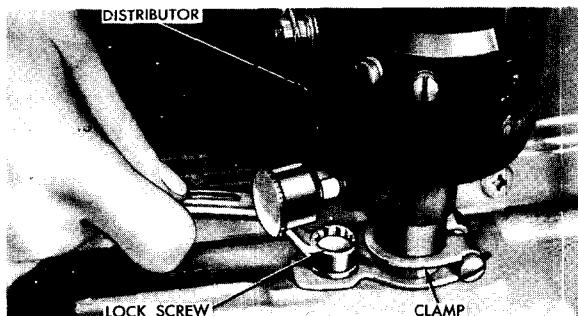

Figure 75—Manual Advance Adjustment

RA PD 332866

IGNITION SYSTEM

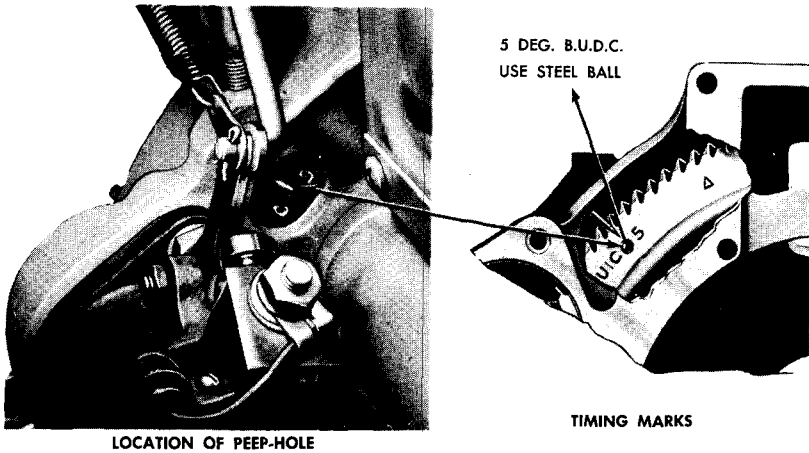

Figure 76—Flywheel Timing Marks

RA PD 332900

(2) **SET MANUAL ADVANCE.** Set manual advance at zero—halfway between “R” and “A” (fig. 75).

(3) **CHECK TIMING.** Do not turn ignition switch on. Have someone slowly crank engine and watch timing mark on flywheel (fig. 76). Crank engine slowly until flywheel mark is exactly in line with pointer on flywheel housing. With pointer and flywheel mark lined up, rotor should point toward mark placed on distributor body. Timing should be checked and adjusted by method described in steps (a) and (b) below.

(a) *With Engine Not Running.* With flywheel mark exactly in line with pointer and distributor rotor pointing to No. 1 spark plug position, points should just begin to open. Loosen clamp screw (fig. 77) and turn distributor housing in clockwise direction until points close. Disconnect the high tension wire from the coil to the distributor at the distributor cap. Turn on ignition switch and hold the end of the high tension wire $\frac{1}{4}$ inch from a ground, then turn distributor housing in a counterclockwise direction until a spark jumps the gap between the high tension wire and the ground. When the spark occurs, the points are open; holding the distributor in this position, tighten clamp screw securely. Turn ignition switch off.

(b) *With Engine Running.* Replace distributor cap. Attach one lead of timing light (41-L-1440) to No. 1 spark plug terminal and other lead to a convenient ground. Start engine and run at idling speed. Direct beam of timing light toward flywheel housing peephole. Timing light flashes make timing mark on flywheel appear stationary. Loosen clamp screw (fig. 77) and move distributor body clockwise or counterclockwise as necessary to synchronize flashes with flywheel mark when it is aligned with pointer on flywheel housing. Tighten clamp screw.

TRUCK, 2½-TON, 6 x 6

c. Manual Advance Adjustment (fig. 75).

(1) DRIVE VEHICLE. After engine has been thoroughly warmed up, drive vehicle, using grade of fuel expected to be used in service. Engine should not "ping" or "clatter" excessively under load and full throttle.

(2) ADJUST MANUAL ADVANCE. A slight amount of "ping" is not objectionable. If excessive amount of knock exists, loosen cap screw (fig. 75) and turn distributor body toward "R" on distributor clamp until knock is minimized. Tighten cap screw when adjustment is made. With manual advance set at "zero," engine should perform satisfactorily when 75 octane fuel is used. It will be necessary to retard manual advance approximately three degrees when using 70-72 octane fuel and advance three degrees with 80 octane fuel. Several trials and adjustments may be necessary, as a general rule, to obtain good performance with grade of gasoline used.

88. DISTRIBUTOR, POINTS, AND CONDENSER.

a. Distributor assembly is mounted on the right-hand side of the engine and is driven from the camshaft by spiral gears. The lower end of the distributor drive shaft is tongued and engages a slot on the upper end of the oil pump drive shaft. NOTE: *Some early vehicles were equipped with a radio interference suppressor filter on the distributor. This filter may strike and break the fuel line. If a filter is found, remove and discard it.*

b. Point Adjustment.

(1) CLEAN POINTS. Remove distributor cap [(GM-1867722)

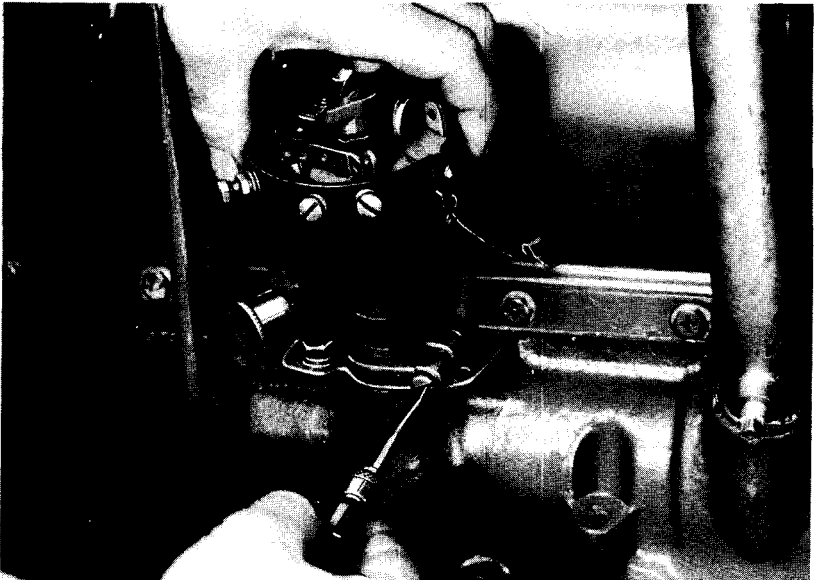
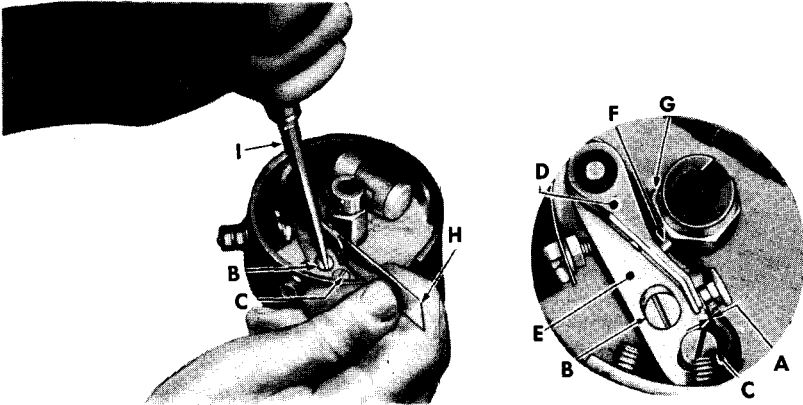

Figure 77—Initial Timing Adjustment

RA PD 332858

IGNITION SYSTEM



- | | |
|-------------------------|-----------------------|
| A POINT OPENING | F FIBRE RUBBING BLOCK |
| B ECCENTRIC SCREW | G CAM |
| C CLAMP SCREW | H FEELER GAGE |
| D BREAKER LEVER | I SCREW DRIVER |
| E CONTACT POINT SUPPORT | |

RA PD 64554

Figure 78—Distributor Points Installed

G102-04-00420] and rotor [(GM-1883500) G102-01-03121]. Clean points thoroughly, using a fine magneto type file.

(2) **SET BREAKER LEVER.** Hand crank engine slowly until breaker lever pad rests on a high point of distributor cam.

(a) **Check Breaker Arm Spring Tension.** With contact spring scale, check tension of arm spring in manner illustrated in figure

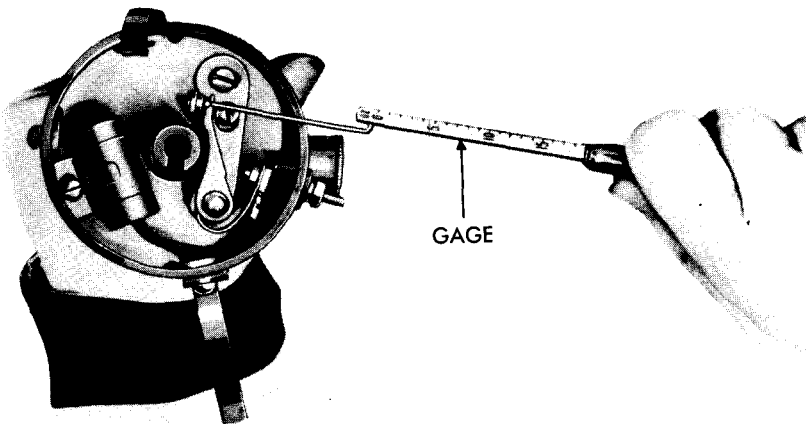

RA PD 332844

Figure 79—Testing Breaker Lever Spring Tension

TRUCK, 2½-TON, 6 x 6

79. If tension falls below 17 ounces, replace points as described in subparagraphs c and d below.

(b) *Gage and Adjust Points* (fig. 78). With a feeler gage, measure point opening. If not within 0.018 to 0.024 inch, loosen clamp screw and turn eccentric screw until gap is correct. Tighten clamp screw after adjustment is made. Reinstall rotor and cap.

c. **Point Removal** (fig. 78).

(1) **REMOVE BREAKER LEVER.** Remove cap and rotor. Loosen primary terminal nut, then remove condenser pigtail connection from terminal. Pull up on breaker lever and remove from pivot, at the same time removing end of lever spring from primary terminal.

(2) **REMOVE CONTACT POINT AND SUPPORT.** Remove clamp screw, then lift off contact point and support [(GM-1855720) G85-33-02520] over eccentric screw.

d. **Point Installation.**

(1) **INSTALL CONTACT POINT AND SUPPORT.** Place contact point and support assembly in position in distributor over eccentric screw. Install clamp screw and tighten securely.

(2) **INSTALL BREAKER LEVER.** Place breaker lever over pivot and at the same time, install end of lever spring over terminal. Install condenser pigtail connection over terminal. Tighten terminal nut securely.

(3) **CHECK BREAKER LEVER SPRING TENSION.** New breaker lever springs are generally stronger than required in operation. Check the tension (17-21 oz) in manner illustrated in figure 79. If neces-

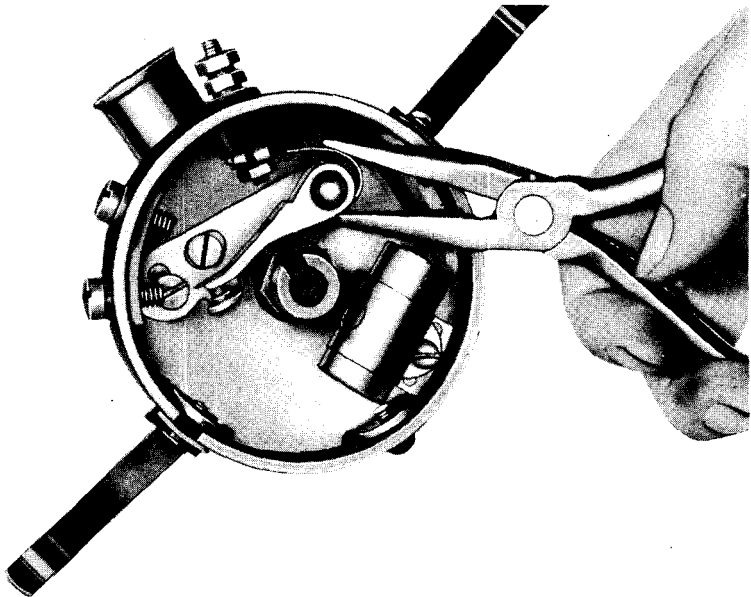

Figure 80—Bending Spring to Decrease Tension

RA PD 332857

IGNITION SYSTEM

sary to decrease pressure, *slightly* bend spring in manner shown in figure 80. To increase point pressure, lever arm must be removed and spring bent away from lever. Avoid excessive distortion of the spring, as only a small change in spring tension is normally required.

(4) **ADJUST POINT OPENING.** Adjust opening as described in subparagraph **b** above. Check timing.

e. Condenser Replacement.

(1) **REMOVE CONDENSER.** Remove distributor cap and rotor. Remove screw and lock washer attaching condenser to breaker plate. Remove nut and washer from primary terminal and remove condenser lead from terminal. Lift condenser [(GM-1869704) G102-15-39899] out of distributor.

(2) **INSTALL CONDENSER.** Position condenser on breaker plate and attach with screw and lock washer. Place condenser lead on primary terminal and attach with nut and washer. Install rotor and distributor cap.

f. Distributor Assembly Removal.

(1) **CRANK ENGINE TO NO. 1 FIRING POSITION** (fig. 81). Remove cap and wires. Crank engine until No. 1 piston is ready to fire, i.e., with rotor pointing to No. 1 spark plug wire and flywheel timing mark on position shown in figure 76. Distributor can be removed and new assembly installed readily *while engine remains in this position*. If same distributor is to be reinstalled, mark relative position of No. 1 spark plug wire on body of distributor directly opposite rotor.

(2) **LOOSEN HOLD DOWN CLAMP SCREW.** Loosen clamp bracket bolt (fig. 77). Lift distributor [(GM-1110135) G501-01-52015] straight up until it disengages from spiral gear. The rotor will turn a few degrees *clockwise* as gear disengages. Mark body opposite *this* rotor position. Lift distributor straight up from engine.

g. Distributor Assembly Installation.

(1) **IF ENGINE HAS NOT BEEN CRANKED** since removal of distributor (subpar. **f** (1) above), locate rotor in No. 1 firing position. If assembly is new, the No. 1 position can be determined by mark on the old distributor (subpar. **f** (1) above), or place the rotor in approximately the position shown in figure 81, then turn rotor slightly *clockwise*. As distributor is inserted into place, the spiral gear will cause rotor to turn back (*counterclockwise*). It may be necessary to insert the assembly several times to finally bring rotor to No. 1 firing position.

(2) If engine has been cranked since the removal of distributor, it will be necessary to again place engine with No. 1 piston in firing position. This can be accomplished as follows:

(a) Remove valve rocker arm cover. Hand crank engine and observe movement of No. 1 intake valve (second valve from the front). When it is noticed that intake valve is closing (raising up), continue to crank slowly and at same time watch flywheel timing mark peep-hole. Crank slowly until flywheel timing pointer is on the steel ball

TRUCK, 2½-TON, 6 x 6

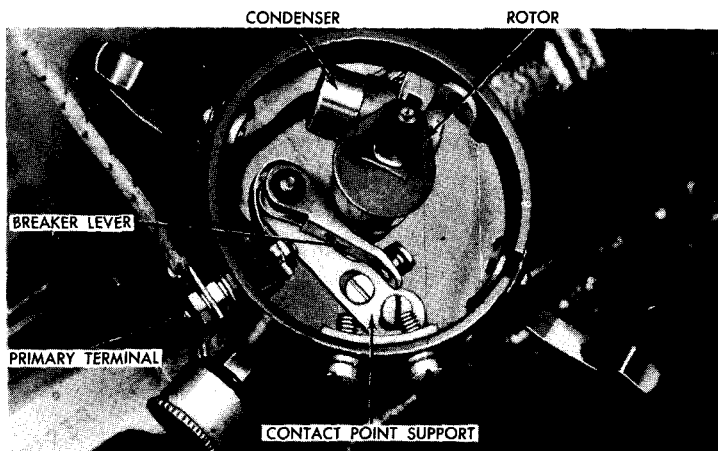

POSITION OF ROTOR AT NO. 1 FIRING POSITION

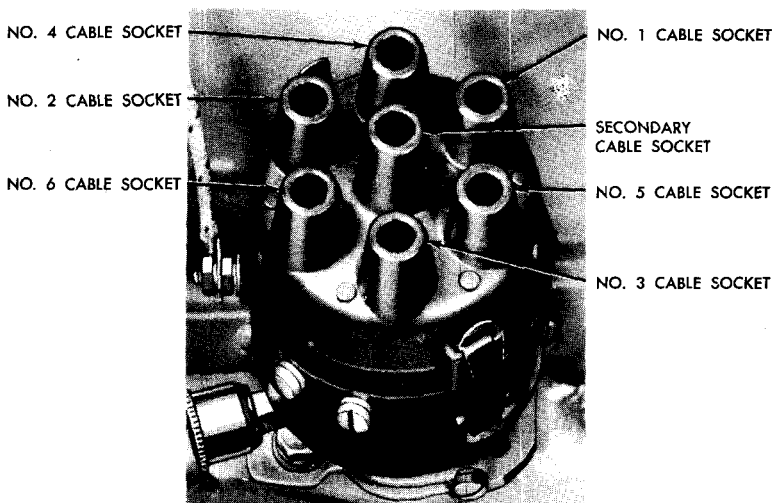

RA PD 332949

Figure 81—Plug Wire Sequence and Rotor Position

(fig. 76). Engine is then in No. 1 firing position. Position distributor rotor and insert as explained in step (1) above.

(3) CHECK OPERATING POSITION. It is important that a slight clearance be maintained between upper and lower ends of housing as shown in figure 82. When distributor is inserted into operating position, lower end of housing will contact drive gear. Before tightening clamp screw, place finger under the housing and thumb on rotor (fig. 82). While holding rotor down with the thumb, raise housing approximately 1/32 inch. Be sure to equalize clearance at top and bottom. Tighten clamp screw while distributor is in this position.

IGNITION SYSTEM

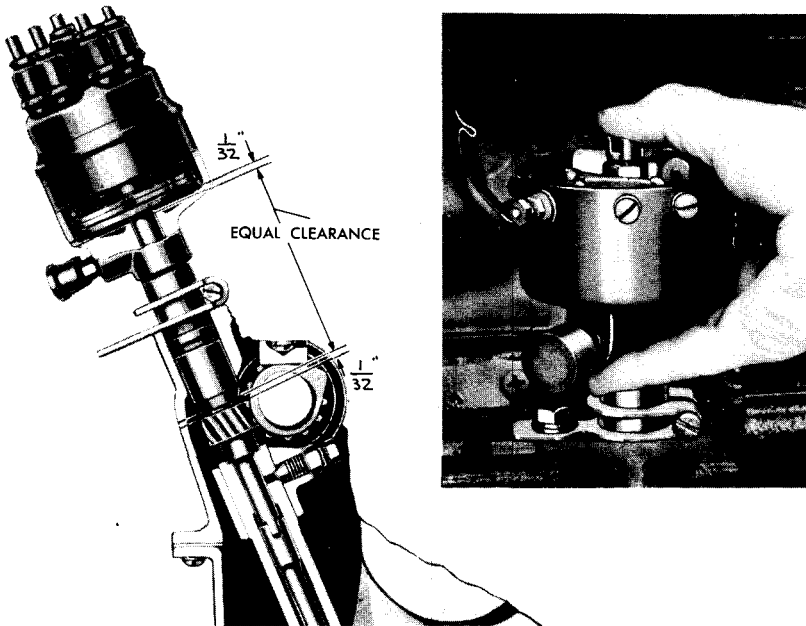

Figure 82—Distributor Operating Position

RA PD 333017

(4) **CHECK POINT OPENING.** Check point opening (subpar. **b** above). Install plug wires in correct sequence (1-5-3-6-2-4). Install secondary and primary wires to distributor.

(5) **CHECK INITIAL TIMING.** Check and adjust initial timing (par. 87 **b**), then adjust manual advance (par. 87 **c**).

89. SPARK PLUGS.

a. Removal. Remove spark plug wire assemblies from each spark plug. Use standard spark plug wrench when removing plugs (GM-1557987). Ordinary end wrenches may crack or damage porcelain.

b. Cleaning and Adjusting.

(1) **CLEAN SPARK PLUGS.** Spark plugs should be cleaned with standard sand blast cleaning equipment or with the use of dry-cleaning solvent. If points and porcelain are excessively burned, new spark plugs should be installed.

(2) **ADJUST POINT GAP.** Setting gap in a spark plug is a precision operation and should be treated as such. Proper gap provides 0.025 inch between side electrode and center electrode. When re-gapping is necessary, bend side electrode only, not center electrode. It is not only necessary to set gap properly, but all plugs should have same gap opening. Use a standard round feeler gage.

TRUCK, 2 1/2-TON, 6 x 6

c. **Installation.** Use new gasket [(GM-1556700) G122-0193970] and thread plug into cylinder head with fingers. Use standard spark plug wrench and tighten plug until it bottoms, then turn $\frac{1}{4}$ to $\frac{1}{2}$ turn until firm. Do not use extreme force in tightening the plug. It is not necessary to "crush" the gasket. Examine spark plug wires carefully and make certain that the suppressors at the plugs are tight and thoroughly cleaned. Install wires to the plugs and make sure they are fully seated in distributor cap in correct firing order (1-5-3-6-2-4).

90. IGNITION COIL.

a. Ignition coil is oil filled and hermetically sealed to prevent entrance of moisture. High tension terminal is protected by porcelain insulator which has high resistance to leakage across its surface and is not damaged by any leakage which might occur.

b. **Removal.** Remove nuts and lock washers at terminals and remove wires. Remove two nuts and internal-external toothed lock washers attaching coil bracket to cylinder head. Lift coil [(GM-1115149) G85-33-00861] up and remove secondary wire from terminal at bottom of coil.

c. **Installation.** Install secondary wire on terminal at bottom of coil. Position coil and install coil bracket over mounting studs and install nuts and internal-external toothed lock washers. Tighten nuts securely. Attach distributor terminal wire (No. 14 tan-red and black cross tracer) to negative (-) terminal and (No. 14 black) to positive (+) terminal. Tighten terminal nuts securely.

Section XVII**FUEL AND AIR INTAKE SYSTEM****91. DESCRIPTION AND OPERATION.**

a. **Description** (figs. 83 and 84). The fuel system comprises: fuel tank, fuel lines, fuel filter, fuel pump, carbureter, air cleaner, carbureter control linkage, and manifold heat control valve. Electrical gage system provides means of determining level of fuel in tank.

b. **Operation.** The fuel supply, stored in the fuel tank, is drawn through the fuel filter by action of the fuel pump. The fuel pump forces fuel, as required, to the carbureter where it is properly mixed with air drawn into the carbureter through an oil-bath type air cleaner. The mixture of air and fuel is drawn into the combustion chamber by the downward stroke of the piston. The manifold heat control valve provides a means in cold weather of bypassing exhaust heat around intake manifold to aid in vaporization and in hot weather directs exhaust heat away from intake manifold.

FUEL AND AIR INTAKE SYSTEM

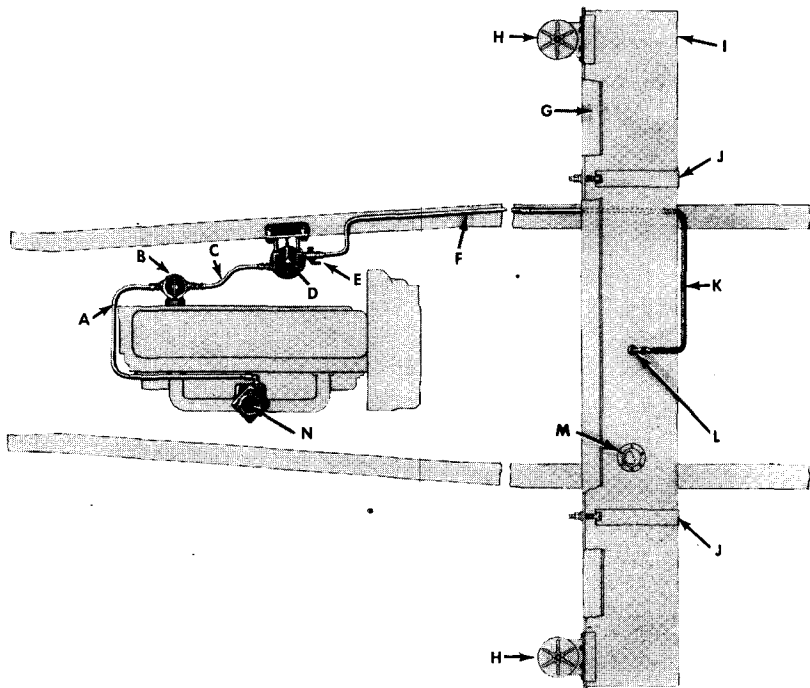

- A FUEL PUMP TO CARBURETER LINE
- B FUEL PUMP
- C FUEL FILTER TO FUEL PUMP HOSE
- D FUEL FILTER
- E SHUT-OFF COCK
- F FRAME CONNECTION TO FUEL FILTER FUEL LINE
- G TIRE CARRIER SUPPORT

- H FILLER CAP
- I FUEL TANK
- J FUEL TANK MOUNTING STRAP
- K FUEL TANK TO FRAME CONNECTION FUEL LINE
- L FUEL TANK OUTLET FUEL LINE
- M FUEL GAGE TANK UNIT
- N CARBURETER

RA PD 332995

**Figure 83—General Arrangement of Fuel System
Units—CCKW-352**

92. DATA.

a. Carbureter.

Make Zenith
 Type—Early vehicles Die cast
 Late vehicles Cast Iron
 Model—Early vehicles 28AV11
 Late vehicles 30 BW 11GM
 Identification—Early vehicles 2135998-9778B
 Late vehicles 2137474-10046

b. Fuel Pump—Make and model..... AC- AF

c. Fuel Filter—Make and model..... AC- T2

d. Fuel Tank—Capacity 40 gal

TRUCK, 2½-TON, 6 x 6

- e. Fuel Tank Filler Cap—Make AC
Pressure valve opens at (lb pressure per sq in.) . . . 1½ - 2½
Vacuum valve opens at (lb pressure per sq in.) . . . ½ or less
- f. Air Cleaner—Make AC
Type—Early vehicles Clamp on—oil bath
Late vehicles Flange mounted (high angle)—
oil bath

93. MANIFOLD HEAT CONTROL.

a. **Description.** The manifold heat control, located in the exhaust manifold, consists of a butterfly valve and an adjusting lever (fig. 85). The function of the valve is to direct the flow of hot exhaust gases through the manifolds to aid in the vaporization of the fuel.

b. **Adjustment.** The valve adjusting lever has two extreme positions indicated by "ON" and "OFF." A medium setting is obtained by adjusting the valve midway between "ON" and "OFF." Loosen valve adjusting lever lock nut; then back out slotted screw until it clears recess in manifold. Move lever to proper position to obtain desired setting of valve. Tighten slotted screw into manifold recess only enough to prevent valve from rattling. Tightening screw

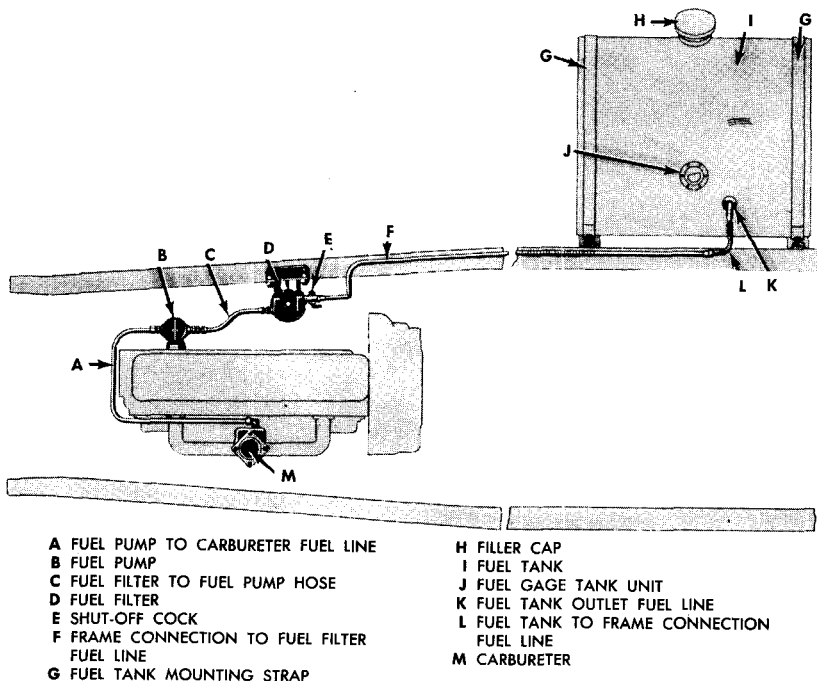

Figure 84—General Arrangement of Fuel System
Units—CCKW-353

RA PD 332996

FUEL AND AIR INTAKE SYSTEM

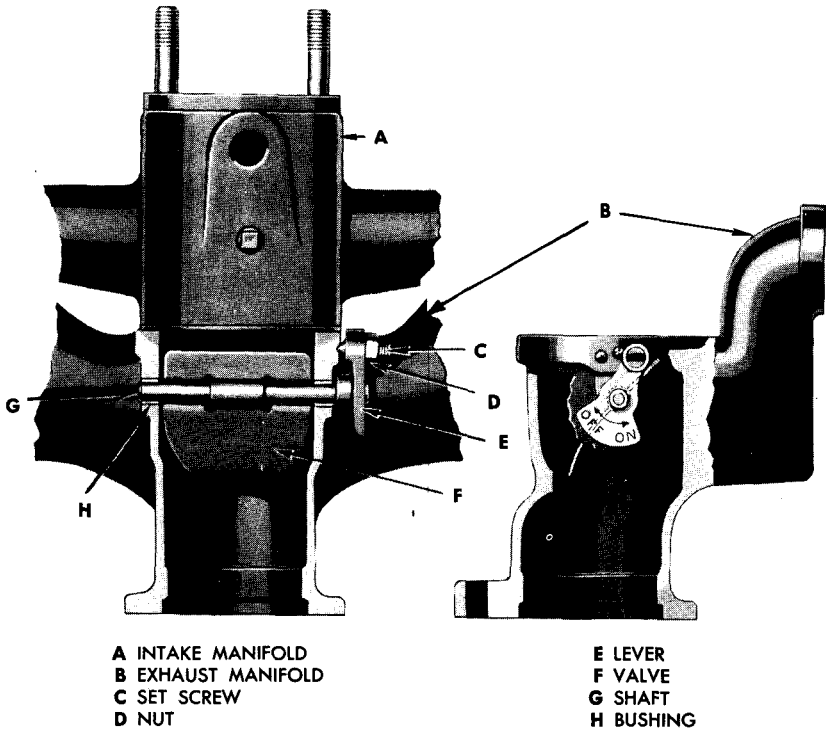

Figure 85—Manifold Heat Control

RA PD 332936

excessively may distort valve lever or shaft. Finally, tighten lock nut.

(1) **SUMMER OPERATION.** At air temperature of about 60° F and above, adjust valve to "OFF" position.

(2) **WINTER OPERATION.** At air temperature of about 30° F and below, adjust valve to "ON" position.

(3) **SPRING AND FALL OPERATION.** At air temperature of about 30° to 60° F and also at lower temperatures when in heavy duty operation (heavy loads, high speeds, and extensive operation in low speed gears), adjust valve to medium position. *NOTE: Medium position may be used whenever "OFF" position does not furnish sufficient heat or "ON" position supplies too much heat due to type of operation or weather conditions.* It is not expected that control valve setting will be changed every time conditions vary. However, valve should be set for average operating conditions consistent with air temperature.

94. CARBURETER.

a. **Description.** Two types of carbureters are used on vehicles covered by this manual, die cast and cast iron. Early vehicles were

TRUCK, 2 1/2-TON, 6 x 6

equipped with die cast carbureter; late vehicles with cast iron carbureter (fig. 87). Both are balanced units which maintain the proper depression ratio between the air intake of the carbureter and the fuel bowl. All fuel mixture adjustments, except idling, are determined by calibration of the various jets and cannot be changed without disassembling the carbureter and changing the jets.

b. Idling Speed Adjustment. Warm up engine until the intake manifold is at least warm to the hand (120° F or higher). Back stop screw, on carbureter throttle lever, out (turn to left) until engine runs evenly (rolls), then turn stop screw in (to right) until engine reaches desired idling speed of approximately 400 to 450 revolutions per minute.

c. Idling Mixture Adjustment. Warm up engine until intake manifold is at least warm to the hand (120° F or higher). Slow engine down to idling speed (subpar. **b** above). Disconnect windshield wiper tube from manifold fitting and attach a vacuum gage at manifold. Turn idling screw gradually to the right until vacuum reading starts to drop, then to the left until vacuum reading starts to drop. Note the number of turns made by idling screw and set screw at center of travel. This will give a steady vacuum reading at its highest point. If engine idles too fast after this adjustment is made, adjust idling speed again (subpar. **b** above) and repeat above procedure. Regulation of idling mixture in no way affects function of carbureter at higher speeds. Disconnect vacuum gage, and connect windshield wiper tube.

d. Removal Procedure.

(1) **DISCONNECT CHOKE CONTROL AND HAND THROTTLE.** Remove air cleaner (par. 99). Loosen clip screws at carbureter end of choke and throttle control flexible housings. Loosen carbureter choke lever swivel screw. Pull choke control wire and flexible housing from swivel and clip. Remove collar or stop from end of hand throttle control wire. Pull hand throttle control wire and flexible housing from carbureter control rod and clip. Remove carbureter control rod from throttle lever.

(2) **REMOVE CARBURETER.** Disconnect carbureter fuel line by unscrewing flange nut. Remove two nuts and lock washers (carbureter to manifold) and remove carbureter (GM-2135998 die cast, GM-2137474 cast iron) from vehicle.

e. Installation Procedure (fig. 86). When installing carbureter, be sure correct gasket is used between carbureter and governor. This gasket [(GM-2136304) G133-01-93852] must have slots in it to allow vacuum to bypass freely between carbureter and governor housings (fig. 86).

(1) **INSTALL CARBURETER.** Place gasket and carbureter in position over manifold studs. Install two stud lock washers and nuts, then seal forward nut with a new seal. Place carbureter fuel line in position in carbureter fitting and install flange nut.

(2) **ATTACH CHOKE CONTROL AND HAND THROTTLE.** Thread choke control flexible housing and wire through clip at carbureter.

FUEL AND AIR INTAKE SYSTEM

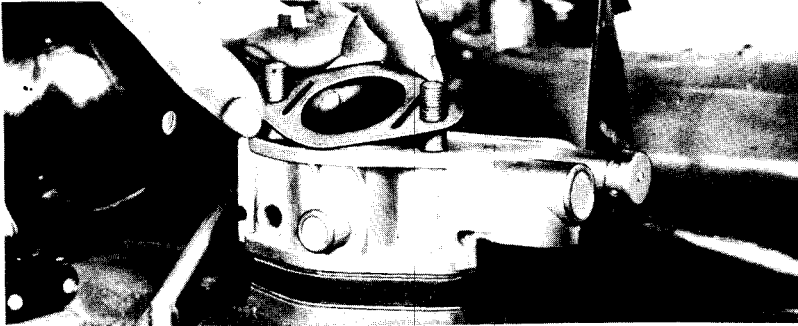

Figure 86—Carbureter to Governor Gasket

RA PD 64617

Insert wire through choke control swivel. Fasten end of flexible housing by tightening clip set screw then adjust choke control (par. 95). Thread hand throttle control wire and flexible housing through clip at carbureter. Install carbureter control rod through hole in throttle lever. Insert wire through hole in carbureter control rod. Fasten end of flexible housing by tightening clip set screw securely. Install collar or stop on control wire then adjust hand throttle (par. 95). Install air cleaner (par. 99).

95. CARBURETER CONTROLS.

a. Description. Carbureter controls consist of a hand choke control, [(GM-1990612) G501-01-39941] hand throttle [(GM-1990564) G501-01-39940], and accelerator pedal and linkage. For removal and installation of carbureter choke control and hand throttle at instrument panel, refer to subparagraphs **b** and **c** below.

b. Carbureter Choke Control (fig. 87).

(1) REMOVAL.

(a) Disconnect Choke Control at Carbureter. Loosen set screw which clamps wire in throttle lever swivel. Remove screw and clip which clamps end of flexible housing to bracket at carbureter. Pull end of wire through lever swivel. Remove bolt to loosen bond strap at cowl.

(b) Remove Choke Control. Unscrew nut from choke control at rear side of dash panel. Pull choke control from front side of dash panel until end of flexible housing and enclosed control wire are pulled through seal at cowl and hole in dash panel.

(2) INSTALLATION.

(a) Install Choke Control at Dash Panel. Insert end of flexible housing and enclosed control wire through hole in dash panel, place lock washer and nut over end of housing and enclosed wire, and insert end of wire and housing through seal at cowl. Push choke control button against dash and tighten in place with lock washer and nut at rear side of dash panel.

TRUCK, 2½-TON, 6 x 6

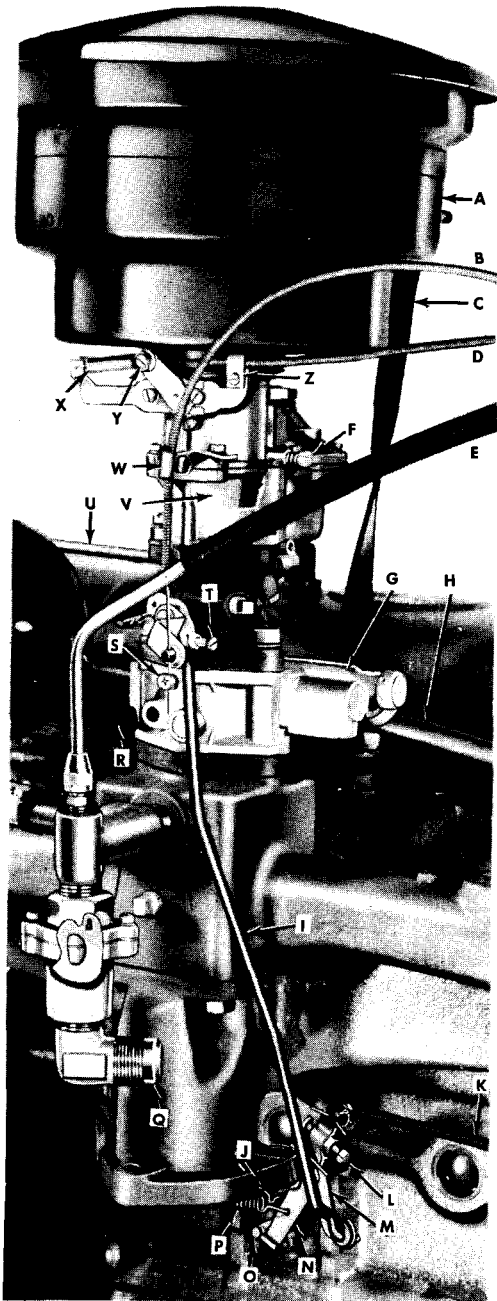

- A AIR CLEANER
- B HAND THROTTLE
- C AIR CLEANER BRACE
- D CHOKE CONTROL
- E WINDSHIELD WIPER TUBE
- F IDLING MIXTURE ADJUSTING SCREW
- G GOVERNOR
- H CYLINDER HEAD WATER BYPASS TUBE
- I CARBURETOR CONTROL ROD
- J ACCELERATOR RETURN SPRING —INNER
- K ACCELERATOR PEDAL TO CARBURETOR CONTROL LEVER ROD
- L CARBURETOR INNER CONTROL LEVER ADJUSTING SCREW
- M CARBURETOR OUTER CONTROL LEVER
- N CARBURETOR INNER CONTROL LEVER
- O CARBURETOR INNER CONTROL LEVER STOP
- P ACCELERATOR RETURN SPRING —OUTER
- Q BRAKE VACUUM LINE CONNECTION
- R CRANKCASE VENTILATOR TUBE
- S HAND THROTTLE STOP COLLAR
- T IDLING SPEED ADJUSTING SCREW
- U CARBURETOR FUEL LINE
- V CARBURETOR
- W HAND THROTTLE CLIP
- X CHOKE RETURN SPRING
- Y CHOKE CONTROL SWIVEL
- Z CHOKE CONTROL CLIP

RA PD 333007

Figure 87—Air Cleaner, Carburetor, and Controls Installed

FUEL AND AIR INTAKE SYSTEM

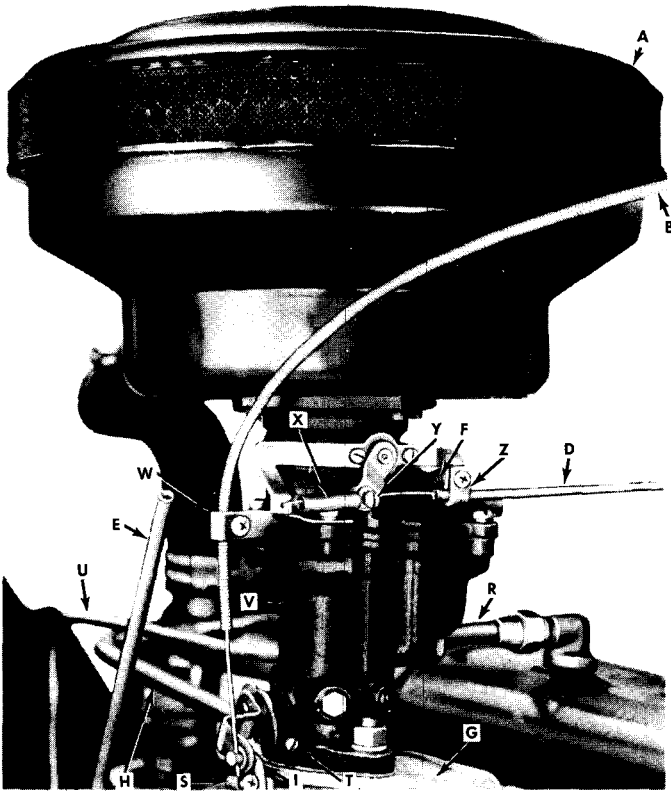

RA PD 333007B

Figure 87—Continued

(b) *Connect Choke Control at Carbureter.* Slide clip over end of wire and flexible housing and attach clip to bracket at carbureter with screw. Insert end of control wire through lever swivel. Tighten swivel set screw and clamp housing clip securely as described in step (3) below which covers this adjustment. Install bond strap to flexible housing at cowl.

(3) **ADJUSTMENT.** Tighten choke control lock nut behind instrument panel. Loosen swivel set screw at carbureter end of choke control wire. Adjust choke button so there is $\frac{1}{16}$ -inch clearance between button and instrument panel. Then with carbureter choke valve (air shutter) fully opened, that is, choke control lever tight against stop, tighten swivel set screw securely. Tighten flexible housing clamp screw.

c. **Hand Throttle** (fig. 87).

(1) **REMOVAL.**

(a) *Disconnect Controls at Carbureter.* Loosen set screw clamping stop collar on end of control wire at carbureter and remove stop

TRUCK, 2½-TON, 6 x 6

collar. Loosen screw which clamps flexible housing in clip at carbureter. Remove bolt to loosen bond strap at cowl.

(b) *Remove Throttle Control.* Unscrew nut from throttle control at rear side of dash panel. Pull throttle control from front side of dash panel until flexible housing and enclosed control wire are pulled through seal at cowl and hole in dash panel.

(2) INSTALLATION.

(a) *Install Throttle Control.* Insert end of flexible housing and enclosed control wire through hole in dash panel, place lock washer and nut over housing and enclosed wire, and insert end of wire and housing through opening in seal at cowl. Push throttle control into place against dash panel and tighten in place with lock washer and nut at rear of panel.

(b) *Connect Throttle Control at Carbureter.* Fit end of flexible housing into clip at carbureter. Insert end of control wire through hole in carbureter rod and install stop collar over end of wire. Tighten set screw after locating stop collar on control wire and clamp flexible housing in clip as described in step (3) below which describes this adjustment. Bolt bond strap to flexible housing at cowl.

(3) **ADJUSTMENT.** Tighten hand throttle lock nut behind instrument panel. Push in throttle button as far as it will go. Loosen throttle control wire stop collar set screw, and with carbureter throttle in closed position, that is, idling speed adjusting screw tight against stop, adjust stop collar so there is ¼ inch clearance between carbureter control rod and stop collar. Tighten collar set screw securely. Also, tighten flexible housing clamp screw.

d. Accelerator Pedal and Linkage Removal Procedure (fig. 87). Instructions given here are for removing accelerator pedal and linkage progressively beginning with accelerator pedal. These parts, however, may be replaced individually if so desired.

(1) **REMOVE PEDAL.** From driver's compartment remove cotter pin from pedal hinge pin then remove hinge pin from pedal and bracket. Remove pedal to control rod clevis pin and withdraw pedal from vehicle.

(2) **REMOVE PEDAL TO CARBURETER CONTROL LEVER ROD.** From engine compartment, remove cotter pin and washer from rod at carbureter control lever (mounted to left-hand side of cylinder block.)

(3) **REMOVE CARBURETER CONTROL LEVERS (AT CYLINDER BLOCK).** Remove control lever outer (lighter) return spring from end of inner control lever. Remove control lever inner (heavier) return spring from outer control lever. Remove cotter pin from lower end of outer control lever to carbureter rod and remove rod from control lever. Remove nut and washer from control lever mounting stud then remove both control levers.

(4) **REMOVE CARBURETER CONTROL LEVER TO CARBURETER ROD.** Loosen set screw in hand throttle control wire stop collar and remove stop collar. Withdraw wire from end of rod and remove rod from carbureter lever.

FUEL AND AIR INTAKE SYSTEM

e. Accelerator and Linkage Installation Procedure (fig. 87).

(1) **INSTALL CARBURETER CONTROL LEVERS (AT CYLINDER BLOCK).** From engine compartment, place inner control lever in position in outer control lever with extension pointing downward. Assemble both levers to mounting stud and install plain washer, lock washer, and nut. Hook return springs over cylinder block pin, heavier spring on inside, then hook heavier spring into outer control lever and lighter spring into inner control lever.

(2) **INSTALL CARBURETER CONTROL LEVER TO CARBURETER ROD.** Install rod through control lever (at carbureter) from engine side. Insert hand throttle control wire through end of rod and install stop collar, tightening screw firmly. Insert lower end of rod through outer control lever (at cylinder block) and install washer and cotter pin. Adjust inner control lever adjusting screw to provide approximately $\frac{1}{8}$ -inch clearance between end of screw and outer lever, then tighten lock nut. Adjust hand throttle (subpar. c above).

(3) **INSTALL PEDAL TO CARBURETER CONTROL LEVER ROD.** Insert pedal end of rod through hole in toe board. Insert bent end of rod through upper end of inner control lever. Install washer and cotter pin. Rod must not bind. Be sure it is installed to work freely.

(4) **INSTALL PEDAL.** In driver's compartment, attach pedal to toe board bracket with hinge pin. Install hinge pin so that cotter pin hole in pin will line up with hole in bracket on pedal. Insert cotter pin through hinge pin and bracket on pedal. Insert clevis pin through upper bracket on pedal and control rod, then secure with cotter pin.

96. GOVERNOR.

a. **Description.** A velocity type governor, mounted between the intake manifold and carbureter, is employed to protect the engine from being operated beyond a predetermined safe and economical speed. Although the governor does control the vehicle road speed, this is not its primary purpose.

b. **Removal.** Remove carbureter (par. 94), then lift governor from carbureter to manifold studs.

c. **Installation.** Care must be taken so that governor is not installed up-side-down as its position differs with downdraft and updraft carbureters. Governor is marked with an arrow indicating carbureter side. Also, the gasket used between the governor and carbureter incorporates two slots which allow vacuum to by-pass through the governor housing for operation of the carbureter power system. Be sure this gasket [(GM-2136304) G133-01-93854] is in good condition and installed between the governor and carbureter.

(1) **INSTALL GOVERNOR.** Place a new insulator to governor gasket (plain) [(GM-2135995) G501-01-94026] over carbureter to manifold studs, then place governor over studs so that arrow on governor points upward (toward carbureter). Install carbureter (par. 94).

d. **Cleaning Air Filter.** Carefully pry out metal cover with a sharp pointed punch. Be careful not to damage cast projections that

TRUCK, 2½-TON, 6 x 6

hold cover in place. Pick out filter felt and inner cover. Wash felt in dry-cleaning solvent and allow to dry. Do not blow dry with compressed air. Blow dirt from stabilizer cylinder and piston by directing compressed air, in sudden bursts, through atmospheric hole in governor air filter chamber. Moisten filter felt slightly with clean oil, then install inner cover, felt, and outer cover. It may be necessary to bend outer cover in order to install it, but it can be straightened again by tapping with a ball peen hammer after it is in position in governor housing.

e. Governor Adjustments. The correct governed speed of the engine is 2750 revolutions per minute (no load) with engine warmed up to normal operating temperature. Use a reliable tachometer (18-T-230) or if one is not available, check governed vehicle speed while driving on a level road with transfer case in high range and transmission in direct (4th speed). Set governor to maintain 37 miles per hour, plus or minus one mile per hour. This will give maximum engine speed of 2750 revolutions per minute. If road space or local speed limits prevent checking governor at 37 miles per hour, the next lower gear position may be used by referring to "Maximum Permissible Road Speed Plate" for correct speeds, however, governor setting will be more accurate at 37 miles per hour.

(1) **SPEED ADJUSTMENT.** To correct governed speed, break governor seal, then turn adjusting cap as necessary to obtain 2750 revolutions per minute maximum engine speed. One complete turn will alter vehicle speed from four to five miles per hour. Check governed speed by road test and when satisfactory, reseal governor.

(2) **CORRECTION OF SURGE.** Surge is the intermittent deceleration and acceleration of engine speed with the throttle held wide open. Adjustment for surge must be made only to the point of removing the surge. Over adjustment will result in slow governor opening. Wrench set (41-W-1496-695), comprising a hollow wrench and an Allen wrench, is required.

(a) Break governor seal and remove adjusting cap. Insert hollow wrench into adjusting screw housing and engage lugs in adjusting screw bushing. Insert Allen wrench into hole in hollow wrench, engaging Allen wrench in adjusting screw.

(b) Turn Allen wrench clockwise one complete turn, then hold Allen wrench from turning and turn hollow wrench clockwise ¼ turn or until surge is eliminated and engine runs steadily at 2750 revolutions per minute.

(c) Road test vehicle for elimination of surge. When satisfactory adjustment has been made, reseal governor.

(3) **CORRECTION OF SLOW GOVERNOR OPENING.** Slow governor opening is a decided loss in speed, when load is applied, while operating with wide open throttle. Correction is made in same manner as correction for surge, step (2) above, *except* turn wrenches *counterclockwise*. Make adjustment for slow governor opening very carefully as over adjustment will cause surge.

FUEL AND AIR INTAKE SYSTEM

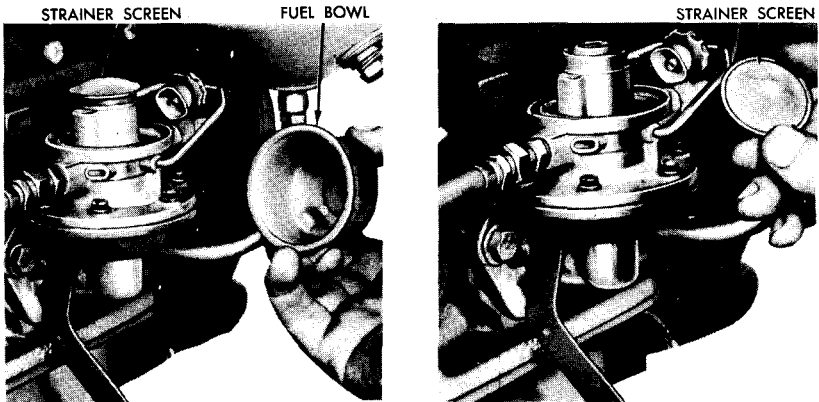

Figure 88—Servicing Fuel Pump

RA PD 332933

97. FUEL PUMP.

a. **Description.** The fuel pump [(GM-1537714) G85-30-04460] located at right-hand side of the engine, is a diaphragm type mechanically operated from the camshaft. In addition to camshaft operation while the engine is running, the pump is equipped with a hand operated lever which may be used to pump an initial supply of fuel into the carburetor in case the vehicle has run out of fuel, or the carburetor bowl has been emptied for any reason.

b. **Cleaning.** When pump fuel bowl and strainer screen are removed for cleaning, parts that are damaged or will not clean up must be replaced. Unscrew bowl clamp knurled nut, located at top of bowl, and move clamp so bowl can be removed. Lift bowl and strainer screen from pump (fig. 88) and thoroughly clean them with dry-cleaning solvent. Be sure that strainer screen [(GM-1523099) G85-30-04880] and bowl gasket [(GM-1523096) G85-30-02220] are in good condition; replace if necessary. Install strainer screen and bowl. Position bowl clamp over bowl and tighten knurled nut snugly.

c. **Fuel Pump Tests.** Fuel pump may be given capacity and pressure tests to determine correct operation. These two tests are separate and distinct from each other, and must be made with the pump mounted on the engine. Tests should be made before the pump is overhauled or replaced to determine condition of the unit.

(1) **CAPACITY TEST.** This test is to determine that a sufficient amount of fuel is flowing. Disconnect the fuel pump to carburetor line and attach a suitable bleeder hose to fuel pump outlet so that fuel may be caught in a container. With outlet of bleeder hose at carburetor level or slightly higher, flow of fuel should be approximately one pint in not over one minute operation of engine at 2000 to 2500 revolutions per minute (no load).

TRUCK, 2½-TON, 6 x 6

(2) **PRESSURE TEST.** Pressure test can be obtained with a standard fuel pump pressure gage attached to outlet of fuel pump. Pressure should be 3¾ pounds maximum at lowest idling speed of engine.

(3) **ANALYSIS OF TESTS.** If tests show a pressure not to exceed maximum (3¾ pounds) and at least the minimum flow in capacity, fuel pump operation can be considered as normal.

d. Removal Procedure (fig. 89).

(1) **DISCONNECT FUEL AND OIL LINES.** Disconnect fuel inlet hose [(GM-2123238) G501-02-17831] and outlet tube at pump, also oil return line at fuel pump forward mounting stud. Forward mounting stud is a special hollow stud to provide an oil return into crankcase.

(2) **REMOVE PUMP.** Remove forward mounting stud, also rearward cap screw, then remove pump from vehicle. Remove pump inlet and outlet fuel line connectors for installation in replacement pump.

e. Installation Procedure.

(1) **INSTALL PUMP.** Install inlet and outlet fuel line connectors in pump. Place pump in position on engine, using a new mounting gasket [(GM-838263) G104-15-93832] and install special hollow mounting stud, with copper washer, in forward position (fig. 89) and cap screw, with copper washer, in rearward position.

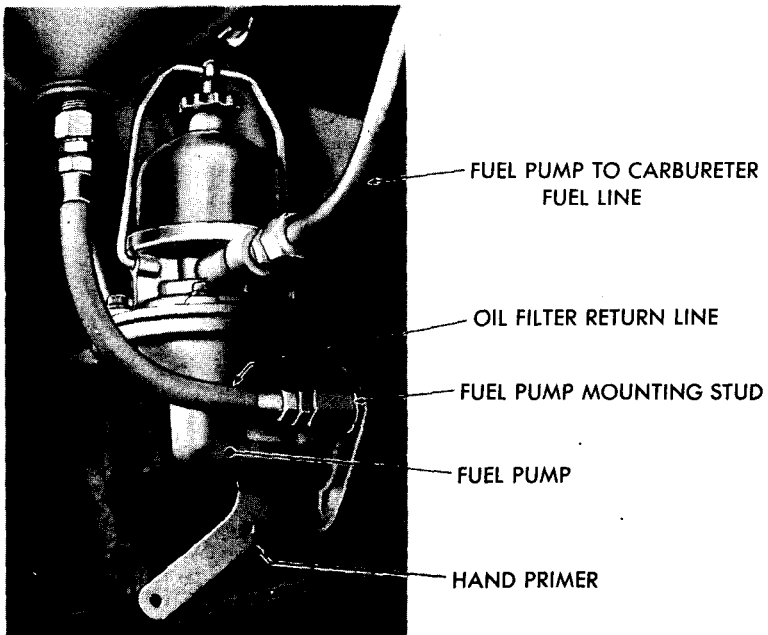

Figure 89—Fuel Pump Installed

RA PD 64610

FUEL AND AIR INTAKE SYSTEM

(2) **CONNECT FUEL AND OIL LINES.** Connect pump inlet and outlet fuel lines; also oil return line to special hollow stud. Test pump for efficient operation (subpar. c above).

98. FUEL FILTER.

a. Description. The fuel filter (fig. 90) comprises a disk type (laminated) strainer and is mounted on the right-hand frame side rail.

b. Cleaning.

(1) **REMOVE SHELL AND STRAINER.** Close fuel line shut-off cock at fuel filter. Remove drain plug and allow fuel to drain from filter. Unscrew cover screw and remove filter shell with strainer. Do not lose gaskets.

(2) **CLEAN FILTER.** Lift strainer and spring from shell and clean all parts thoroughly in dry-cleaning solvent. Be sure all particles are removed from between disks of strainer. *NOTE: Moderate air pressure may be used on brass strainers but must not be used when cleaning paper strainers. Wipe shell dry with a clean cloth.*

(3) **INSTALL STRAINER AND SHELL.** Inspect strainer gasket, cover gasket, and cover screw gasket. Replace with new parts (GM-2185916-Set) if found not to be in good condition. Place spring and strainer over stem in shell. With strainer and cover gaskets in position, assemble shell to cover; then install cover screw, with gasket,

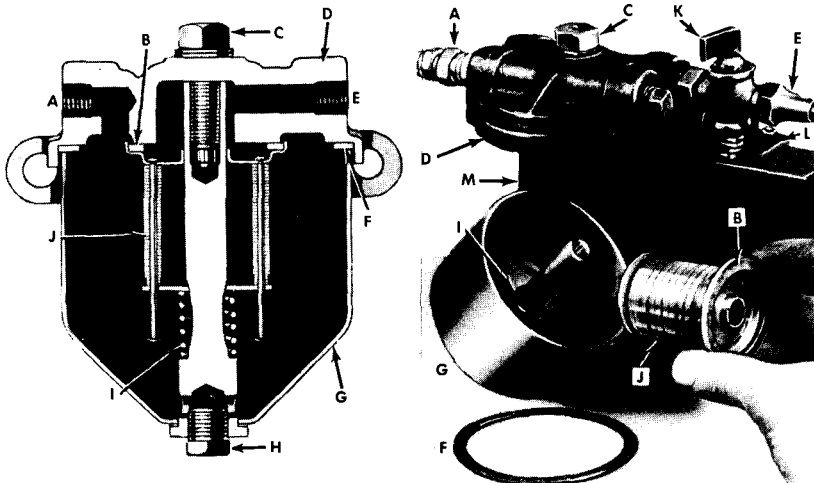

- A FUEL OUTLET
- B FILTER STRAINER GASKET
- C COVER SCREW
- ▷ COVER
- E FUEL INLET
- F COVER GASKET
- G SHELL

- H DRAIN PLUG
- I SPRING
- J FILTER STRAINER
- K SHUT-OFF COCK
- L FILTER MOUNTING BRACKET
- M FRAME SIDE RAIL

Figure 90—Fuel Filter—Assembled and Disassembled

RA PD 332895

TRUCK, 2 1/2-TON, 6 x 6

and tighten screw sufficiently to prevent leaks. Install drain plug.

c. **Removal.** Remove drain plug and allow fuel to drain from filter. Disconnect inlet and outlet fuel lines at filter. Remove two filter to mounting bracket bolts and remove filter from vehicle. Unscrew shut-off cock and outlet line connector from filter for installation in replacement filter.

d. **Installation.** Install shut-off cock in cover opening marked "IN" and connector in opening marked "OUT." Place filter in position on mounting bracket and install two mounting bolts, lock washers, and nuts. Connect inlet and outlet fuel lines, tightening flange nut enough to prevent leaks. Be sure drain plug and cover screw are tight enough to prevent leaks and that shut-off cock is in open position.

99. AIR CLEANER.

a. **Description.** The oil bath cleaner (fig. 91) is designed to prevent dust and dirt from entering carburetor. Air entering the cleaner passes into the oil chamber. Due to impact and sudden reversal of air flow, most all of the dirt in the air is thrown into the oil and settles to the bottom of the oil reservoir. Partially cleaned air passes through a dense oil saturated mesh where the remaining dust is trapped.

b. **Removal (Clamp-on Type Air Cleaner).** Loosen bolt nut that attaches air cleaner brace to air cleaner. Loosen clamp bolt that clamps air cleaner to carburetor and lift cleaner from top of carburetor.

c. **Removal (Flange Mounted Air Cleaner).** Unscrew wing

nut, at center of cleaner cover, and lift cleaner shell with element and cover as an assembly from cleaner center tube. Remove four cap screws, securing cleaner tube to carburetor, and remove tube from top of carburetor.

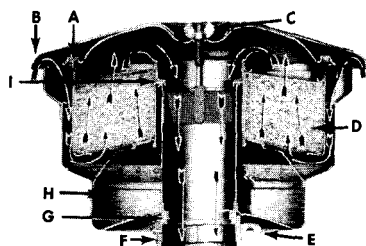

EARLY TYPE

- A COVER GASKET
- B COVER
- C WING NUT
- D FILTER ELEMENT
- E CLAMP
- F CLAMP SEAL
- G THROAT GASKET
- H OIL RESERVOIR

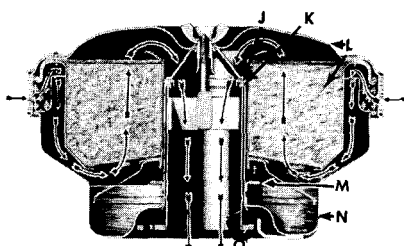

LATE TYPE

- I GASKET
- J GASKET
- K GASKET
- L COVER AND ELEMENT ASSEMBLY
- M OIL LEVEL INDICATOR
- N OIL RESERVOIR
- O FLANGE AND TUBE

FUEL AND AIR INTAKE SYSTEM

d. **Cleaning.** Dust and dirt in the air entering air cleaner is loaded with minute particles of abrasive which, if permitted to enter the engine, will cause rapid wear of moving parts. Importance of keeping the air cleaner in proper condition should be impressed upon those responsible for the mechanical upkeep of the engine. Remove air cleaner and clean as directed in Lubrication, Section VIII. Condition of air cleaner cover gasket [(GM-1526517) G104-15-93762 for clamp-on type] should be checked and replaced if necessary.

e. **Installation (Clamp-on Type Air Cleaner).** Inspect cleaner to carbureter gasket and cleaner clamp seal. Make sure they are in place and in good condition, that is, they will form a good seal. Replace with new parts if necessary. If rustproofing oil is on new parts, remove the oil with dry-cleaning solvent and wipe seal dry with a clean cloth. Air cleaner to carbureter adapter must not be bent or distorted. Straighten if necessary. Be sure cleaner is clean and oil is at proper level.

(1) **INSTALL CLEANER.** Place cleaner in position on top of carbureter, directing cleaner brace bolt into notch at top of brace. Press down on cleaner to compress cleaner to carbureter gasket, and hold it down firmly while tightening clamp bolt. Tighten air cleaner to brace bolt nut firmly.

f. **Installation (Flange Mounted Air Cleaner).** If unit to be installed is assembled, unscrew wing nut and lift shell and cover with element from center tube. Inspect cleaner shell to tube gasket and element to shell gasket. Make sure they are in place and in good condition, that is, they will form a good seal. Replace with new parts if necessary. Be sure cleaner is clean and oil is at proper level.

(1) **INSTALL CLEANER.** Place cleaner tube in position on top of carbureter, using a new gasket, and install four tube to carbureter cap screws with lock washers. Place shell over tube and turn it as necessary to engage bracket with flat of carbureter flange; then place element and cover into position in shell. Thread wing nut onto stud and tighten snugly.

100. FUEL TANK AND LINES.

a. **Fuel Tank Description.** The fuel tank is located in one of two positions, depending upon wheelbase of vehicle. The tank on 145-inch wheelbase vehicles (CCKW-352) is mounted across the frame at rear of cab inside of the tire carrier support (fig. 83). Tank is held securely in place by two mounting straps. Two filler necks are provided, one at each end of the tank, so that the tank may be filled from either side of the vehicle. The tank on 164-inch wheelbase vehicles (CCKW-353) is mounted on the frame right-hand side rail just back of the cab (fig. 84). Tank is held securely in place by two mounting brackets and two mounting straps. One filler neck is provided which incorporates an extension to be used when the tank is filled from a container. Filler cap (GM-850164) (fig. 92) is pressure type, incorporating a spring loaded pressure (relief) valve and a

TRUCK, 2½-TON, 6 x 6

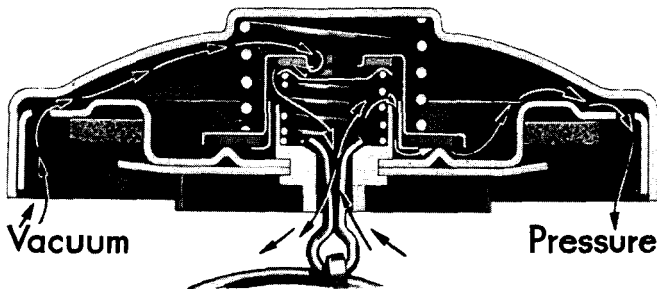

RA PD 332847

Figure 92—Fuel Tank Filler Cap

spring loaded vacuum (intake) valve. This type cap completely seals end of filler neck, thus preventing fuel, in both liquid and vapor form, from being lost. Valves open only to relieve excessive pressure or vacuum, whichever condition prevails.

b. Fuel Tank Removal Procedure (145-Inch Wheelbase Vehicles).

(1) **DRAIN TANK.** Unscrew two drain plugs from bottom of tank (located at center and left-hand end). Allow fuel to drain from tank. Do not replace drain plugs as they will interfere with tank removal.

(2) **REMOVE FUEL TANK GAGE UNIT.** Remove five screws and lock washers and remove gage unit from tank.

(3) **REMOVE FUEL TANK OUTLET LINE.** Unscrew fuel line flange nut (at tank) and disconnect fuel line. Unscrew fuel tank outlet line retaining nut and pull outlet line from fuel tank. This is necessary to provide clearance for tank removal.

(4) **REMOVE TWO FUEL TANK FILLER NECKS.** Remove filler neck to tank cap screws and lock washers (six at each filler neck) and remove filler necks from tank.

(5) **REMOVE TANK.** Back off nuts at forward end of each mounting strap as far as possible, but do not remove them. Remove nut and washer from lower end of each mounting strap. Lift mounting straps away from tank, using a suitable bar, and withdraw tank from end of tire carrier support.

c. Fuel Tank Installation Procedure (145-Inch Wheelbase Vehicles).

(1) **INSTALL TANK.** Make sure that fuel tank mounting bracket antisqueak strips are in good condition and in place (install new ones if necessary), then move fuel tank into position in tire carrier support. Positioning of tank may be simplified by using a screw driver or other suitable tool to guide tank past mounting straps. Tighten nuts at forward end of each mounting strap enough to position mounting strap on tank, then install washer and nut at lower end of mounting straps and tighten them securely.

(2) **INSTALL FILLER NECKS.** Install two fuel tank filler necks to fuel tank, using a new gasket between filler neck and tank. Install

FUEL AND AIR INTAKE SYSTEM

cap screws with lock washers (six at each filler neck) and tighten securely.

(3) **INSTALL FUEL TANK OUTLET LINE.** Place fuel tank outlet line in position in tank. Be sure lower end of line engages hole in support at bottom of tank. Install outlet line retaining nut and tighten securely.

(4) **CONNECT FUEL LINE.** Install fuel line in fuel tank outlet line connection and tighten flange nut securely.

(5) **INSTALL FUEL TANK GAGE UNIT.** Place gage unit in position in tank, using a new gasket [(GM-1516061) G501-01-94010] and install five gage unit to tank screws with new gaskets under heads of screws.

(6) **CONNECT FUEL GAGE WIRE.** Install gage unit wire over gage unit terminal and install lock washer and nut. Install rubber protector over terminal.

(7) **INSTALL FUEL TANK DRAIN PLUGS.** Install two fuel tank drain plugs (at center and left-hand end of tank) and tighten securely to prevent fuel leakage.

d. Fuel Tank Removal Procedure (164-Inch Wheelbase Vehicles).

(1) **DRAIN TANK.** Unscrew drain plug from bottom of tank and allow fuel to drain from tank.

(2) **DISCONNECT FUEL GAGE WIRE.** Remove rubber protector from gage unit wire terminal and remove nut and lock washer. Then remove wire from terminal.

(3) **DISCONNECT FUEL LINE.** Unscrew fuel line flange nut (at tank) and disconnect fuel line.

(4) **REMOVE FUEL TANK.** Remove two mounting strap to mounting bracket bolt nuts and lock washers. Remove two mounting strap hinge pin cotter pins and remove hinge pins. Lift mounting straps from vehicle and tank is free to be lifted from mounting brackets.

(5) **REMOVE CAP AND FILLER NECK EXTENSION.** Remove filler cap. Pull extension out of filler neck as far as possible. Turn extension counterclockwise and continue to pull extension from filler neck.

(6) **REMOVE FUEL TANK OUTLET LINE.** Unscrew fuel tank outlet line retaining nut and remove outlet line from tank.

(7) **REMOVE FUEL TANK GAGE UNIT.** Remove five gage unit to tank screws and gaskets and remove gage unit from tank.

e. Fuel Tank Installation Procedure (164-Inch Wheelbase Vehicles).

(1) **INSTALL FUEL TANK OUTLET LINE.** Place fuel tank outlet line in position in tank. Be sure lower end of line engages hole in support at bottom of tank. Install outlet line retaining nut and tighten securely.

(2) **INSTALL FUEL TANK GAGE UNIT.** Place gage unit in position in tank, using a new gasket, and install five gage unit to tank screws with new gaskets under heads of screws.

(3) **INSTALL FUEL TANK DRAIN PLUG.** Install fuel tank drain plug and tighten securely to prevent fuel leakage.

TRUCK, 2½-TON, 6 x 6

(4) **INSTALL FUEL TANK.** Make sure fuel tank mounting bracket antisqueak strips are in position, then place tank in position on mounting brackets. Position fuel tank mounting straps and install two hinge pins. Secure hinge pins with cotter pins. Install mounting strap bolts through mounting brackets and install lock washers and nuts. Tighten nuts securely to prevent any movement of tank.

(5) **CONNECT FUEL LINE.** Install fuel line in fuel tank outlet line connection and tighten flange nut securely.

(6) **CONNECT FUEL GAGE WIRE.** Install gage unit wire over gage unit terminal and install lock washer and nut. Install rubber protector over terminal.

f. Fuel Lines.

(1) **DESCRIPTION.** Special metal fuel lines, covered with protective looms wherever necessary, extend between the fuel tank and carbureter. Flexible hose is provided between the fuel filter and fuel pump to eliminate the possibility of fuel line breakage. A shut-off cock is provided at the fuel filter for convenience when performing service operations on the system.

(2) **REPLACEMENT.** Fuel lines are securely fastened in position with clips and may be readily removed or installed. Refer to figures 83 and 84 for relative positions and accessibility of various lines. Always install new lines in same position as that occupied by the lines they are replacing.

101. FUEL GAGE TEST.

a. To simplify testing of fuel gage, it is recommended that tank be approximately one-half full to prevent gage from normally reading "FULL" or "EMPTY." Refer to figure 93.

b. **If Gage is Dead.** If gage is dead (that is, hand remains to

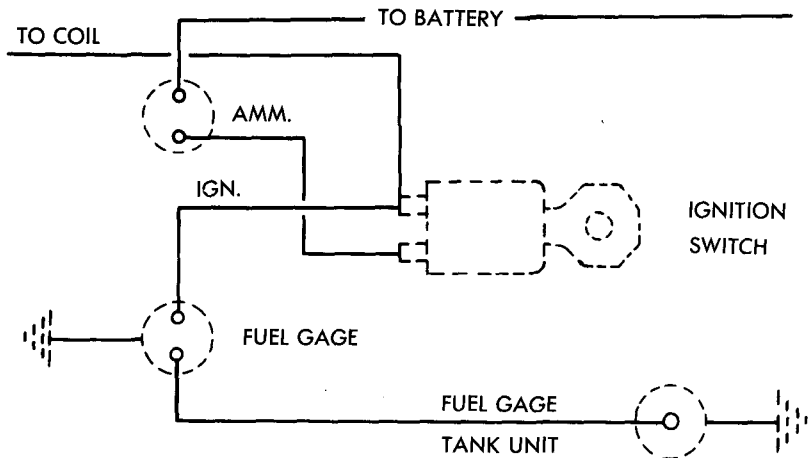

RA PD 332998

Figure 93—Fuel Gage Circuit Diagram

FUEL AND AIR INTAKE SYSTEM

left of empty) when ignition switch is turned on, current is not reaching gage. To test, connect a jumper wire from "IGN" terminal of gage to either terminal of ignition switch. If gage registers, wire from ignition switch to gage is defective and must be repaired or replaced (par. 128). *NOTE: Early vehicles incorporate a circuit breaker in the circuit between ignition switch and gage. In the event the above test shows this circuit defective, install a new wire from ignition switch direct to "IGN" terminal of gage.*

c. **If Gage is Stuck.** If gage remains in any one position (other than dead) as ignition switch is turned on and off, gage is defective or tank unit float is stuck. To test, ground tank unit terminal with a jumper wire or screw driver; if gage shows "EMPTY," replace tank unit [(GM-1515435) G508-01-93761] (par. 100); if gage does not move, replace gage (par. 140).

d. **If Gage Registers Incorrectly.** If gage registers when ignition switch is turned on, but is known to register incorrectly, this indicates that tank unit float arm is bent or distorted and tank unit must be replaced (par. 100).

e. **If Gage Registers Empty.** If gage registers "EMPTY" when ignition switch is turned on, wire from gage to tank is shorted and must be repaired or replaced (par. 128).

f. **If Gage Registers Full.** If gage registers "FULL" when ignition switch is turned on, wire from gage to tank unit is broken or tank unit is defective. To determine which, ground tank unit terminal with a jumper wire or screw driver. If gage then shows "EMPTY," replace tank unit (par. 100); if gage still shows "FULL," repair or replace gage to tank unit wire (par. 128).

Section XVIII

EXHAUST SYSTEM

102. DESCRIPTION.

a. Exhaust system (figs. 94 and 95), consists of an exhaust pipe, muffler, tail pipe, and attaching parts. The function of the exhaust system is to carry away engine exhaust gases and to muffle engine combustion noises. Two types of exhaust systems are used on vehicles covered by this publication. On vehicles equipped with heated water tanks, the exhaust system differs from the conventional exhaust system in that the exhaust pipe is insulated and an exhaust by-pass valve is installed ahead of the muffler to direct the exhaust gases through the water tank heater box.

103. EXHAUST PIPE.

a. **Conventional System** (fig. 94). The exhaust pipe extends from the exhaust manifold to the muffler and is attached to the

TRUCK, 2½-TON, 6 x 6

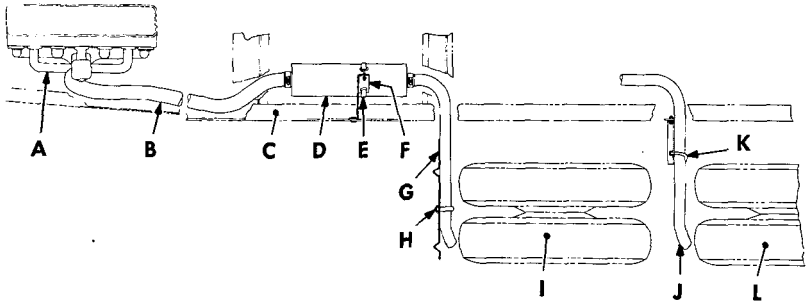

- A MANIFOLD
- B EXHAUST PIPE
- C FRAME SIDE RAIL
- D MUFFLER
- E MUFFLER STRAP
- F MUFFLER SUPPORT BRACKET
- G TAIL PIPE (145-INCH WHEELBASE)

- H U-BOLT
- I FORWARD REAR WHEELS (145-INCH WHEELBASE)
- J TAIL PIPE (164-INCH WHEELBASE)
- K U-BOLT
- L FORWARD REAR WHEELS (164-INCH WHEELBASE)

Figure 94—Exhaust System (All Vehicles Except Heated Water Tank)

RA PD 64692

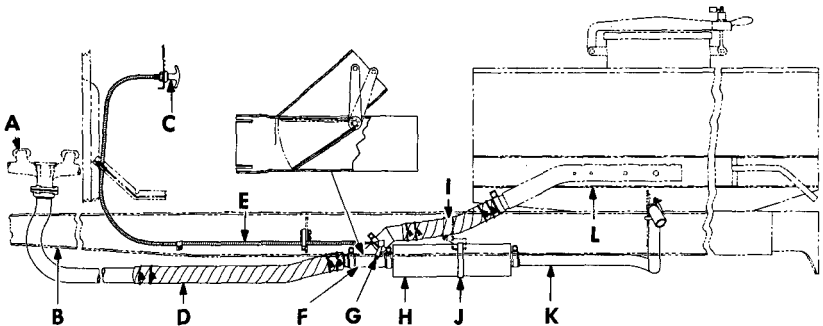

- A EXHAUST MANIFOLD
- B FRAME SIDE RAIL
- C EXHAUST BYPASS VALVE CONTROL WIRE
- D EXHAUST PIPE AND INSULATION ASSEMBLY
- E EXHAUST BYPASS VALVE CONTROL WIRE
- F EXHAUST BYPASS VALVE ASSEMBLY

- G EXHAUST BYPASS VALVE CONTROL LEVER
- H MUFFLER
- I EXHAUST BYPASS VALVE TO WATER TANK HEATER BOX TUBE
- J MUFFLER STRAP
- K TAIL PIPE
- L WATER TANK HEATER BOX

Figure 95—Exhaust System (Heated Water Tank)

RA PD 332952

EXHAUST SYSTEM

manifold by three bolts, nuts and lock nuts. This connection is sealed by a gasket and flange seal (fig. 96). The rear end of the exhaust pipe is inserted in the front end of the muffler and held in place by a clamp.

b. **Heated Water Tank System** (fig. 95). The exhaust pipe is insulated to retain the heat in the system, and is attached and sealed at the manifold in the same manner as the conventional system (fig. 96). The rear end of the exhaust pipe is inserted in the forward end of the exhaust by-pass valve assembly and attached with a clamp.

c. **Exhaust Pipe Removal** (figs. 94, 95, and 96). Loosen clamp attaching rear end of exhaust pipe to muffler or exhaust by-pass valve assembly, as the case may be. Remove lock nuts and nuts from three bolts attaching exhaust pipe flange to manifold. Remove bolts. Move exhaust pipe forward far enough to pull rear end out of muffler or exhaust by-pass valve assembly, and remove from under vehicle.

d. **Exhaust Pipe Installation** (figs. 94, 95, and 96). Make certain clamp is in place on forward end of muffler or exhaust by-pass valve, as case may be. Install exhaust pipe flange on exhaust pipe. From underneath vehicle, insert the upper end of exhaust pipe between engine and frame side rail, then insert rear end of exhaust pipe into muffler or exhaust by-pass valve. Position exhaust pipe flange, seal, and gasket (GM-2017499). Insert three bolts up through the exhaust pipe flange, seal, gasket, and manifold shown in figure 96. Install nuts on bolts and tighten alternately. Install lock nuts. Tighten clamp bolt at rear end of exhaust pipe.

104. MUFFLER AND TAIL PIPE.

a. The muffler is supported from frame side rail by a support bracket and strap. The tail pipe is attached to the muffler by a clamp. The outer end of the tail pipe is supported at the splash

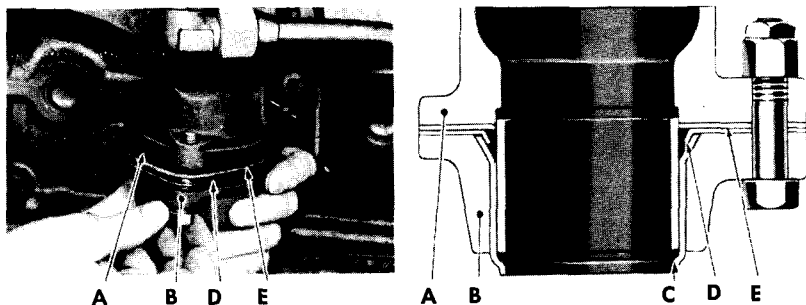

A MANIFOLD
B EXHAUST PIPE FLANGE
C EXHAUST PIPE

D EXHAUST PIPE FLANGE SEAL
E EXHAUST PIPE FLANGE GASKET

Figure 96—Exhaust Pipe to Manifold Connection

RA PD 64621

TRUCK, 2½-TON, 6 x 6

shield by a U-bolt on the conventional exhaust system (fig. 94) and by a clip bolt on the heated water tank exhaust system (fig. 95). Two different length tail pipes are used on the conventional system, depending on the wheelbase of the vehicle.

b. Muffler and Tail Pipe Removal (figs. 94, 95, and 97).

(1) **REMOVE TAIL PIPE.** Loosen clamp attaching tail pipe to muffler. Remove U-bolt or clip bolt, as the case may be, attaching tail pipe to splash shield, then pull tail pipe out of rear end of muffler.

(2) **REMOVE MUFFLER.** Loosen clamp attaching exhaust pipe or exhaust by-pass valve assembly, as the case may be, to muffler. Remove nut and lock washer from muffler strap bolt and pull bolt out of bracket. Move muffler toward rear of vehicle to pull it off exhaust pipe or exhaust by-pass valve and remove from under vehicle.

c. Muffler and Tail Pipe Installation (figs. 94, 95, and 97).

(1) **INSTALL MUFFLER.** Make sure clamp is in place on forward end of muffler and slide end of muffler over end of exhaust pipe or exhaust by-pass valve assembly, as the case may be. Hold muffler against muffler support bracket and wrap muffler strap around muffler, then insert muffler strap bolt into muffler support bracket. Install nut and lock washer on bolt but do not tighten until after tail pipe is installed.

(2) **INSTALL TAIL PIPE.** Make sure clamp is in place on rear end of muffler, then insert forward end of tail pipe into muffler. Attach outer end of tail pipe to splash shield with U-bolt or clip bolt and tighten securely. Position muffler until the ends of exhaust pipe and

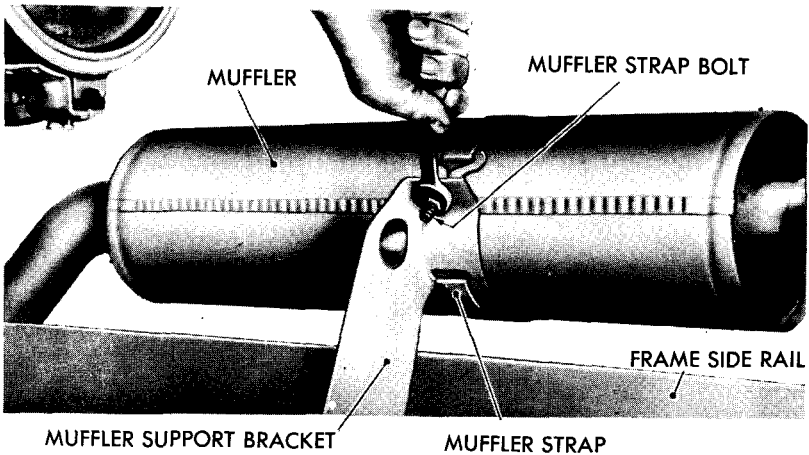

Figure 97—Muffler to Frame Mounting

RA PD 64606

EXHAUST SYSTEM

tail pipe are each inserted an equal distance into the muffler. Tighten the clamp bolt at each end of the muffler, then tighten the muffler strap bolt.

105. EXHAUST BY-PASS AND CONTROL (WATER TANK BODY).

a. The exhaust by-pass valve is installed between the exhaust pipe and muffler, and is held in place by clamps. It directs the exhaust gases, through an insulated tube, to the water tank heater box and is operated manually by a control installed on the dash panel to the left of the steering wheel.

b. **Exhaust By-Pass Valve and Water Tank Heater Box Tube Removal (fig. 95).**

(1) **DETACH MUFFLER.** Remove nut and lock washer from tail pipe clip bolt. Loosen clamp at forward end of muffler. Loosen muffler strap bolt and move muffler and tail pipe assembly toward rear of vehicle.

(2) **REMOVE EXHAUST BY-PASS VALVE AND WATER TANK HEATER BOX TUBE ASSEMBLY.** Remove cotter pin and plain washer from swivel and remove it from by-pass valve control lever. Loosen clamp attaching water tank heater box tube to heater box inlet, also clamp attaching exhaust by-pass valve to exhaust pipe. Remove exhaust by-pass valve assembly from exhaust pipe, then pull down and forward to remove water tank heater box tube off water tank heater box inlet. Remove assembly from under vehicle. Remove water tank heater box tube from exhaust by-pass valve assembly by loosening the attaching clamp.

c. **Exhaust By-pass Valve and Water Tank Heater Box Tube Installation (fig. 95).**

(1) Install clamp on lower end of water tank heater box tube, then position tube on exhaust by-pass valve assembly and tighten clamp bolt. Install clamp on upper end of water tank heater box tube, and slip tube over water tank heater box inlet. Install clamp on forward end of exhaust by-pass valve assembly, then position assembly over rear end of exhaust pipe.

(2) **ATTACH MUFFLER.** Install muffler and tail pipe assembly over rear end of exhaust by-pass valve assembly. Tighten muffler strap bolt. Install tail pipe clip bolt, nut, and lock washer and tighten securely. Tighten clamp bolts at both ends of exhaust by-pass valve assembly, and at upper end of water tank heater box tube.

(3) **ADJUST AND CONNECT EXHAUST BY-PASS VALVE CONTROL WIRE.** Push control button in driver's compartment "in." Hold valve lever on exhaust by-pass assembly in rearward position, then screw swivel on or off control wire until swivel shaft will fit into control lever freely. Install plain washer and cotter pin.

TRUCK, 2½-TON, 6 x 6

Section XIX

COOLING SYSTEM

106. DESCRIPTION.

a. The cooling system is of the sealed type and comprises the following units: drive belt, fan, radiator, thermostat, water pump, temperature gage, pressure type filler cap, cylinder head water by-pass tube, and the tubes, hose and fittings connecting the radiator to the engine and water pump. These units, when given proper maintenance, automatically control engine operating temperature. Water is drawn from the bottom of the radiator by action of the water pump and is force-circulated through the passages and water jackets in the engine and returned, through the upper connection, to the radiator where it is cooled by the action of the fan drawing air through the radiator core. A pressure cap (on radiator) maintains a pressure of approximately four pounds in the cooling system when the engine is warmed up to normal operating temperature. The temperature gage, capillary tube, and thermal unit are fabricated as an assembly. No provisions are made to repair this unit. In the event the gage fails to function properly, replace with one known to be in good condition (par. 139).

107. SERVICE.

a. **Preventive Cleaning.** In order to efficiently clean the cooling system of rust, scale, or sludge, use a cleaner followed by a neutralizer to stop the action of the cleaner. Federal stock No. 51-C-1568-500 provides cleaner and neutralizer enough to clean a cooling system of a four-gallon capacity. Neutralizing, and flushing after neutralizing, is very important as the cleaner contains a strong acid which, if not completely removed, will attack the parts of the cooling system. Also precautions should be taken not to spill any cleaning compound on the skin, clothing, or vehicle paint. **CAUTION:** *Do not pour cold water into cooling system when engine temperature is above 200° F. Also cold water poured into the cooling system, regardless of engine temperature, will close the thermostat and not allow the engine water jackets and passages to completely fill. Whenever filling system with cold water, always run engine until normal operating temperature is reached (thermostat opens), then add water until liquid level is visible through filler neck.*

(1) **DRAIN SYSTEM.** Run engine fast idle until normal engine operating temperature is reached (at least 165° F) to stir up any loose rust, scale, etc. Remove radiator filler cap, open radiator and cylinder block drain cocks, and allow cooling system to drain.

(2) **CLEAN SYSTEM.** Close radiator and cylinder block drain cocks. Disconnect overflow tank (if vehicle has one) and place a clean container under overflow tube to catch any overflow, which may be needed to maintain proper liquid level in the radiator. Be

COOLING SYSTEM

sure temperature of engine is below 200° F. Pour cleaning compound (one container to every four gallons of cooling system capacity) into radiator, then fill system with water. Install pressure type cap on radiator. If vehicle is equipped with an overflow tank, move pressure type cap from overflow tank to radiator. Start engine and run it at fast idle to heat solution to at least 180° F. Use a cardboard to cover radiator if necessary, but do not allow to boil. Con-

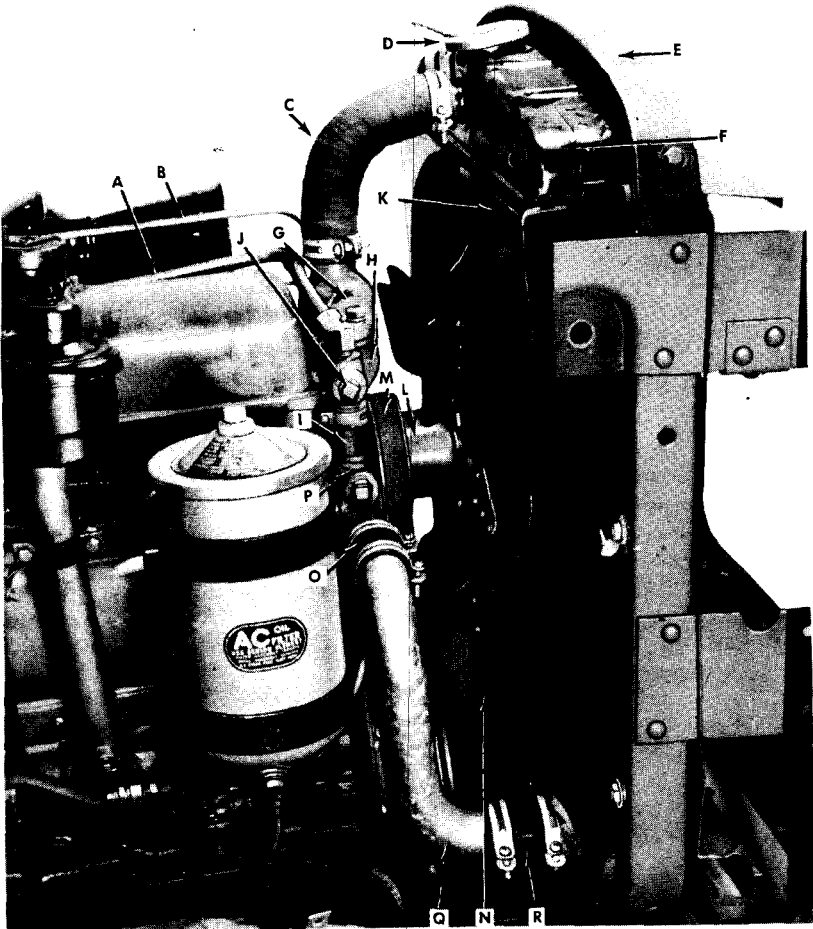

- A CYLINDER HEAD WATER BY-PASS TUBE
- B FUEL PUMP TO CARBURETER FUEL LINE
- C RADIATOR INLET HOSE
- D RADIATOR FILLER CAP
- E RADIATOR UPPER SUPPORT
- F RADIATOR
- G CYLINDER HEAD WATER OUTLET
- H THERMOSTAT HOUSING
- I BY-PASS TEE TO ELBOW HOSE

- J BY-PASS TEE
- K FAN SHROUD
- L WATER PUMP PULLEY
- M GENERATOR AND WATER PUMP DRIVE BELT
- N FAN BLADES
- O OUTLET PIPE HOSE
- P WATER PUMP BY-PASS INLET ELBOW
- Q RADIATOR OUTLET PIPE
- R OUTLET PIPE HOSE

Figure 98—Cooling System Units

RA PD 332978

TRUCK, 2 1/2-TON, 6 x 6

tinue to run engine at least 30 minutes. Stop engine, remove radiator cap, open radiator and cylinder block drain cocks, and allow system to drain completely.

(3) **NEUTRALIZE SYSTEM.** Close radiator and cylinder block drain cocks. Pour neutralizer (one container to every four gallons of cooling system capacity) into radiator, then fill system with water and install radiator cap. Start engine and run it at a fast idle, using radiator cover as necessary, to heat solution to at least 180° F. Continue to run engine at least 10 minutes. Remove radiator cap, open radiator and cylinder block drain cocks, and allow system to drain completely.

(4) **FLUSH SYSTEM.** Close radiator and cylinder block drain cocks. Fill system with clean fresh water (soft if possible), then install radiator cap. Start engine and run it at a fast idle, using radiator cover as necessary, to bring engine operating temperature to at least 180° F. Continue to run engine for at least 5 minutes. Remove radiator cap, open radiator and cylinder block drain cocks, and allow system to drain. If water drained is discolored to any extent, repeat this flushing operation. **CAUTION:** *Do not flush system by inserting a hose in the radiator, with the engine running and the drain cocks open. This procedure will close the thermostat and stop circulation of the water through the engine.*

(5) **CLEAN RADIATOR, CAP, OVERFLOW TUBE, TANK, AND DRAIN TUBES.** Clean cap by spraying a stream of water (hot if possible) through the holes in the valve cage while moving the pressure valve up and down with a blunt wooden instrument or a pencil. Clean out overflow pipe with a stream of water and rinse out overflow tank (if vehicle is so equipped), then connect overflow tank. Clean out dirt, trash, and insects imbedded in the air passages of the radiator, using compressed air or a stream of water; but do not use steam. **CAUTION:** *Do not hold air or water hose too close to the radiator or use too great pressure as damage to radiator may result. Clean out any stoppage in drain hose with a soft wire or straw.*

(6) **FILL SYSTEM.** Close radiator and cylinder block drain cocks; then fill system to suit climatic conditions as follows: If above 32° F, almost fill the system with clean fresh water (soft if possible), add a corrosion inhibitor, then fill with water until liquid level is visible through filler neck. If there is a possibility that climate below 32° F will be encountered, fill system about one-quarter full, add anti-freeze enough for the lowest expected temperature (par. 31), then fill until liquid level is visible through filler neck. Install radiator cap, start engine and run it at a fast idle until temperature gage shows normal operating temperature (par. 18 d); then stop engine and check coolant level, adding water as necessary.

b. Air Suction and Exhaust Gas Leakage. Air circulating through the cooling system, as well as exhaust gas leaking into the system, causes rapid corrosion and rust formation which will eventually clog the system and cause overheating and loss of cooling liquid. The air may be drawn into the system due to low liquid level in the radiator, leaky water pump, or loose fitting connections. Ex-

COOLING SYSTEM

haust gas may be blown into the cooling system past the cylinder head gasket or through cracks in the cylinder head and block.

(1) **AIR SUCTION TEST.** Adjust level of cooling liquid in radiator, allowing room for expansion so as to avoid any overflow loss during test. Replace radiator cap with a plain type cap. Be sure cap gasket [(GM-846732) G103-15-93621] is in good condition and will form an airtight seal. Attach a length of rubber tube to lower end of overflow tube (this connection must be airtight). Run engine with transmission in neutral gear at a safe high speed until temperature gage stops rising and remains stationary. Without changing engine speed, put end of rubber tube in a bottle of water, avoiding kinks and sharp bends that might block flow of air. Watch for bubbles in bottle of water. The continuous appearance of bubbles indicates that air is being sucked into the cooling system. Correct condition by tightening cylinder head bolts, water pump mounting bolts, hose clamps, and fitting connections. Also examine all hose carefully and if cracked, swollen, or deteriorated in any way, replace with a new part.

(2) **EXHAUST GAS LEAKAGE TEST.** Start test with engine cold. Remove drive belt to prevent pump operation. Drain cooling system until cooling liquid level is at top of thermostat housing, *but no lower*. This can be determined by loosening up cylinder head outlet from thermostat housing to check level of liquid. If liquid leaks from this connection, continue to drain system until liquid no longer leaks. Remove thermostat (par. 110 b). Make sure thermostat housing is full of liquid (add if necessary), then with transmission in neutral gear, start engine and accelerate it several times. Watch for bubbles in water in thermostat housing while accelerating engine, also when engine speed drops back to normal. The appearance of bubbles or a sudden rise of cooling liquid indicates exhaust gas leakage into cooling system. Make test quickly before boiling starts as steam bubbles will give misleading results. If exhaust gas leakage is evident, replace cylinder head gasket, then test again. If leaks are still evident, it indicates cylinder head or block is cracked. Report to higher authority. Install thermostat (par. 110 c), install and adjust drive belt (par. 108), then fill radiator.

c. **Rust Preventives.** The cooling system must be free of rust and scale to maintain efficiency of the system. Use of inhibitors or rust preventives reduces or prevents corrosion of metals and prevents formation of scale. Inhibitors are not cleaners and do not remove rust or scale already formed. Treating the cooling system with an inhibitor consists of adding an inhibitor to the cooling liquid. The inhibitor should be renewed periodically and especially if the system has been cleaned or flushed.

108. FAN AND BELT.

a. **Description.** A five-bladed fan, mounted on the water pump drive pulley hub, is driven by a "V" type belt from the crankshaft pulley in conjunction with the water pump and generator.

b. **Fan Removal.** Remove four cap screws (fan to water pump) and remove fan blades.

TRUCK, 2 1/2-TON, 6 x 6

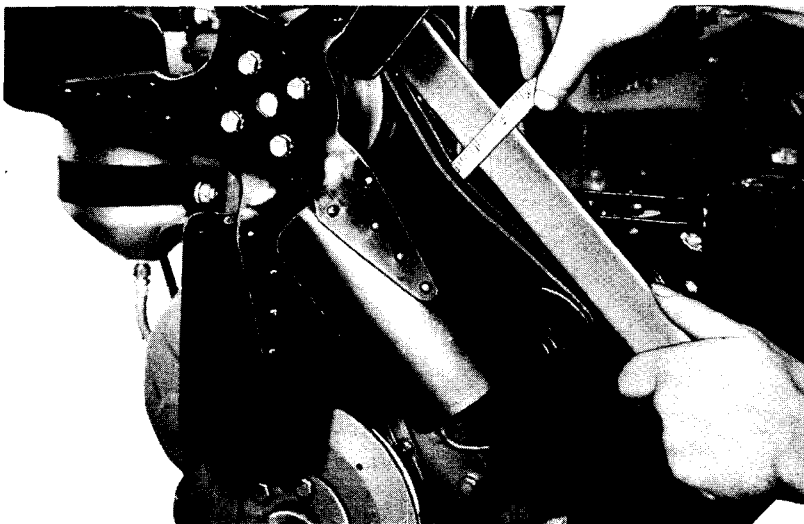

RA PD 332910

Figure 99—Drive Belt Adjustment

c. **Fan Installation.** Position fan blades on water pump hub with straight edge of blades toward radiator—curved edges toward engine. This will position fan so notches in blades will provide clearance with crankshaft balancer. Install four cap screws (fan to water pump) and lock washers and tighten firmly.

d. **Belt Adjustment.** Loosen two generator to mounting bracket bolt nuts or through bolt nut, as case may be, then loosen generator to adjusting arm cap screw. Move generator toward or away from engine, as necessary, to obtain correct belt tension. A light pressure on belt at a point midway between generator and water pump pulleys must cause a 1/2-inch deflection (fig. 99). Tighten generator to adjusting arm cap screw, then tighten two generator to mounting bracket bolt nuts or through bolt nut, as case may be.

e. **Belt Removal.** Loosen two generator to mounting bracket bolt nuts or through bolt nut, as case may be, then loosen generator to adjusting arm cap screw. Move generator toward engine as far as it will go, then remove belt from generator, water pump, and crankshaft pulleys and remove belt [(GM-2090464) G508-01-18253] over fan blades.

f. **Belt Installation.** Thread belt over fan blades, then place belt over water pump, crankshaft, and generator pulleys. Adjust belt and tighten generator (subpar. d above).

109. RADIATOR ASSEMBLY.

a. **Description.** The radiator assembly consists of a fin and tube type core with upper and lower tanks. The radiator is mounted in a

COOLING SYSTEM

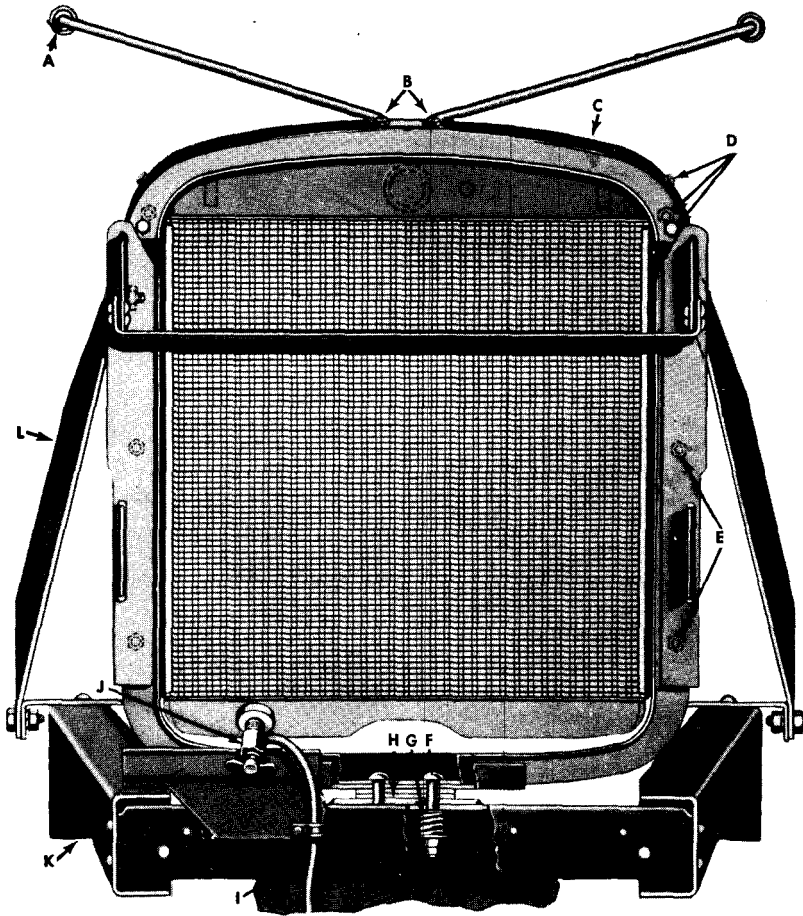

- | | |
|---|-----------------------|
| A TIE ROD ADJUSTING NUT | G SUPPORT BOLT SPRING |
| B TIE ROD TO UPPER SUPPORT CAP SCREWS | H RADIATOR CUSHION |
| C RADIATOR SUPPORT | I DRAIN COCK TUBE |
| D RADIATOR UPPER SUPPORT CAP SCREWS | J DRAIN COCK |
| E FAN SHROUD AND RADIATOR TO SUPPORT CAP SCREWS | K FRAME |
| F RADIATOR LOWER SUPPORT BOLT | L RADIATOR BRACE |

RA PD 333044

Figure 100—Radiator and Mounting

vertical position at the forward end of the engine. Air drawn by the action of the fan cools the cooling liquid as it flows through the radiator. A pressure type filler cap is used on the radiator.

b. Removal (fig. 100).

(1) **DRAIN RADIATOR.** Remove radiator cap [(GM-850033) G85-31-03620], open radiator drain cock, and allow cooling liquid to drain from radiator.

TRUCK, 2½-TON, 6 x 6

(2) **DISCONNECT BOND STRAPS.** Remove nut and lock washer and disconnect radio noise suppression bond strap at right- and left-hand side of radiator lower tank. Loosen clip bolt attaching drain cock tube.

(3) **REMOVE RADIATOR TIE ROD.** Remove two tie rod to radiator upper support screws and internal toothed lock washers. From inside of cab, remove two tie rod to cowl nuts and lock washers and remove tie rod.

(4) **REMOVE RADIATOR UPPER SUPPORT.** Remove three screws and lock washers at each end of radiator upper support and remove support.

(5) **DISCONNECT RADIATOR HOSE.** Loosen radiator upper and lower hose clamp at radiator and disconnect upper hose [(GM-2140818) G85-30-02830] and lower hose [(GM-2140852) G501-02-17816] from radiator.

(6) **REMOVE WIRING HARNESS FROM RADIATOR.** Spread clips and remove wiring harness from radiator upper tank.

(7) **REMOVE FAN ASSEMBLY.** Remove four cap screws and lock washers which attach fan to pulley and remove fan blade assembly.

(8) **REMOVE RADIATOR.** Remove six fan shroud and radiator to support cap screws and internal-external toothed lock washers (three each side); then remove fan shroud. Position radiator so that cut-out in radiator flanges will clear radiator brace to support bolt nuts; then carefully push upper portion of radiator toward engine and lift radiator out of vehicle. Unscrew drain cock from radiator for installation on replacement unit.

c. Installation (fig. 100).

(1) **INSTALL RADIATOR.** Install radiator drain cock in radiator, then lower radiator into position in vehicle. Install radiator upper support, securing it with three cap screws and lock washers at each end. Place fan shroud in position against radiator and install three cap screws and internal-external toothed lock washers at each side of radiator to attach shroud and radiator to support.

(2) **INSTALL FAN ASSEMBLY.** Position fan blades on water pump hub with straight edge of blades toward radiator—curved edges toward engine. This will position fan so notches in blades will provide clearance with crankshaft balancer. Install four cap screws (fan to water pump) and lock washers and tighten firmly.

(3) **INSTALL RADIATOR TIE ROD.** Screw inner (forward) nuts well up on ends of tie rod. Place new internal-external toothed lock washers over ends of tie rod and install ends of tie rod through holes in cowl. Install two tie rod to support screws using new internal-external toothed lock washers over ends of tie rod and start (but do not tighten) outer (rearward) nuts.

(4) **CONNECT RADIATOR HOSE.** Install radiator upper hose over radiator inlet; lower hose over radiator outlet, and tighten hose clamps.

(5) **CONNECT BOND STRAPS.** Install radio noise suppression bond straps over bolts, located at right- and left-hand side of radiator lower tank, and install internal-external toothed lock washers and nuts.

COOLING SYSTEM

Insert drain cock tube into clip, then tighten clip bolt firmly.

(6) **INSTALL WIRING HARNESS.** Fit wiring harness into clips on radiator top tank and bend clips over wire.

(7) **FILL RADIATOR.** Close radiator drain cock, fill radiator (par. 17) and install radiator cap.

d. Adjustment (fig. 100).

(1) **LOOSEN RADIATOR.** Loosen (do not remove) two radiator lower support bolt nuts, accessible from underneath vehicle, also radiator brace bolt at each side of radiator near the top.

(2) **ADJUST RADIATOR.** Adjust tie rod nuts at cowl carefully to provide $\frac{3}{4}$ inch clearance between fan blades and bottom of radiator. Be sure all four tie rod nuts are tight at cowl. Tighten radiator brace bolt nut at each side of radiator near the top, also tighten two radiator to lower support bolt nuts until springs are compressed, then back off nuts three full turns to provide proper tension on springs, then tighten lock nuts securely.

110. THERMOSTAT.

a. **Description.** The thermostat is of the bellows type, mounted in the housing at the cylinder head water outlet. The thermostat comprises a restriction valve which is thermostatically operated, and is calibrated to open gradually as the engine temperature increases. The valve in the thermostat starts to open at approximately 160° F and is fully opened at approximately 185° F. When the temperature of the cooling liquid in the engine is below the calibration of the thermostat, the valve in the thermostat remains closed, restricting the flow of the cooling liquid through the radiator. However, a by-pass around the thermostat permits circulation of the cooling liquid through the engine water passages until normal operating temperature is reached. The thermostat then is open and permits full circulation of the cooling liquid.

b. **Removal.** Remove radiator cap, open radiator drain cock and allow cooling liquid to drain from radiator. Loosen two radiator inlet

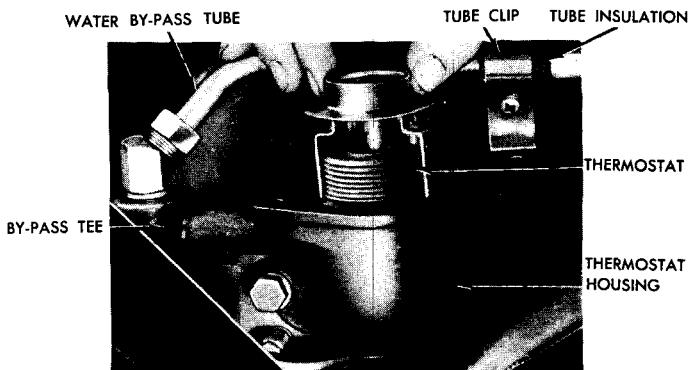
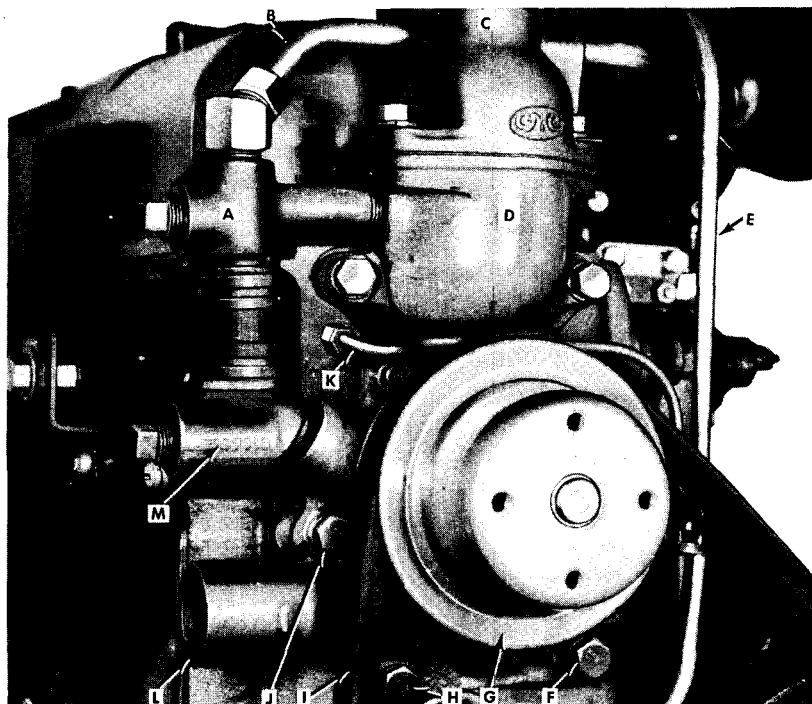

Figure 101—Thermostat Removal

RA PD 332945

TRUCK, 2½-TON, 6 x 6



- | | |
|-------------------------------------|----------------------------------|
| A BY-PASS TEE | H WATER PUMP MOUNTING BOLT |
| B CYLINDER HEAD WATER BY-PASS TUBE | I DRIVE BELT |
| C CYLINDER HEAD WATER OUTLET | J WATER PUMP MOUNTING BOLT |
| D THERMOSTAT HOUSING | K OIL TUBE |
| E FUEL PUMP TO CARBURETOR FUEL LINE | L WATER PUMP |
| F WATER PUMP MOUNTING BOLT | M WATER PUMP BY-PASS INLET ELBOW |
| G WATER PUMP PULLEY | |

RA PD 332965

Figure 102—Water Pump Mounting

hose clamps and remove hose. Remove two outlet to thermostat housing cap screws, then lift outlet from thermostat housing. Raise thermostat [(GM-3108579) G122-04-02000] from housing (fig. 101).

c. **Installation.** Place thermostat in position in housing (fig. 101). Position water outlet, with a new gasket, [(GM-838341) G85-31-06300] on thermostat housing, then install two cap screws with lock washers, assembling cylinder head water by-pass tube clip to left-hand cap screw. Be sure insulation is in place in clip. Install radiator inlet hose over cylinder head water outlet and radiator inlet and tighten hose clamps firmly. Fill radiator (par. 17).

111. WATER PUMP ASSEMBLY.

a. **Description.** A centrifugal type water pump is mounted on the cylinder block at the timing gear end of the engine. The water

COOLING SYSTEM

pump is a packless type and does not require a packing gland to prevent leakage around the shaft. The impeller action of the water pump forces the cooling liquid through the engine water passages, radiator, and connections. The pump is driven, in conjunction with the generator, with a belt by the engine crankshaft.

b. Removal.

(1) **DRAIN SYSTEM AND REMOVE FAN AND DRIVE BELT.** Remove radiator cap; then open radiator and cylinder block drain cocks and allow cooling system to drain. Remove four fan to water pump cap screws and remove fan blades. Remove drive belt (par. 108).

(2) **REMOVE PUMP CONNECTIONS.** Loosen radiator outlet pipe to water pump hose clamp screw at water pump and remove hose from water pump. Loosen water by-pass elbow hose clamp screws, and loosen hose [(GM-2137582) G501-02-17816] from elbow.

(3) **REMOVE PUMP.** Remove four water pump to cylinder block cap screws (fig. 102), and remove pump [(GM-2103002) G85-11-01740] and gasket [(GM-838137) G85-11-00960] from vehicle.

(4) **REMOVE BY-PASS ELBOW.** Unscrew water by-pass elbow from water pump for installation in replacement pump.

c. Installation.

(1) **INSTALL BY-PASS ELBOW.** Screw water by-pass elbow tightly into water pump. Coat threads of elbow with anti-seize compound, mica base.

(2) **INSTALL PUMP ON ENGINE.** Place a new water pump to cylinder block gasket in position, then place water pump in position on engine, directing inlet elbow into hose. Install one 1 $\frac{7}{8}$ -inch cap screw with lock washer in water pump bolt hole just above water inlet and tighten finger-tight. Then install remaining three cap screws with lock washers (fig. 102), assembling fuel and oil lines clip and generator adjusting arm. Tighten all four cap screws evenly and firmly.

(3) **INSTALL PUMP CONNECTIONS.** Tighten water by-pass elbow hose clamp screws. Install radiator outlet pipe to water pump inlet and tighten hose clamp screws.

(4) **INSTALL FAN AND DRIVE BELT AND FILL SYSTEM.** Install and adjust belt (par. 108). Position fan blades on water pump hub with straight edge of blades toward radiator—curved edges toward engine. This will position fan so notches in blades will provide clearance with crankshaft balancer. Install four cap screws (fan to water pump) with lock washers and tighten firmly. Close radiator and cylinder block drain cocks, then fill system (par. 17).

112. HOSE AND FITTINGS.

a. **Description.** Hose connections are provided at each end of the radiator outlet pipe, at the radiator inlet, and at the water by-pass inlet elbow at the water pump. A cylinder head water by-pass tube extends from the rear of the cylinder head to the water pump.

TRUCK, 2½-TON, 6 x 6

b. Cylinder Head Water By-pass Removal.

(1) **REMOVE RADIATOR INLET HOSE.** Remove radiator cap, then open radiator and cylinder block drain cocks and allow cooling system to drain. Loosen two hose clamps, then loosen and remove hose from radiator and cylinder head connections.

(2) **REMOVE CYLINDER HEAD WATER BY-PASS TUBE.** Remove by-pass tube clip nut and screw. Unscrew flange nuts at each end of by-pass tube, then remove tube from tube clip and insulator.

(3) **REMOVE WATER BY-PASS TEE TO WATER PUMP INLET ELBOW HOSE.** Loosen hose clamps, then remove two thermostat housing to cylinder head cap screws and remove water outlet, thermostat housing, and by-pass tee as an assembly. Remove hose from water pump inlet elbow.

c. Cylinder Head Water By-pass Installation.

(1) **INSTALL WATER BY-PASS TEE TO WATER PUMP INLET ELBOW HOSE.** Place two hose clamps over hose, then install hose over water pump inlet elbow. Position gasket [(GM-838297) G85-31-06280] and water outlet, thermostat housing, and by-pass tee assembly on cylinder head, directing by-pass tee into hose; then install two housing to cylinder head cap screws with lock washers. Position hose clamps and tighten firmly.

(2) **INSTALL CYLINDER HEAD WATER BY-PASS TUBE.** Coat threads of by-pass tube flange nuts with anti-seize compound, mica base, then place insulator over tube. Position tube in clip at thermostat housing, with insulator under clip, then screw flange nuts into their respective fittings firmly. Install clip screw, lock washer, and nut.

(3) **INSTALL RADIATOR INLET HOSE.** Place hose clamps in position over hose. Install hose over cylinder head and radiator connections, then tighten hose clamps firmly. Fill cooling system (par. 17).

Section XX

STARTING SYSTEM

113. DESCRIPTION.

a. The starting system comprises a cranking motor, switch attached to cranking motor body, pedal control linkage which actuates cranking motor switch, and cable connection to vehicle battery. The cranking motor is attached to the right-hand side of the clutch housing and is equipped with an over-running clutch drive which is manually shifted into engagement with the flywheel. The cranking motor switch, mounted on cranking motor, completes the electrical circuit between the battery and the motor when the cranking motor is being used. The upper end of the shift lever engages the switch button

STARTING SYSTEM

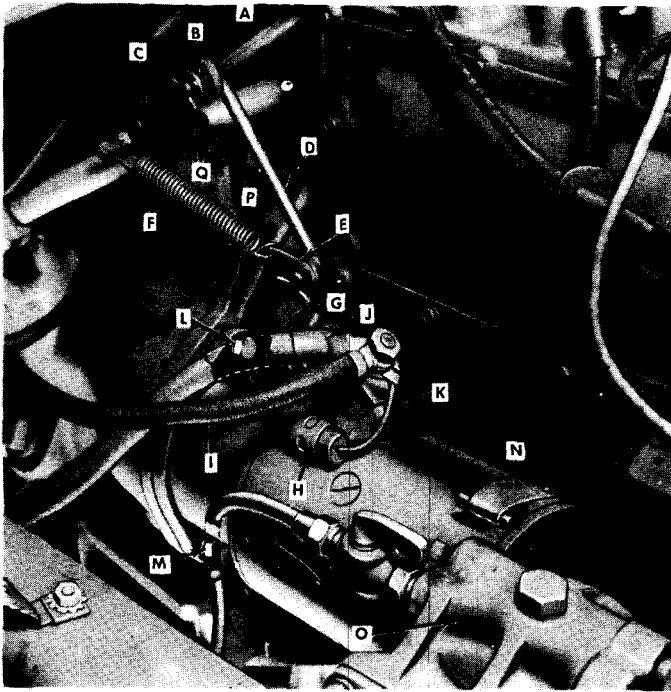

- | | |
|-------------------------------------|-------------------------|
| A PEDAL LEVER ASSEMBLY (WITH SHAFT) | J BATTERY CABLE |
| B ANTI-RATTLE SPRING | K CRANKING MOTOR SWITCH |
| C PEDAL SHAFT BRACKET | L STUD NUT |
| D LEVER TO CRANKING MOTOR LINK | M CAP SCREW |
| E PULL BACK SPRING CLIP | N BAND |
| F PULL BACK SPRING | O FUEL FILTER |
| G CRANKING MOTOR LEVER | P PEDAL SHIFT BRACKET |
| H CONDENSER | Q BRACKET CAP SCREWS |
| I CRANKING MOTOR TO AMMETER CABLE | |

RA PD 333045

Figure 103—Cranking Motor Installed

after the pinion has fully engaged the flywheel gear, or when the spring is sufficiently compressed to force the pinion into mesh as soon as the armature rotates. When the engine has started, the action of the over-running clutch allows the pinion to rotate at flywheel speed; therefore the armature is not speeded up to a dangerous speed.

114. CRANKING MOTOR.

a. **Cleaning Commutator.** Remove cover band and inspect commutator for dirty condition, roughness, burned spots, and high mica. If commutator is dirty, it can sometimes be cleaned with a strip of 2/0 flint paper. Never use emery cloth to clean commutator. All dust must be blown from cranking motor after commutator has been cleaned. If commutator is rough, burned, or has high mica, cranking motor should be replaced.

TRUCK, 2½-TON, 6 x 6

b. Switch Replacement (fig. 103).

(1) REMOVAL.

(a) Disconnect Cables. Remove ground strap from battery. Remove cranking motor switch terminal nut, two cables, and condenser wire.

(b) Remove Switch and Condenser. Remove two screws and lock washers attaching switch to cranking motor housing. Remove condenser and cranking motor switch [(GM-820052) G85-33-03560].

(2) INSTALLATION.

(a) Install Switch and Condenser. Use two screws and lock washers to attach switch and condenser to cranking motor housing. Tighten screws securely.

(b) Connect Cables. Install cranking motor to ammeter cable, cranking motor to battery cable (GM-5275716), and condenser pig-tail wire over cranking motor switch terminal. Replace lock washer and nut. Tighten nut securely. Reinstall ground strap to battery.

c. Cranking Motor Replacement (fig. 103).

(1) REMOVAL. Remove ground strap from battery.

(a) Remove Fuel Filter. Refer to paragraph 98 c.

(b) Remove Cables. At cranking motor, remove cranking motor to battery cable, cranking motor to ammeter cable, and condenser wire.

(c) Disconnect Linkage. Remove pedal pull back spring. Remove cotter pin which retains lever link to cranking motor lever. Withdraw link and pull back spring clip from lever.

(d) Remove Cranking Motor. Remove stud nut and lock washer at top, also bolt and lock washer at bottom which attach cranking motor to clutch housing. Pull cranking motor [(GM-1107418) G85-11-01540] straight away from housing to remove.

(2) INSTALLATION.

(a) Position Cranking Motor. Locate cranking motor in its correct position with switch at top. Install stud nut at top, and bolt at bottom, using internal toothed lock washer under nut and bolt. Tighten nut and bolt alternately until cranking motor is seated firmly in place.

(b) Install Fuel Filter. Refer to paragraph 98 d.

(c) Connect Linkage. Insert lever link into shift lever, then place spring clip over end of link. Insert and bend cotter pin. Install pedal pull back spring.

(d) Connect Cables. Clean switch terminal post and cable terminals thoroughly. Install condenser wire, battery to cranking motor cable, and cranking motor to ammeter cable to switch terminal post. Install lock washer and nut on terminal, and tighten firmly. Install ground strap to battery, then test action of cranking motor.

115. CRANKING MOTOR CONTROLS.

a. Control linkage comprises a lever and shaft assembly bolted with brackets to clutch housing, with a link connecting the cranking motor shift lever and bracket lever.

STARTING SYSTEM

b. Removal (fig. 103).

(1) **REMOVE TOE BOARD.** Remove cranking motor pedal button. Remove toe board. Brackets and shaft are then accessible.

(2) **DISCONNECT LINKAGE.** Disconnect linkage and spring [(GM-598073) G85-33-03250] at cranking motor lever.

(3) **REMOVE LEVER AND SHAFT ASSEMBLY.** Remove two cap screws which attach brackets on each side of clutch housing. A spacer is used under each bracket. Lever and shaft assembly may then be lifted from clutch housing.

c. Installation (fig. 103).

(1) **INSTALL LEVER AND SHAFT ASSEMBLY.** Position lever and shaft assembly on clutch housing with brackets and spacers in place. Install and tighten cap screws.

(2) **CONNECT LINKAGE TO CRANKING MOTOR.** Connect link and spring clip to cranking motor shift lever. Install pull back spring. Anti-rattle springs are used at link connection to bracket, and at pedal shaft bracket to shaft.

(3) **INSTALL TOE BOARD.** Install toe board, then install cranking motor pedal button.

Section XXI

GENERATING SYSTEM

116. DESCRIPTION.

a. Units in generating system include generator, operated in connection with fan and water pump, and a three-unit regulator which controls output of generator. Diagram of generating circuit is shown in figure 104. Complete electrical circuit description and diagrams are covered in section XXIII.

117. GENERATOR.

a. **Description and Operation.** The generator is a two-brush type, mounted on left side of engine and driven by a belt from the crankshaft pulley in conjunction with the fan and water pump. The generator is cooled by means of air, drawn through opening in rear of unit by a fan mounted with the drive pulley. Generator mountings will permit positioning of the assembly to provide proper tension on drive belt. Adjustment of drive belt is described in paragraph 108.

b. **Cleaning Commutator.** Remove cover band and inspect commutator. If dirty, clean with a strip of 2/0 flint paper. Do not use emery cloth. Blow out all dust with compressed air and install cover band. Report to proper authority if the commutator is excessively rough.

TRUCK, 2 1/2-TON, 6 x 6

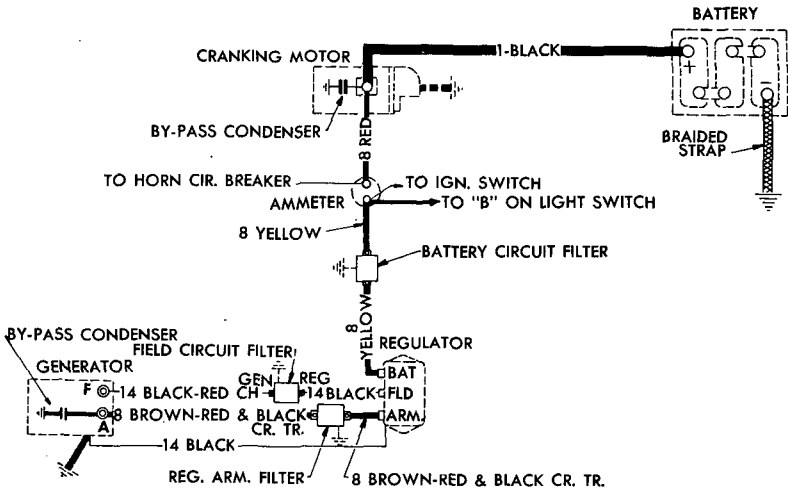

RA PD 333022

Figure 104—Generating Circuit

c. Assembly Removal.

(1) DISCONNECT WIRES. Remove ground strap at battery terminal. Remove nut, lock washer, and wire at "FLD" terminal on generator. Remove nut, lock washer, condenser pigtail, and armature wire at "ARM" terminal on generator.

(2) REMOVE CONDENSER. Remove screw and two internal-external toothed lock washers attaching condenser and ground wire ("GRD") to generator housing and lay condenser aside.

(3) LOOSEN DRIVE BELT. Remove cap screw, lock washer, and flat washer attaching generator to adjusting arm.

(4) REMOVE GENERATOR. Remove two nuts, lock washers, and bolts attaching generator to mounting bracket. On late vehicles, remove long through-bolt attaching generator to mounting bracket. Remove belt [(GM-2090464) G508-01-18253] from generator pulley and lift generator [(GM-1105864) G501-01-93910] out.

d. Assembly Installation.

(1) INSTALL GENERATOR. Lower generator into place and install two bolts (one at each end) attaching generator to mounting bracket. Install nuts and lock washers on bolts and draw up fingertight. On late vehicles, install one through-bolt instead of two bracket bolts.

(2) INSTALL DRIVE BELT. Place belt in recess in fan pulley, crankshaft pulley, and generator pulley. Attach generator to adjusting arm using flat washer, lock washer, and cap screw. Adjust belt tension (par. 108), then tighten nuts on mounting bolts.

(3) INSTALL CONDENSER. Install condenser and ground wire (No. 14 black) on generator housing, using screw and two internal-

GENERATING SYSTEM

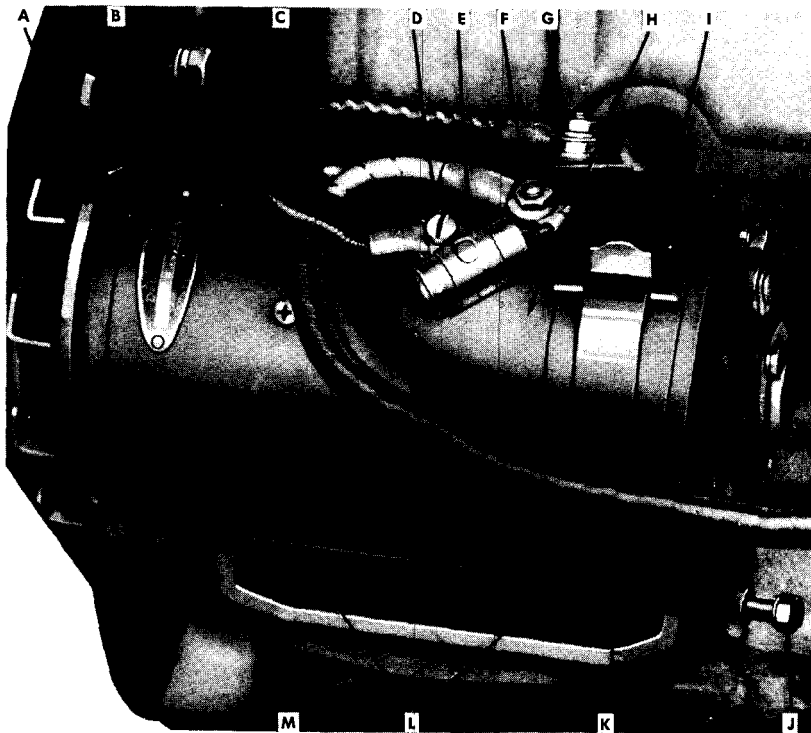

- | | |
|---------------------------|----------------------------|
| A DRIVE BELT | H GENERATOR |
| B ADJUSTING CAM | I COVER BAND |
| C ADJUSTING ARM CAP SCREW | J THROUGH BOLT (LATE TYPE) |
| D GROUND TERMINAL | K WIRING HARNESS |
| E CONDENSER | L MOUNTING CAP SCREWS |
| F ARM TERMINAL | M MOUNTING BRACKET |
| G FLD TERMINAL | |

RA PD 333021

Figure 105—Generator Installed

external toothed lock washers. Be sure *two* internal-external toothed lock washers are used, one next to generator housing and one under head of screw.

(4) **CONNECT WIRES.** Attach condenser pigtail and armature wire (No. 8 tan-red and black cross tracer) to "ARM" terminal on generator with nut and lock washer. Attach field wire (No. 14 black-red check) to "FLD" terminal on generator with nut and lock washers. Tighten nuts securely. Install ground strap at battery.

e. **Polarizing Generator.** When generator or regulator wires have been disconnected, especially when new unit is being installed, generator must be polarized after units are installed, *before engine is started*. Failure to polarize generator will cause regulator points to vibrate excessively and burn. Remove wire (No. 14 black-red check) from "FLD" terminal at generator. Use jumper wire to

TRUCK, 2½-TON, 6 x 6

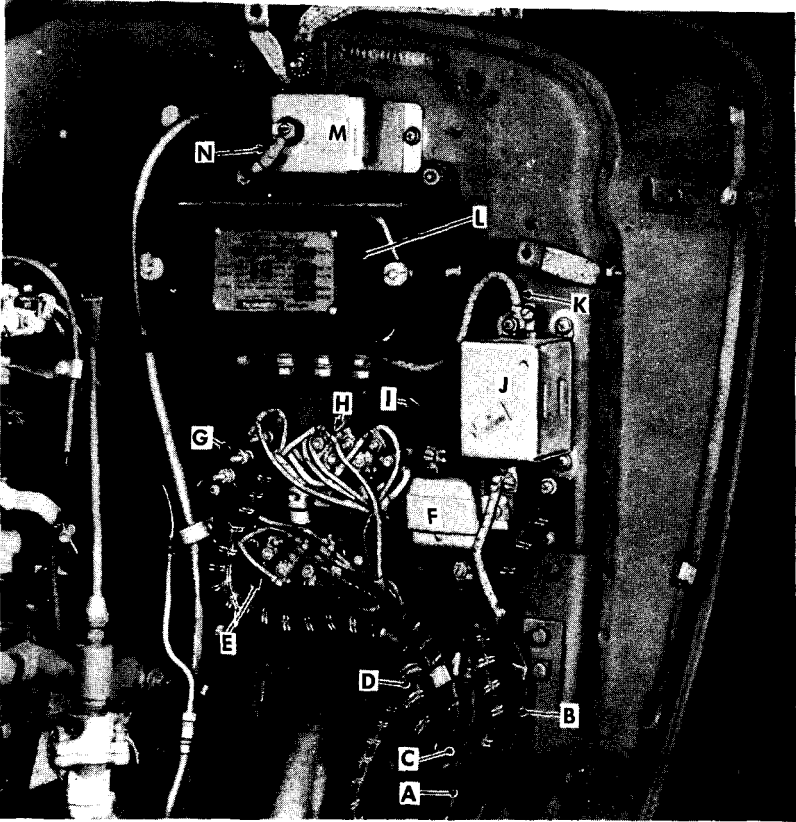

- | | |
|---|-------------------------------------|
| A FRONT END WIRING HARNESS | I FIELD FILTER TO REGULATOR WIRE |
| B GENERATOR TO REGULATOR WIRING HARNESS | J ARMATURE CIRCUIT FILTER |
| C CHASSIS WIRING HARNESS | K ARMATURE FILTER TO REGULATOR WIRE |
| D CAB WIRING HARNESS | L REGULATOR |
| E JUNCTION BLOCK—LOWER | M BATTERY CIRCUIT FILTER |
| F FIELD CIRCUIT FILTER | N BATTERY FILTER TO REGULATOR WIRE |
| G JUNCTION BLOCK—3 POST | |
| H JUNCTION BLOCK—UPPER | |

Figure 106—Regulator Installed

RA PD 64766

momentarily connect “FLD” terminal on generator and “BATTERY” terminal on regulator. This allows a momentary surge of battery current to reach generator field, which automatically gives generator the correct polarity with respect to battery it is to charge. Attach wire to generator “FLD” terminal (subpar. d (4) above).

GENERATING SYSTEM

118. REGULATOR.

a. Description. The generator regulator is a three-unit type, mounted on the cowl front panel above and to the left of the engine. The regulator unit contains a cut-out relay which automatically opens and closes the circuit between generator and battery as needs require; voltage regulator which controls generator voltage; and a current regulator which controls generator amperage output.

b. Regulator Removal (fig. 106).

(1) **DISCONNECT WIRES.** Remove ground strap from battery negative terminal. Remove nuts and lock washers from "ARMATURE," "FIELD," and "BATTERY" terminals on regulator and remove wires. Remove screw and lock washer attaching ground wire to regulator.

(2) **REMOVE REGULATOR.** Remove four nuts and lock washers from bolts attaching regulator to cowl front panel and remove regulator [(GM-1118468) G85-33-02550]. Notice that internal-external toothed lock washers are used between regulator legs and cowl.

c. Regulator Installation (fig. 106).

(1) **INSTALL REGULATOR.** Install regulator on cowl front panel with terminals down and attach with four bolts, nuts, and lock washers. Be sure internal-external toothed lock washers are installed between regulator legs and cowl. Tighten nuts securely.

(2) **CONNECT WIRES.** Install wires on terminals as follows and attach with nuts and lock washers:

"BATTERY" terminal—No. 8—yellow

"ARMATURE" terminal—No. 8—tan-red and black cross tracer

"FIELD" terminal—No. 14—black

"GROUND" terminal—No. 14—black

(3) **POLARIZE GENERATOR.** Correct polarization as described in paragraph 117 e.

d. Regulator Cover. Voltage regulators may become inoperative in service due to dust and moisture collecting inside regulator cover. A check of this condition discloses that improper sealing of gasket between regulator cover and base is a major contributing factor. Improper tightening of knurled nut on stud, to fasten cover tight against gasket and base, may permit dust and moisture to enter around gasket. Nut will not tighten properly against cover if stud threads are heavily plated or stud shoulder is too high. To check for and correct a leakage condition, proceed as follows:

(1) Press firmly on each end of assembled regulator cover after tightening knurled nut securely. If cover can be moved at all, it is evident that nut is bottomed without compressing cover gasket.

(2) Remove knurled nut and check stud threads for heavy plating or other accumulated material which might prevent proper tightening. Clean threads if necessary, using a 1/4-28 threading die.

(3) Check to see if knurled nut bottoms on stud shoulder. If this condition is found, remove stud and grind or machine shoulder. This will allow nut to fit down over stud shoulder.

TRUCK, 2 1/2-TON, 6 x 6

(4) Install stud. Check condition of cover gasket and replace if damaged. Place cover in position, thread knurled nut on stud, and tighten securely by hand. Finally, press firmly on ends of cover to see if it now seats properly.

Section XXII

BATTERY AND LIGHTING SYSTEM

119. BATTERY AND CABLES.

a. **Description.** The battery is six volt type and is located at the right side of the vehicle at the right rear corner of the cab. Ground strap connects negative (-) terminal of battery to frame side rail. Battery to cranking motor cable connects at positive (+) terminal of battery and switch on cranking motor housing.

b. **Battery Tests and Charging.**

(1) **TEST SPECIFIC GRAVITY IN CELLS.** Use an accurate-reading hydrometer and check each cell of battery for specific gravity of battery solution. Fully charged battery should test between 1.260 and 1.300. If reading is below 1.225 under normal operating conditions, battery should be replaced with a fully charged battery. Refer to paragraph 31 for testing instructions in extreme cold, and paragraph 32 in extreme climatic conditions.

(2) **TEST CELL VOLTAGE.** With ignition switch "OFF," or high tension lead removed from ignition coil, operate cranking motor and quickly check each cell of battery with low reading voltmeter (17-T-5575) in manner shown in figure 107. If voltage falls below 1.7 volts at 80°F, or if there is a difference between cell reading of more than 1/10 volt, battery is at fault and should be replaced.

(3) **CHARGING.** When battery requires charging, it should be supplied with a charging rate of one ampere per positive plate per cell or 9.0 ampere rate. Charging should continue for two hours after the gravity and terminal voltage shows no further rise. Electrolyte temperature should not be permitted to rise above 110° F.

c. **Battery Removal.**

(1) **REMOVE BATTERY COVER.** Remove two stud nuts and pull cover outward to remove.

(2) **REMOVE CABLES.** Loosen negative and positive cable terminal clamp bolt nuts. Spread terminals slightly and lift from battery posts.

(3) **REMOVE BATTERY.** Use battery lifter strap at battery terminals to lift battery [(GM-1882853) G57-01-16050] from hanger. Do not tip battery during removal, as electrolyte fluid may be spilled.

BATTERY AND LIGHTING SYSTEM**d. Battery Installation.**

(1) **INSTALL BATTERY.** Select battery and test each cell (sub-par. b (1) above). Use battery lifter strap at terminals and position battery in hanger. Positive (+) terminal of battery must be toward front of vehicle on long wheelbase models or toward outside on short wheelbase.

(2) **ATTACH CABLES.** Clean clamping surface of battery posts and cable terminals. Attach cables to respective battery terminals; ground strap to negative (-) and cranking motor cable to positive (+). Tighten clamp bolt nuts. Coat terminals with grease to prevent corrosion formation.

(3) **INSTALL BATTERY COVER.** Locate cover in place over hanger studs. Install two stud nuts and tighten.

e. **Cables.** To determine if battery cables are satisfactory, tests outlined in paragraph 120 must be made.

(1) **GROUND STRAP.**

(a) **Removal.** Remove two stud nuts and pull cover outward to remove. Remove ground strap and positive cable terminals from battery terminals by loosening terminal clamp bolt nuts. Remove terminals from battery and lift battery from hanger. Remove two nuts, lock washers, bolts, and flat washers attaching ground strap to frame. Remove strap (GM-5275715—long wheelbase), or (GM-5275713—short wheelbase).

(b) **Installation.** Immerse both terminals of ground strap in solution of ammonia and water to remove all traces of corrosion. Clean bolting surface of frame side rail with wire brush or by scraping. Attach strap to frame side rail, using two bolts with flat washers on outside and lock washers and nuts at inside of frame side rail. *Be sure all bolting surfaces are clean and that nuts are tight.* Position battery in hanger. Clean terminals of battery. Position ground strap terminal on negative (-) and cranking motor cable terminal on positive (+) terminals of battery. Use new clamp bolt and nut at each terminal. Tighten clamp bolt nut. Install battery cover and secure with two stud nuts.

(2) **BATTERY TO CRANKING MOTOR CABLE.**

(a) **Removal.** Remove two stud nuts and pull cover outward to remove. Remove nut and lock washer attaching cable to cranking motor switch terminal. Loosen clamp bolt nut and remove cable terminal from battery terminal. Pull cable (GM-5275716—long wheelbase) or (GM-5275714—short wheelbase) rearward to remove.

(b) **Installation.** Immerse both cable terminals in solution of ammonia and water to remove all traces of corrosion. Thread cable through frame side rail, then through support clips and grommets, until cable is in position along inside of frame side rail. Connect cable to cranking motor switch terminal. Install lock washer and nut. Tighten nut. Position cable terminal over positive (+) battery terminal. Use new clamp bolt and nut. Tighten clamp bolt nut. Install battery cover and secure with two stud nuts.

TRUCK, 2½-TON, 6 x 6**(3) ENGINE GROUND STRAP.**

(a) *Removal.* Remove cap screw, lock washer, and flat washer attaching strap to hand brake lever bracket at right side of transmission. Remove nut, lock washer, flat washer, and bolt attaching strap to right-hand motor support. Remove strap.

(b) *Installation.* Immerse both ends of strap in solution of ammonia and water to thoroughly clean. Wire brush points at which cable attaches. Attach strap to hand brake lever bracket, using flat washer, lock washer, and cap screw. Attach opposite end of strap to engine support, using bolt, flat washer, lock washer, and nut. Tighten mountings to obtain good ground at both ends of strap.

120. LINE VOLTAGE TESTS.

a. **General.** Excessive resistance caused by poor terminal connections and partial short circuits caused by defective insulation will result in abnormal voltage drop in cranking motor cable which will cause voltage at cranking motor to be so low that normal operations of cranking motor will not be obtained. Abnormal voltage drop can be detected with a low-reading voltmeter.

b. Tests.

(1) Check voltage drop between grounded battery terminal (negative) and vehicle frame. Place one prod of test voltmeter on grounded battery terminal and other on vehicle frame (fig. 107). With ignition switch "OFF," crank engine with cranking motor. If voltmeter reading is more than 1/10 volt, there is excessive resistance in this circuit and ground strap must be cleaned or replaced (par. 119 e).

(2) Check voltage drop between ungrounded battery terminal (positive) and cranking motor switch stud. Place one prod of voltmeter on ungrounded battery terminal and other on cranking motor switch stud (fig. 107). With ignition switch "OFF," crank engine with cranking motor. If voltmeter reading is more than 1/10 volt, there is excessive resistance in this circuit and terminals must be cleaned or cable replaced (par. 119 e).

(3) Check voltage drop between cranking motor housing and vehicle frame. Place one prod of test voltmeter on cranking motor housing and other on vehicle frame (fig. 107). With ignition switch "OFF," crank engine with cranking motor. If voltmeter reading is more than 1/10 volt, there is excessive resistance in this circuit. Remove and clean or replace transmission to frame ground strap (par. 119 e) or tighten cranking motor to clutch housing mountings. Remove switch from cranking motor housing and clean contact surfaces on switch and housing (par. 114 b).

121. HEADLIGHTS.

a. **Description.** Service headlights, mounted on right- and left-hand fenders, are double filament "sealed beam" type (fig. 110). These lights can only be illuminated when main light switch is in

BATTERY AND LIGHTING SYSTEM

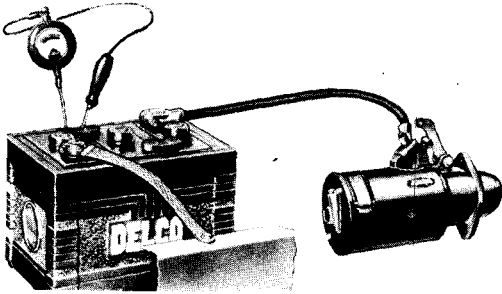

BATTERY CELL VOLTAGE TEST

**VOLTAGE DROP TEST BETWEEN BATTERY
GROUND TERMINAL AND FRAME**

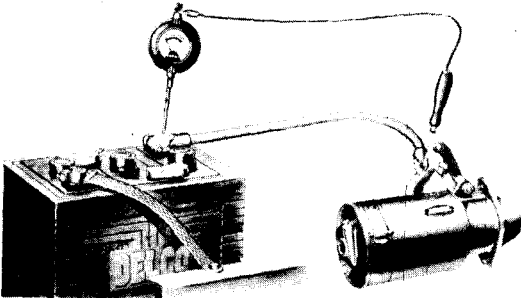
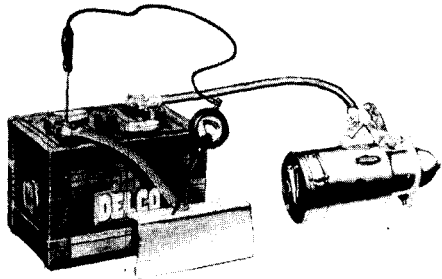

**VOLTAGE DROP TEST BETWEEN
UNGROUNDING BATTERY TERMINAL
AND CRANKING MOTOR SWITCH**

**VOLTAGE DROP TEST BETWEEN
CRANKING MOTOR AND
FRAME**

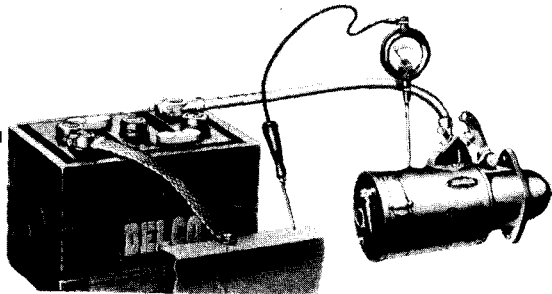

**Figure 107—Battery Cell and Line Voltage Tests, Using
Low-Reading Voltmeter (17-T-5575)**

RA PD 332984

TRUCK, 2½-TON, 6 x 6

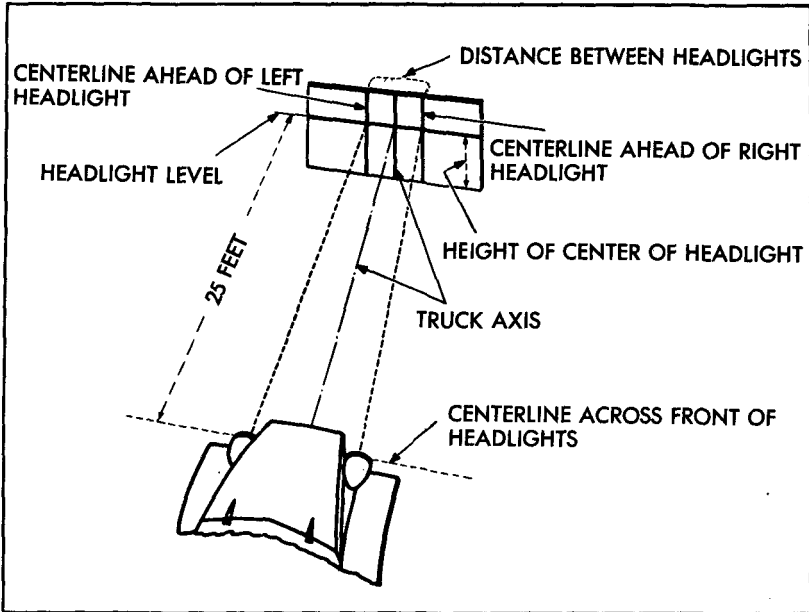

Figure 108—Headlight Adjustment Chart

RA PD 64734

operating position (par. 12 h). Upper and lower beams are selected by the foot operated dimmer switch on cab toe board.

b. Aiming Adjustment. Headlights can be adjusted quickly and accurately with a headlight tester; however, if this equipment is not available, adjustment can be made as follows:

(1) **POSITION VEHICLE** (fig. 108). Place vehicle on level floor so that headlights are 25 feet from a smooth vertical surface, such as a door or wall, preferably of a light color. The centerline of vehicle should be at right angles to the vertical surface.

(2) **LOCATE HORIZONTAL AND VERTICAL LINES** (fig. 109). Measure height of headlight center from floor, then draw a horizontal line on vertical surface at this height. Locate point on this line at which projected centerline of vehicle intersects. Measure distance between headlight centers and divide this distance equally on both sides of center mark. Draw a vertical line through each of these points. The points at which these two vertical lines intersect the horizontal line represent the centers of the right and left headlights.

(3) **TURN ON HEADLIGHTS.** Turn on headlights at main light switch on instrument panel and select high beam with dimmer switch.

(4) **ADJUST HEADLIGHTS** (fig. 109). Cover one headlight while adjusting the other. Loosen nut attaching headlight to bracket on fender. Aim headlight so that beam pattern registers with horizontal and vertical lines in manner shown in figure 109, and tighten nut

BATTERY AND LIGHTING SYSTEM

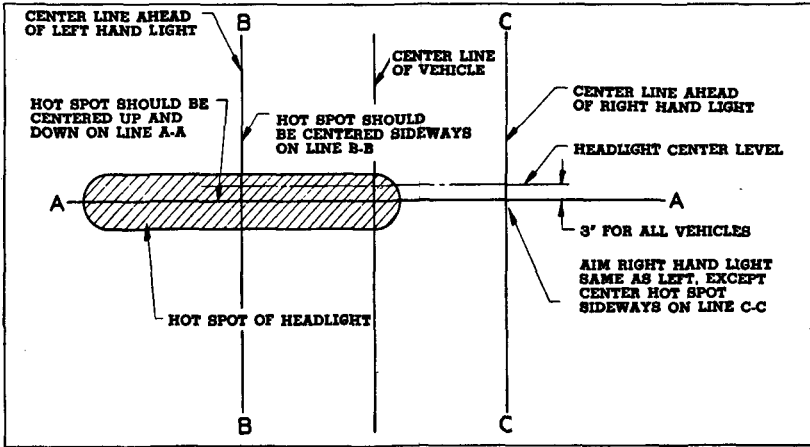

RA PD 56098

Figure 109—Headlight Aiming Pattern

securely, taking care not to change location of light beam pattern on vertical surface. Cover this light and adjust opposite headlight in the same manner.

c. **Sealed Beam Lamp-Unit Removal** (fig. 110). The complete sealed beam unit must be replaced whenever the headlight lamp burns out. The sealed beam unit comprises a lens, reflector, and lamp element sealed as a unit. Unit can be removed with assembly mounted on vehicle.

(1) **REMOVE MOULDING.** Remove moulding clamp screw at bottom of headlight lens and remove moulding ring.

(2) **REMOVE RETAINING RING.** Remove three screws attaching sealed beam unit retaining ring to headlight body and remove retaining ring.

(3) **REMOVE SEALED BEAM UNIT.** Pull sealed beam unit [(GM-925000) G85-01-01970] out of headlight body and pull wiring plug off prongs at rear of sealed beam unit.

d. **Sealed Beam Lamp-Unit Installation** (fig. 110).

(1) **INSTALL SEALED BEAM UNIT.** Press wiring plug over prongs at rear of sealed beam unit and place sealed beam unit in headlight body.

(2) **INSTALL RETAINING RING.** Installed sealed beam unit retaining ring and attach to headlight body with three screws.

(3) **INSTALL MOULDING.** Install moulding ring on headlight body with clip on ring engaged in slot at top of body. Install screw in moulding clamp at bottom of headlight lens and tighten securely.

e. **Headlight Assembly Removal** (fig. 110).

(1) **DISCONNECT WIRING.** Loosen two screws attaching headlight wires to junction block located on inside of fender skirt. Remove nut and lock washer attaching ground wire to junction

TRUCK, 2½-TON, 6 x 6

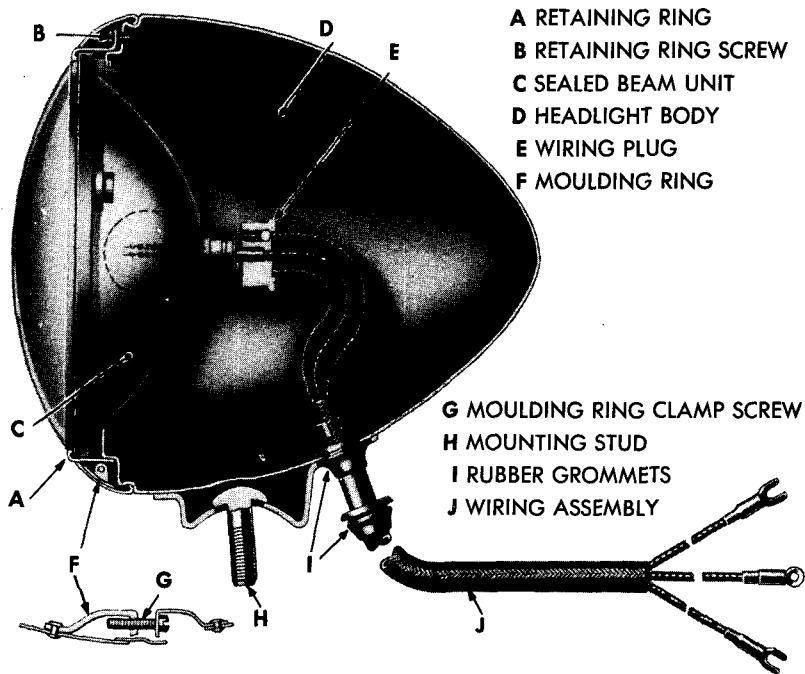

RA PD 64765

Figure 110—Headlight Assembly

block bolt, or screw and lock washer at fender skirt on late vehicles. Pull wiring out of fender skirt.

(2) REMOVE HEADLIGHT. Remove nut, lock washer, and mounting washer from bolt attaching headlight to bracket on fender. Lift headlight up and pull wiring out of fender.

f. Headlight Assembly Installation.

(1) INSTALL HEADLIGHT. Thread wiring through hole in fender and position headlight with mounting bolt through hole in headlight fender bracket. Press rubber grommet into place around wiring in fender. Install mounting washer, lock washer, and nut on mounting bolt and turn up finger-tight.

(2) CONNECT WIRING. Install wires on junction block terminals, being sure color of headlight wire matches color of harness wire (par. 128). Condenser pigtail wire must also be installed at right-hand headlight junction block. Tighten screws securely. Install ground wire connection on junction block bolt and attach with nut and lock washer. On late vehicles, position ground wire on fender skirt and attach with screw and lock washer.

(3) ADJUST HEADLIGHT. Aim headlight beam as directed in subparagraph b above.

BATTERY AND LIGHTING SYSTEM

122. BLACKOUT DRIVING LIGHT.

a. **Description.** Blackout driving light (fig. 111), mounted on the left fender to the left of the headlight, is a sealed-beam type. On some vehicles, light is controlled by a push-pull type switch on the instrument panel (marked B.O. Drive) when the main light switch is in "BLACKOUT" position. On some vehicles light is controlled by rotary-type main light switch. The blackout driving light furnishes a diffused light beam of low intensity to permit limited illumination when driving under blackout conditions.

b. **Blackout Driving Sealed Beam Lamp-Unit Removal** (fig. 111). Sealed beam unit comprises a lens, reflector, lamp element, and beam visor sealed together as a unit. This lamp-unit may be removed with assembly mounted on vehicle.

(1) **REMOVE MOULDING SCREW.** Remove door retaining screw at bottom of lens.

(2) **REMOVE SEALED BEAM LAMP-UNIT ASSEMBLY.** Pull door out at bottom and raise sealed beam lamp-unit upward to free clip at top of light body.

(3) **DISCONNECT WIRES.** Loosen screws attaching light wire to rear of sealed beam unit and ground wire to retaining ring, and remove wires.

(4) **REMOVE RETAINING RING.** Use screw driver to loosen three spring clips attaching retaining ring and sealed beam unit [(GM-5934473) M1-01-07347] in moulding.

c. **Blackout Driving Sealed Beam Lamp-Unit Installation** (fig. 111).

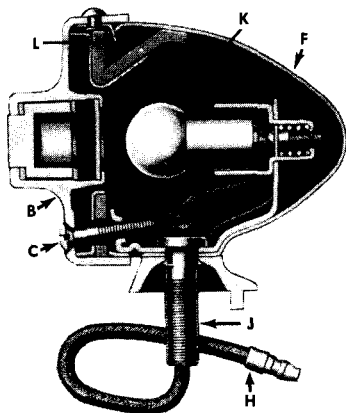

FRONT MARKER LIGHT

- A SEALED BEAM LAMP UNIT
- B DOOR ASSEMBLY
- C DOOR SCREW
- D RING ASSEMBLY
- E GROUND WIRE SCREW
- F BODY ASSEMBLY

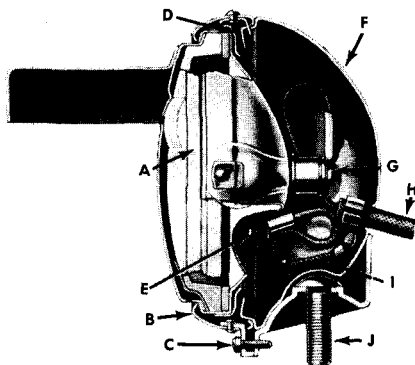

BLACKOUT DRIVING LIGHT

- G TERMINAL SCREW
- H WIRE ASSEMBLY
- I GROUND WIRE
- J MOUNTING STUD
- K LAMP
- L DOOR GASKET

Figure 111—Blackout Driving and Front Marker Lights

RA PD 332940

TRUCK, 2 1/2-TON, 6 x 6

(1) **ASSEMBLE SEALED BEAM UNIT.** Place door around front of sealed beam lamp-unit with split in moulding at bottom. Locate retaining ring with clips at back of sealed beam lamp-unit and force three retaining ring springs under flange of door.

(2) **CONNECT WIRES.** Install light wire under screw head at rear of sealed beam lamp-unit and tighten screw securely. Attach ground wire to retaining ring in the same manner.

(3) **INSTALL SEALED BEAM LAMP-UNIT.** Installed sealed beam unit assembly in light body with moulding clip engaged in slot at top of body. Install retaining screw at bottom of moulding.

d. Blackout Driving Light Assembly Removal (fig. 111).

(1) **DISCONNECT WIRE.** Loosen screw attaching blackout driving light wire to junction block located on inside of left-hand fender skirt and remove wire. Pull wire out of fender skirt and fender reinforcement.

(2) **REMOVE LIGHT.** Remove nut, lock washer, special washer, and external toothed lock washer from bolt attaching blackout driving light to bracket on fender. Lift light up, pulling wire out of fender.

e. Blackout Driving Light Assembly Installation (fig. 111).

(1) **INSTALL LIGHT.** Place light on fender with wire inserted through hole in fender and the mounting bolt through bracket. Install, in the order named, external toothed lock washer, special washer, lock washer, and nut. Draw nut up finger-tight.

(2) **CONNECT WIRE.** Thread wire through hole in fender reinforcement and through fender skirt. Connect wire to junction block with harness wire of matching color and tighten screw securely.

(3) **ADJUST LIGHT.** Hold light so the beam visor is in a horizontal position, pointing straight ahead of the vehicle, and tighten mounting nut securely.

123. BLACKOUT MARKER LIGHTS.

a. Description. Blackout marker lights (fig. 111) are mounted on the fenders at the side of each headlight, and are illuminated only when the main light switch on instrument panel is in "BLACKOUT" position. Blackout marker lights incorporate a specially designed lens and a colored filter which diffuses the light beam.

b. Door, Gasket, and Lamp Removal (fig. 111). These parts can be removed with assembly mounted on vehicle. Remove screw at bottom of marker light door. Pull door out at bottom and lift up to disengage door clip from light body. Remove door gasket from inside of body. Push lamp inward and turn to left to remove lamp from socket.

c. Door, Gasket, and Lamp Installation (fig. 111). Insert lamp in socket and turn to right. Test lamp by turning light switch on. Install door gasket in light body. Install door assembly on light body with clip on door engaging slot at top of body. Install door retaining screw at bottom of door and tighten securely.

BATTERY AND LIGHTING SYSTEM

d. Blackout Marker Lights Removal.

(1) **DISCONNECT WIRE.** Disconnect blackout marker light wire from harness by pulling plug on wire out of socket on harness. Pull wire out of clip on inside of fender skirt, withdraw from hole in fender skirt, and remove from clip under fender reinforcement.

(2) **REMOVE FENDER REINFORCEMENT.** Remove nut and internal-external toothed lock washer from bolts at each end of reinforcement. Remove nuts, lock washers, and flat washers from two bolts attaching fender reinforcement to fender and headlight bracket. Remove reinforcement. Rear bolt will be withdrawn with reinforcement.

(3) **REMOVE BLACKOUT MARKER LIGHT.** Pull loom off blackout marker light mounting stud and wire. Remove nut and internal-external toothed lock washer from mounting stud. Remove blackout marker light by raising it up and pulling wire out of fender.

e. Blackout Marker Lights Installation.

(1) **INSTALL BLACKOUT MARKER LIGHT.** Insert blackout marker light wire and mounting stud through fender. Make sure dowel on light base is in dowel hole in fender. Slide internal-external toothed lock washer and nut over wire and install on mounting stud. Tighten nut securely. Insert wire through loom and force loom over mounting stud up to the nut.

(2) **INSTALL FENDER REINFORCEMENT.** Insert wire and loom through hole in fender reinforcement and position reinforcement against fender with bolt through rear end of reinforcement inserted through fender, skirt, and hood side panel bracket. Install nuts, lock washers, and flat washers on two bolts attaching reinforcement to fender and headlight bracket, being sure wire clip is in place under flat washer on rearward bolt. Draw nuts up finger-tight. Install and tighten bolts, internal-external toothed lock washers, and nuts at each end of reinforcement. Tighten the two nuts on bolts at headlight bracket.

(3) **CONNECT WIRE.** Install wire and loom in clip under reinforcement and insert wire through fender skirt. Be sure grommet is in place in fender skirt. Insert plug on wire into socket on harness and install wire and loom in clip on inside of fender skirt.

124. STOP AND TAILLIGHTS.

a. **Description.** The stop and taillights, mounted at the rear corners of the vehicle, consists of two units. The left-hand light incorporates a combination stop and tail lamp-unit in the upper portion, and a blackout taillight lamp-unit in the lower portion (fig. 112). The right-hand light incorporates a blackout stop lamp-unit in the upper portion, and a blackout tail lamp-unit in the lower portion (fig. 112). The beams of stop and taillights are diffused so that they are not visible from above.

b. **Lamp-Unit Removal** (fig. 112). Remove two screws attaching door to light body and remove door. Remove each lamp-unit [B.O. stop—(GM-5933121) M1-01-07408; B.O. tail—(GM-5933078)

TRUCK, 2½-TON, 6 x 6

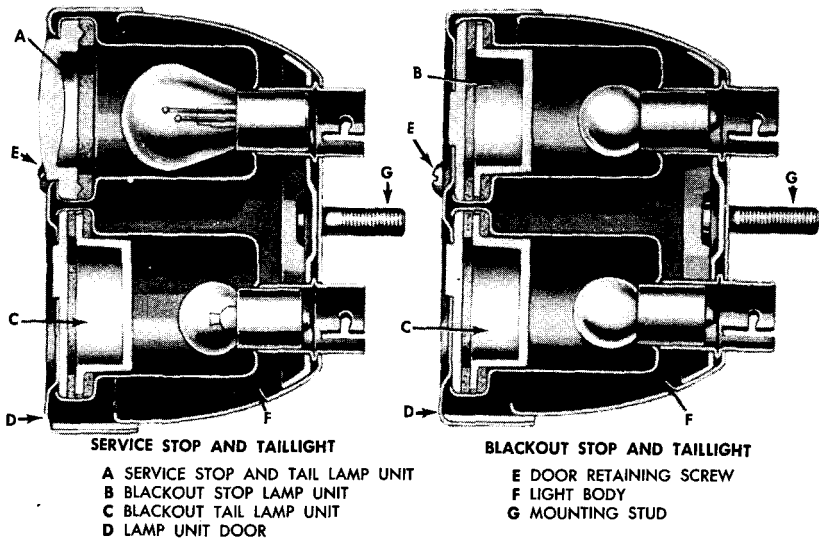

RA PD 333023

Figure 112—Stop and Taillight Assemblies

M1-01-07407; stop light—(GM-5933104) M1-01-07416] from body by pulling outward.

c. **Lamp-Unit Installation** (fig. 112). Install lamp-unit into body in its correct position. Lower units on both sides are marked "BLACKOUT TAIL SIGNAL," upper right-hand unit is marked "BLACKOUT STOP SIGNAL," while upper left-hand unit is unidentified. Position door over lamp-unit and body. Install two screws and tighten sufficiently to hold door to body.

d. **Light Removal** (fig. 112). Remove wiring connectors from sockets at rear of light by pressing inward on connector, turning to left and withdrawing from socket. Remove two nuts and external toothed lock washers from studs attaching light body to bracket and remove light assembly [left—(GM-927225) M1-01-07249; right—(GM-927226) M1-01-07248].

e. **Light Installation** (fig. 112).

(1) **INSTALL LIGHT ASSEMBLY.** Position light assembly on mounting with studs extending through holes in bracket. Attach ground wire to mounting stud. Install nuts and external toothed lock washers on studs and tighten securely.

(2) **CONNECT WIRING.** Insert wiring connectors in sockets at rear of light body, press inward and turn to left to lock in position. Wires should be connected as follows: Left-hand light — double contact plug in top socket; single contact plug in lower socket. Right-hand light — No. 16 black-red tracer in upper socket; No. 16 white in lower socket. To determine color of wire, slide connector sleeve back over loom.

BATTERY AND LIGHTING SYSTEM

125. TRAILER CONNECTOR.

a. **General.** A four-terminal connector or socket is used at rear end of most vehicles. Connector provides means of connecting stop and taillights on trailer with towing vehicle so that signal is the same at both vehicles.

b. **Removal.** Remove four nuts, lock washers, and bolts attaching connector and cover to mounting. Pull cover (also dust shield and ring on late models), rearward to remove. Remove screw, lock washer, and cover at rear of connector. Remove nut, lock washer, and wire from each of the three terminals.

c. **Installation.**

(1) **CONNECT WIRES.** Remove screw, lock washer, and cover at rear of connector. Attach three wires to following terminals; No. 12 black to "GR"; No. 16 red-black check to "SL"; No. 16 green-black check to "TL." Secure each wire to terminal with lock washer and nut. Position cover over rear of connector. Install and tighten screw with lock washer, attaching cover to connector.

(2) **INSTALL CONNECTOR.** Position connector against mounting bracket with socket slot at the bottom. On late models, position dust shield and ring against connector flanges. Install two lower bolts, lock washers, and nuts at bottom. Position cover against flange of connector (shield ring on late models), and install two bolts through cover bracket, (ring and dust shield on late models), connector, and mounting bracket. Install two lock washers and nuts. Tighten four mounting bolt nuts.

Section XXIII

WIRING, HARNESSSES, AND CIRCUITS

126. GENERAL.

a. The electrical system of these vehicles is six-volt type. Units used in various electrical systems are described in other sections of this manual as follows:

| | |
|--|--------------|
| Ignition System | Section XVI |
| Starting System | Section XX |
| Generating System | Section XXI |
| Battery and Lighting System | Section XXII |
| Radio Noise Suppression System | Section XXIV |
| Instruments, Gages, and Switches | Section XXV |

127. CIRCUITS.

a. Electrical system of this vehicle is divided into the following circuits; ignition, starting, generating, lighting, fuel gage, and horn. Circuit diagrams (figs. 113 and 114), illustrate in a schematic man-

TRUCK, 2½-TON, 6 x 6

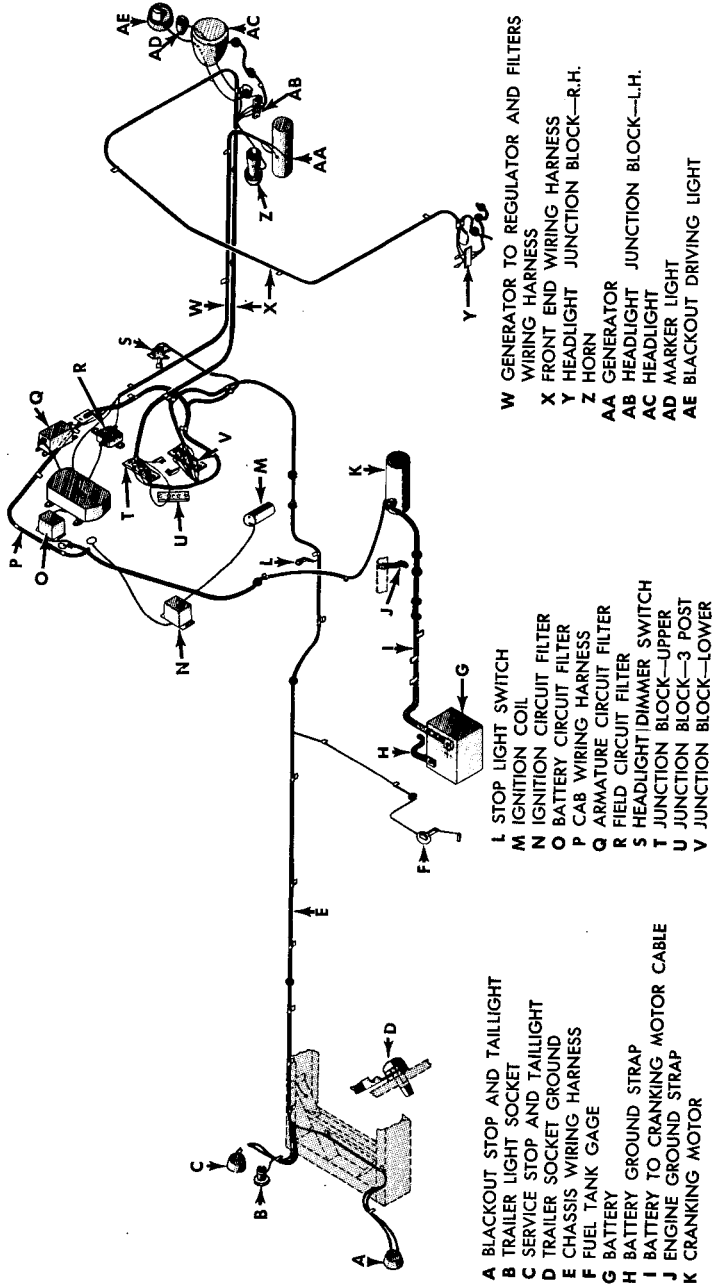

RA PD 332939

Figure 115—Arrangement of Wiring Harnesses

WIRING, HARNESES, AND CIRCUITS

ner the various electrical circuits throughout the vehicle. Each circuit can be readily traced with a conventional test light or buzzer equipment, to establish continuity of circuit.

128. WIRING AND HARNESES.

a. **Location.** General arrangement of various wiring harnesses and electrical units is illustrated in figure 115. Each harness is lo-

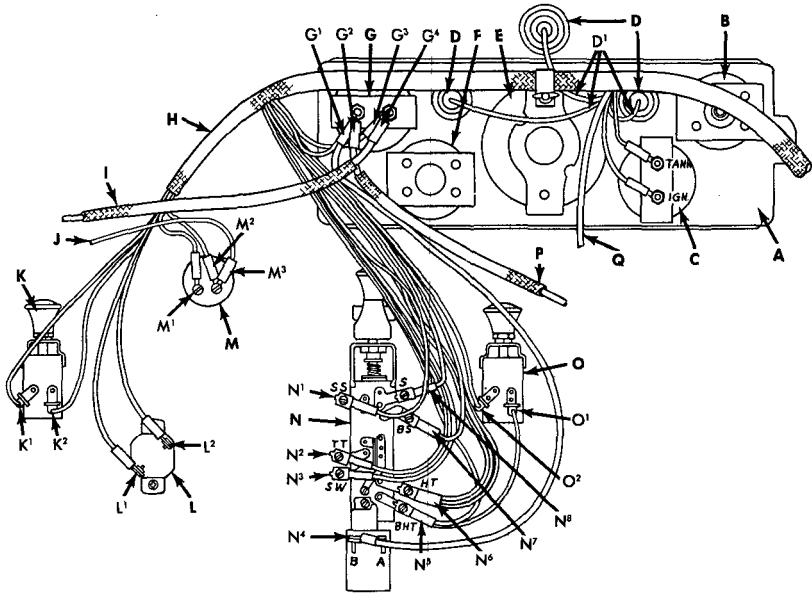

- | | |
|---|--|
| <p>A INSTRUMENT PANEL</p> <p>B WATER TEMPERATURE GAGE</p> <p>C FUEL LEVEL GAGE C¹ "IGN" NO. 16 WHITE-RED TR. C² "TANK" NO. 16 GREEN</p> <p>D INSTRUMENT PANEL LIGHTS D¹ NO. 16 GREEN BLACK CH.</p> <p>E SPEEDOMETER</p> <p>F OIL PRESSURE GAGE</p> <p>G AMMETER G¹ NO. 14 GREEN WITH NO. 10 YELLOW G² NO. 8 YELLOW (TO BATTERY FILTER) G³ NO. 16 TAN-RED AND BLACK CR. TR. G⁴ NO. 8 RED (TO CRANKING MOTOR)</p> <p>H CAB WIRING HARNESS</p> <p>I AMMETER TO CRANKING MOTOR (NO. 8 RED)</p> <p>J IGN. SWITCH TO PRIMARY IGN. FILTER (NO. 14 BLACK)</p> <p>K INSTRUMENT PANEL LIGHT SWITCH K¹ NO. 16 GREEN-BLACK CH. K² NO. 16 BLACK-GREEN TR.</p> <p>L HORN CIRCUIT BREAKER L¹ NO. 16 TAN-RED AND BLACK CR. TR. L² NO. 16 TAN-RED AND BLACK CR. TR.</p> | <p>M IGNITION SWITCH M¹ NO. 14 GREEN M² NO. 16 WHITE-RED TR. M³ NO. 14 BLACK</p> <p>N MAIN LIGHT SWITCH N¹ "SS" NO. 16 BLACK-RED CH. N² "TT" NO. 16 GREEN-BLACK CH. N³ "SW" NO. 16 RED N⁴ "B" NO. 10 YELLOW N⁵ "BHT" No. 16 WHITE-BLACK TR. WITH NO. 16 WHITE N⁶ "HT" NO. 12 BLACK-GREEN TR. WITH NO. 16 BLACK-GREEN TR. N⁷ "BS" NO. 16 BLACK-RED TR. N⁸ "S" NO. 16 RED-BLACK TR.</p> <p>O BLACKOUT DRIVING LIGHT SWITCH O¹ NO. 16 WHITE-BLACK TR. O² NO. 16 WHITE-BLACK TR.</p> <p>P AMMETER TO BATTERY FILTER WIRE (NO. 8 YELLOW)</p> <p>Q TO HORN BUTTON TERMINAL ON STEERING COLUMN (NO. 14 BLACK-WHITE TR.-LARGE)</p> |
|---|--|

Figure 116—Instrument Panel Wiring Connections (Push-Pull Main Light Switch)

RA PD 333025

TRUCK, 2½-TON, 6 x 6

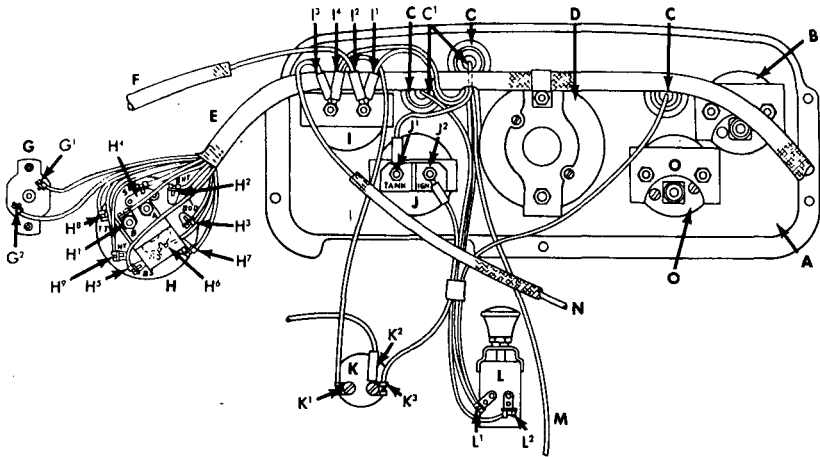

- A INSTRUMENT PANEL
- B OIL PRESSURE GAGE
- C INSTRUMENT PANEL LIGHTS
 - C¹ NO. 16 GREEN—BLACK CH.
- D SPEEDOMETER
- E CAB WIRING HARNESS
- F AMMETER TO CRANKING MOTOR (NO. 8 RED)
- G HORN CIRCUIT BREAKER
 - G¹ NO. 14 TAN—RED AND BLACK CR. TR.
 - G² NO. 14 TAN—RED AND BLACK CR. TR.
- H MAIN LIGHT SWITCH
 - H¹ "B" NO. 10 YELLOW
 - H² "BHT" NO. 16 WHITE
 - H³ "BOD" NO. 16 WHITE—BLACK TR.
 - H⁴ "SW" NO. 16 RED
 - H⁵ "BS" NO. 16 BLACK—RED TR.
 - H⁶ "SS" NO. 16 RED—BLACK CH.
 - H⁷ "S" NO. 16 RED—BLACK TR.
 - H⁸ "TT" NO. 16 GREEN—BLACK CH.
 - H⁹ "HT" NO. 12 BLACK—GREEN TR. WITH 2 NO. 16 BLACK—GREEN TR.

- I AMMETER
 - I¹ NO. 16 TAN—RED AND BLACK CR. TR.
 - I² NO. 8 RED (TO CRANKING MOTOR)
 - I³ NO. 8 YELLOW (TO BATTERY FILTER)
 - I⁴ NO. 14 GREEN WITH NO. 10 YELLOW
- J FUEL LEVEL GAGE
 - J¹ "TANK" NO. 16 GREEN
 - J² "IGN" NO. 16 WHITE—RED TR.
- K IGNITION SWITCH
 - K¹ NO. 14 GREEN
 - K² NO. 14 BLACK (TO PRIMARY CIRCUIT FILTER)
 - K³ NO. 16 WHITE—RED TR.
- L INSTRUMENT PANEL LIGHT SWITCH
 - L¹ NO. 16 GREEN—BLACK CH. (3)
 - L² NO. 16 GREEN—GREEN TR.
- M TO HORN BUTTON TERMINAL ON STEERING COLUMN WIRE (NO. 14 BLACK—WHITE TR. LARGE)
- N AMMETER TO BATTERY FILTER WIRE (NO. 8 YELLOW)
- O WATER TEMPERATURE GAGE

RA PD 333026

**Figure 117—Instrument Panel Wiring Connections
(Rotary Main Light Switch)**

cated to provide maximum accessibility for replacement or other service.

b. **Splices.** Whenever it is necessary to splice a wire, or repair one that is broken, always use solder to bond the splice. Use insulating tape profusely to cover all bare wires.

c. **Identification.** Each wire can easily be identified by its size, color, and pattern. Each wire size and color, also pattern design, is shown in figures 113 and 114. Whenever practical, a group of wires are arranged into harnesses. Wires which are included in a harness are indicated in figures 113 and 114 by showing them as passing through a loom. In several instances it has not been possible or practical to show several short wires at instrument panel within the cab wiring harness loom.

WIRING, HARNESSES, AND CIRCUITS

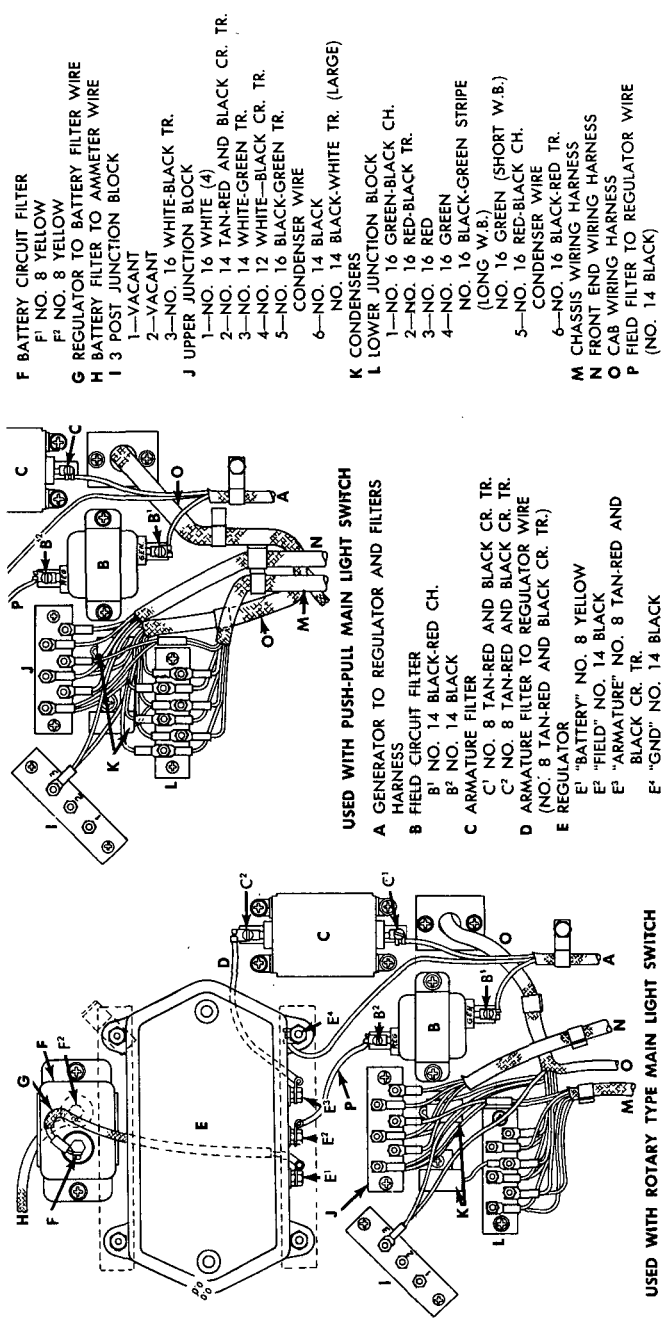

RA PD 333046

Figure 118—Wiring Harness Connections at Junction Blocks, Filters, and Regulator

TRUCK, 2 1/2-TON, 6 x 6

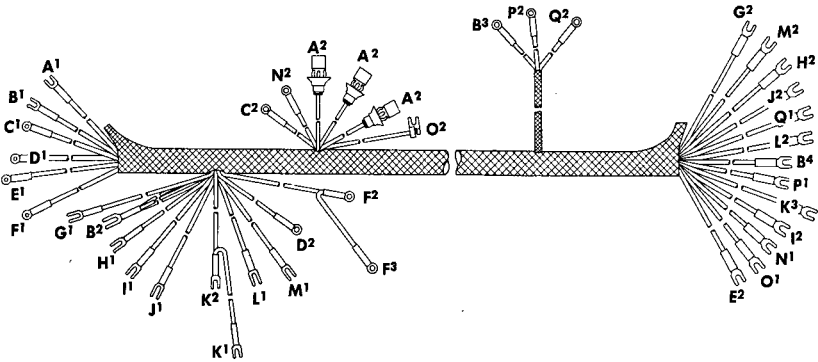

SYMBOL AND CIRCUIT

- A¹ INSTRUMENT PANEL LIGHTS
- A² INSTRUMENT PANEL LIGHTS
- B¹ INSTRUMENT PANEL LIGHTS
- B² INSTRUMENT PANEL LIGHTS
- B² DIMMER SWITCH FEED
- B² SERVICE TAILLIGHT FEED
- B³ DIMMER SWITCH FEED
- B⁴ SERVICE TAILLIGHT FEED
- C¹ FUEL GAGE FEED
- C² FUEL GAGE FEED
- D¹ HORN FEED
- D² HORN FEED
- E¹ HORN
- E² HORN
- F¹ IGNITION SWITCH FEED
- F² IGNITION SWITCH FEED
- F² LIGHT SWITCH FEED
- F³ LIGHT SWITCH FEED
- G¹ BLACKOUT DRIVING LIGHT
- G² BLACKOUT DRIVING LIGHT
- H¹ BLACKOUT STOP LIGHT
- H² BLACKOUT STOP LIGHT
- J¹ STOP LIGHT SWITCH
- J² STOP LIGHT SWITCH
- J¹ STOP LIGHT SWITCH FEED
- J² STOP LIGHT SWITCH FEED
- K¹ BLACKOUT DRIVING LIGHT
- K² BLACKOUT DRIVING LIGHT
- K³ BLACKOUT HEAD & TAILLIGHTS
- L¹ SERVICE STOP LIGHT FEED
- L² SERVICE STOP LIGHT FEED
- M¹ TRAILER TAILLIGHT
- M² TRAILER TAILLIGHT
- N¹ FUEL GAGE
- N² FUEL GAGE
- O¹ HORN
- O² HORN
- P¹ HEADLIGHTS —DIM
- P² HEADLIGHTS —DIM
- Q¹ HEADLIGHTS —BRIGHT
- Q² HEADLIGHTS —BRIGHT

WIRE SIZE AND COLOR

- NO. 16 GREEN-BLACK CH.
- NO. 16 GREEN-BLACK CH.
- NO. 16 BLACK-GREEN TR.
- NO. 16 BLACK-GREEN TR.
- NO. 12 BLACK-GREEN TR.
- NO. 16 BLACK-GREEN TR.
- NO. 12 BLACK-GREEN TR.
- NO. 16 BLACK-GREEN TR.
- NO. 16 WHITE-RED TR.
- NO. 16 WHITE-RED TR.
- NO. 14 TAN-RED & BLACK X TR.
- NO. 14 TAN-RED & BLACK X TR.
- NO. 14 TAN-RED & BLACK X TR.
- NO. 14 TAN-RED & BLACK X TR.
- NO. 14 GREEN
- NO. 14 GREEN
- NO. 10 YELLOW
- NO. 10 YELLOW
- NO. 16 WHITE-BLACK TR.
- NO. 16 WHITE-BLACK TR.
- NO. 16 BLACK-RED CH.
- NO. 16 BLACK-RED CH.
- NO. 16 RED
- NO. 16 RED
- NO. 16 BLACK-RED CH.
- NO. 16 BLACK-RED CH.
- NO. 16 WHITE-BLACK TR.
- NO. 16 WHITE-BLACK TR.
- NO. 16 WHITE
- NO. 16 WHITE
- NO. 16 RED-BLACK TR.
- NO. 16 RED-BLACK TR.
- NO. 16 GREEN-BLACK CH.
- NO. 16 GREEN-BLACK CH.
- NO. 16 GREEN
- NO. 16 GREEN
- NO. 14 BLACK-WHITE TR.
- NO. 14 BLACK-WHITE TR.
- NO. 14 WHITE-GREEN TR.
- NO. 14 WHITE-GREEN TR.
- NO. 12 WHITE-BLACK TR.
- NO. 12 WHITE-BLACK TR.

TERMINAL

- PANEL SWITCH
- LIGHT SOCKETS
- PANEL SWITCH
- LIGHT SWITCH "HT"
- LIGHT SWITCH "HT"
- LIGHT SWITCH "HT"
- "BATT"
- NO. 5 TOP JCT.
- IGNITION SWITCH
- FUEL GAGE "IGN"
- CIRCUIT BREAKER
- AMMETER
- CIRCUIT BREAKER
- NO. 2 TOP JCT.
- IGN. SWITCH
- AMMETER
- AMMETER
- LIGHT SWITCH "B"
- PANEL SWITCH
- NO. 3-3 POST JCT.
- LIGHT SWITCH "BS"
- NO. 6 BOTTOM JCT.
- LIGHT SWITCH "SW"
- NO. 3 BOTTOM JCT.
- LIGHT SWITCH "SS"
- NO. 5 BOTTOM JCT.
- PANEL SWITCH
- LIGHT SWITCH "BHT"
- LIGHT SWITCH "BHT"
- NO. 1 TOP JCT.
- LIGHT SWITCH "S"
- NO. 2 BOTTOM JCT.
- LIGHT SWITCH "TT"
- NO. 1 BOTTOM JCT.
- NO. 4 BOTTOM JCT.
- FUEL GAGE "TANK"
- NO. 6 TOP JCT.
- STEERING COLUMN
- NO. 3 TOP JCT.
- DIMMER SW. "DIM"
- NO. 4 TOP JCT.
- DIMMER SW. "BRT."

RA PD 333009

Figure 119—Cab Wiring Harness (Push-Pull Main Light Switch)

WIRING, HARNESES, AND CIRCUITS

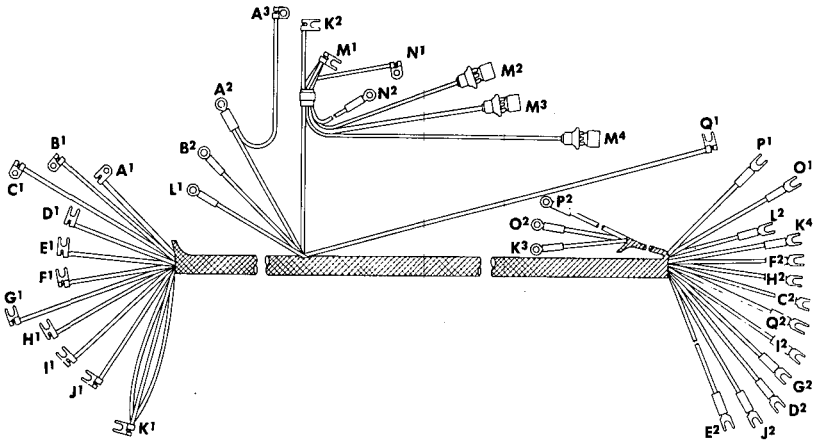

SYMBOL AND CIRCUIT

- A¹ MAIN LIGHT SWITCH FEED
- A² MAIN LIGHT SWITCH FEED
- A² IGNITION SWITCH FEED
- A³ IGNITION SWITCH FEED
- B¹ HORN CIRCUIT BREAKER FEED
- B² HORN CIRCUIT BREAKER FEED
- C¹ HORN FEED
- C² HORN FEED
- D¹ BLACKOUT LIGHTS FEED
- D² BLACKOUT LIGHTS FEED
- E¹ BLACKOUT DRIVING LIGHT FEED
- E² BLACKOUT DRIVING LIGHT FEED
- F¹ STOP LIGHT SWITCH FEED
- F² STOP LIGHT SWITCH FEED
- G¹ BLACKOUT STOP LIGHT FEED
- G² BLACKOUT STOP LIGHT FEED
- H¹ STOP LIGHT SWITCH RETURN
- H² STOP LIGHT SWITCH RETURN
- I¹ STOP LIGHT FEED
- I² STOP LIGHT FEED
- J¹ TRAILER TAILLIGHT FEED
- J² TRAILER TAILLIGHT FEED
- K¹ INSTRUMENT LAMP SWITCH FEED
- SERVICE TAILLIGHT FEED
- DIMMER SWITCH FEED
- K² INSTRUMENT LAMP SWITCH FEED
- K³ DIMMER SWITCH FEED
- K⁴ SERVICE TAILLIGHT FEED
- L¹ FUEL GAGE
- L² FUEL GAGE
- M¹ INSTRUMENT PANEL LIGHTS
- M² INSTRUMENT PANEL LIGHT
- M³ INSTRUMENT PANEL LIGHT
- M⁴ INSTRUMENT PANEL LIGHT
- N¹ FUEL GAGE FEED
- N² FUEL GAGE FEED
- O¹ DIM HEADLIGHT FEED
- O² DIM HEADLIGHT FEED
- P¹ BRIGHT HEADLIGHT FEED
- P² BRIGHT HEADLIGHT FEED
- Q¹ HORN BUTTON
- Q² HORN BUTTON

WIRE SIZE AND COLOR

- NO. 10 YELLOW
- NO. 10 YELLOW
- NO. 14 GREEN
- NO. 14 GREEN
- NO. 14 TAN-RED & BLACK CR. TR.
- NO. 14 TAN-RED & BLACK CR. TR.
- NO. 14 TAN-RED & BLACK CR. TR.
- NO. 14 TAN-RED & BLACK CR. TR.
- NO. 16 WHITE
- NO. 16 WHITE
- NO. 16 WHITE-BLACK TR.
- NO. 16 WHITE-BLACK TR.
- NO. 16 RED
- NO. 16 RED
- NO. 16 BLACK-RED TR.
- NO. 16 BLACK-RED TR.
- NO. 16 BLACK-RED CH.
- NO. 16 RED-BLACK TR.
- NO. 16 RED-BLACK TR.
- NO. 16 BLACK-GREEN CH.
- NO. 16 BLACK-GREEN CH.
- NO. 16 BLACK-GREEN TR.
- NO. 16 BLACK-GREEN TR.
- NO. 10 BLACK-GREEN TR.
- NO. 16 BLACK-GREEN TR.
- NO. 16 GREEN
- NO. 16 GREEN
- NO. 16 GREEN-BLACK CH.
- NO. 16 GREEN-BLACK CH.
- NO. 16 GREEN-BLACK CH.
- NO. 16 GREEN-BLACK CH.
- NO. 16 WHITE-RED TR.
- NO. 16 WHITE-RED TR.
- NO. 14 WHITE-GREEN TR.
- NO. 14 WHITE-GREEN TR.
- NO. 12 WHITE-BLACK CH. TR.
- NO. 12 WHITE-BLACK CH. TR.
- NO. 14 BLACK-WHITE TR.
- NO. 14 BLACK-WHITE TR.

TERMINAL

- LIGHT SWITCH "B"
- AMMETER
- AMMETER
- IGNITION SWITCH
- CIRCUIT BREAKER
- AMMETER
- CIRCUIT BREAKER
- NO. 2 UPPER JCT.
- LIGHT SWITCH "BHT"
- NO. 1 UPPER JCT.
- LIGHT SWITCH "BOD"
- NO. 3-3 POST JCT.
- LIGHT SWITCH "SW"
- NO. 3 LOWER JCT.
- LIGHT SWITCH "BS"
- NO. 6 LOWER JCT.
- LIGHT SWITCH "SS"
- NO. 5 LOWER JCT.
- LIGHT SWITCH "S"
- NO. 2 LOWER JCT.
- LIGHT SWITCH "TT"
- NO. 1 LOWER JCT.
- MAIN SWITCH "HT"
- MAIN SWITCH "HT"
- MAIN SWITCH "HT"
- PANEL SWITCH
- DIMMER SW. "BAT"
- NO. 5 UPPER JCT.
- GAGE "TANK"
- NO. 4 BOTTOM JCT.
- PANEL SWITCH
- LIGHT SOCKET
- LIGHT SOCKET
- LIGHT SOCKET
- IGN. SWITCH
- GAGE "IGN"
- NO. 3 UPPER JCT.
- DIMMER SW. "DIM"
- NO. 4 UPPER JCT.
- DIMMER SW. "BRT"
- STEERING COLUMN
- NO. 6 UPPER JCT.

RA PD 333000

Figure 120—Cab Wiring Harness (Rotary Main Light Switch)

TRUCK, 2½-TON, 6 x 6

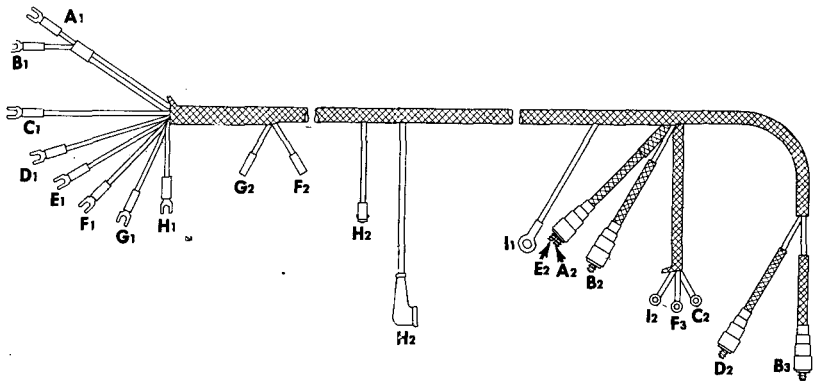

| SYMBOL | CIRCUIT | WIRE SIZE AND COLOR | TERMINAL |
|--------|-------------------------|------------------------------------|---------------------------------------|
| A1 | SERVICE TAILLIGHT | NO. 16 BLACK-GREEN TR. | NO. 5 TOP JCT. CONNECTOR |
| A2 | SERVICE TAILLIGHT | NO. 16 BLACK-GREEN TR. | NO. 1 TOP JCT. CONNECTOR |
| B1 | BLACKOUT TAILLIGHT | NO. 16 WHITE | |
| B2 | BLACKOUT TAILLIGHT—L.H. | NO. 16 WHITE | CONNECTOR |
| B3 | BLACKOUT TAILLIGHT—R.H. | | CONNECTOR |
| C1 | TRAILER TAILLIGHT | NO. 16 BLACK-GREEN CH. | NO. 1 BOTTOM JCT. TRAILER SOCKET "TL" |
| C2 | TRAILER TAILLIGHT | NO. 16 BLACK-GREEN CH. | NO. 6 BOTTOM JCT. CONNECTOR |
| D1 | BLACKOUT STOP LIGHT | NO. 16 BLACK-RED TR. | NO. 2 BOTTOM JCT. CONNECTOR |
| D2 | BLACKOUT STOP LIGHT | NO. 16 BLACK-RED TR. | NO. 5 BOTTOM JCT. STOP SWITCH |
| E1 | SERVICE STOP LIGHT | NO. 16 RED-BLACK TR. | TRAILER SOCKET "SL" |
| E2 | SERVICE STOP LIGHT | NO. 16 RED-BLACK TR. | NO. 3 BOTTOM JCT. STOP SWITCH |
| F1 | STOP LIGHT SWITCH | NO. 16 BLACK-RED CH. | NO. 4 BOTTOM JCT. |
| F2 | STOP LIGHT SWITCH | NO. 16 BLACK-RED CH. | |
| F3 | TRAILER STOP LIGHT | NO. 16 BLACK-RED CH. | |
| G1 | STOP LIGHT SWITCH | NO. 16 RED | |
| G2 | STOP LIGHT SWITCH | NO. 16 RED | |
| H1 | FUEL GAGE | NO. 16 BLACK-GREEN TR. (LONG W.B.) | NO. 4 BOTTOM JCT. |
| H1 | FUEL GAGE | NO. 16 GREEN (SHORT W.B.) | |
| H2 | FUEL GAGE | NO. 16 BLACK-GREEN TR. (LONG W.B.) | FUEL TANK UNIT |
| H2 | FUEL GAGE | NO. 16 GREEN (SHORT W.B.) | TANK JCT. |
| I1 | TRAILER SOCKET GROUND | NO. 12 BLACK | FRAME |
| I2 | TRAILER SOCKET GROUND | NO. 12 BLACK | TRAILER SOCKET "GR" |

RA PD 333001

Figure 121—Chassis Wiring Harness

(1) The circuit and terminal connection of any individual wire, within a harness, can be determined by referring to figures 119 to 123. Example—if wire is identified as being E-1 at one end, the opposite end will be E-2. Whenever one or more wires are spliced into "E" circuit, outlet ends of these wires would then be identified as E-3 or E-4. Wire size, color, circuit, and terminal connection of each wire is listed below each wiring harness illustration (figs. 119 to 123).

d. **Replacement.** Each individual wire or various harness assemblies can be removed by disconnecting at junction blocks, switches,

WIRING, HARNESES, AND CIRCUITS

gages, or other electrical units. Remove clips and grommets necessary to accomplish removal. When wires have been disconnected and clips or grommets removed, the wire or harness can then be completely removed. When installing, locate the wire or harness in its correct position, being sure that clips and grommets are installed. Attach individual wires to the respective unit or junction block terminal. Tighten connections. Bear in mind: *A clean and tight electrical connection is a good connection.*

(1) **CAB WIRING HARNESS** (figs. 119 and 120). Two cab wiring harnesses have been used with these vehicles. The first (fig. 119), is used only with vehicles having a push-pull main light switch. The second (fig. 120), is used only with vehicles having a rotary main light switch. This harness, identified by yellow tracer in the loom, extends from junction blocks on front of dash (fig. 118), through hole in dash, then to instruments, gages, and switches at rear of instrument board (figs. 116 and 117). Raise engine hood to gain access to junction blocks. Remove instrument panel cluster assembly (par. 136) to gain access to electrical units terminal.

(2) **CHASSIS WIRING HARNESS** (fig. 121). This harness, identified by a red tracer in the loom, extends from junction blocks on front of dash (fig. 118), to stop light switch, fuel tank gage, stop and

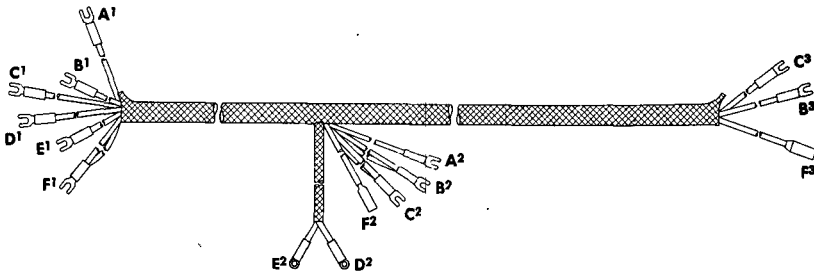

SYMBOL AND CIRCUIT

- A¹ BLACKOUT DRIVING LIGHT
- A² BLACKOUT DRIVING LIGHT
- B¹ HEADLIGHT —HIGH
- B² HEADLIGHT —HIGH
- B² HEADLIGHT —HIGH
- B³ HEADLIGHT —HIGH
- C¹ HEADLIGHT —LOW
- C² HEADLIGHT —LOW
- C² HEADLIGHT —LOW
- C³ HEADLIGHT —LOW
- D¹ HORN FEED
- D² HORN FEED
- E¹ HORN RETURN
- E² HORN RETURN
- F¹ BLACKOUT MARKER LIGHT—L.H.
- F² BLACKOUT MARKER LIGHT—L.H.
- F² BLACKOUT MARKER LIGHT—L.H.
- F³ BLACKOUT MARKER LIGHT—R.H.

WIRE SIZE AND COLOR

- NO. 16 WHITE-BLACK TR.
- NO. 16 WHITE-BLACK TR.
- NO. 12 WHITE-BLACK CR. TR.
- NO. 12 WHITE-BLACK CR. TR.
- NO. 14 WHITE-BLACK CR. TR.
- NO. 14 WHITE-BLACK CR. TR.
- NO. 14 WHITE-BLACK CR. TR.
- NO. 14 WHITE-GREEN TR.
- NO. 14 WHITE-GREEN TR.
- NO. 16 WHITE-GREEN TR.
- NO. 16 WHITE-GREEN TR.
- NO. 14 OR 16 TAN-RED AND BLACK CR. TR.
- NO. 14 OR 16 TAN-RED AND BLACK CR. TR.
- NO. 14 OR 16 BLACK
- NO. 14 OR 16 BLACK
- NO. 16 WHITE
- NO. 16 WHITE
- NO. 16 WHITE
- NO. 16 WHITE

TERMINAL

- NO. 3 - 3 POST JCT.
- L.H. JCT. BLOCK
- NO. 4 TOP JCT.
- L.H. JCT. BLOCK
- L.H. JCT. BLOCK
- R.H. JCT. BLOCK
- NO. 3 TOP JCT.
- L.H. JCT. BLOCK
- L.H. JCT. BLOCK
- R.H. JCT. BLOCK
- NO. 2 TOP JCT.
- HORN
- NO. 6 TOP JCT.
- HORN
- NO. 1 TOP JCT.
- NO. 1 TOP JCT.
- L.H. CONNECTOR
- R.H. CONNECTOR

Figure 122—Front End Wiring Harness

RA PD 333010

TRUCK, 2½-TON, 6 x 6

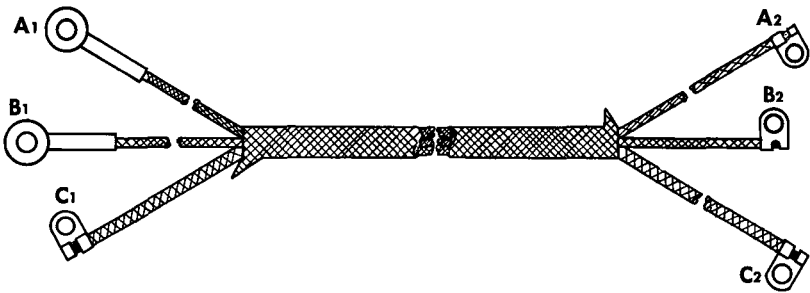

| SYMBOL | CIRCUIT | WIRE SIZE AND COLOR | TERMINAL |
|--------|--------------------|----------------------------------|-----------------|
| A1 | GROUND | NO. 14 BLACK | GEN. "GRD" |
| A2 | GROUND | NO. 14 BLACK | REG. "GRD" |
| B1 | GENERATOR FIELD | NO. 14 BLACK-RED CH. | GEN. "FLD" |
| B2 | GENERATOR FIELD | NO. 14 BLACK-RED CH. | FIELD FILTER |
| C1 | GENERATOR ARMATURE | NO. 8 TAN-RED AND BLACK X TR. | GEN. "ARM" |
| C2 | GENERATOR ARMATURE | NO. 8 TAN-RED AND BLACK X TR. | ARMATURE FILTER |

RA PD 64640

Figure 123—Generator to Regulator and Filters Wiring Harness

taillights, and trailer socket. Harness is located under cab floor boards at front end, then along inside of left-hand frame side rail to the rear of vehicle.

(3) **FRONT END WIRING HARNESS** (fig. 122). This harness extends from junction blocks on front of dash (fig. 118) to horn, right and left headlight junction blocks, and marker light connectors. Harness is located along inside of left-hand fender skirt and over radiator to right-hand head light junction block, on inside of right-hand fender skirt.

(4) **GENERATOR TO REGULATOR AND FILTERS WIRING HARNESS** (fig. 123). This harness extends from generator, along inside of left-hand fender skirt, to regulator and filters on front of dash (fig. 118). Raise engine hood to gain access to harness assembly and attaching units.

Section XXIV

RADIO NOISE SUPPRESSION SYSTEM

129. DESCRIPTION AND DATA.

a. **Description.** Radio noise suppression is the suppression of noise disturbances in the electrical system of the vehicle, which

RADIO NOISE SUPPRESSION SYSTEM

would interfere with proper reception of radio signals, or permit detection of the vehicle location by highly sensitive receivers. The sources of electrical interference originate in the following: Ignition System, Generating System, Battery Circuit, Lighting System and static caused by friction.

(1) Radio frequency waves given off by these systems during operation are radiated or broadcast as radio waves, or signals, that interfere with any receiving apparatus in the vicinity. Radio noise suppression, therefore, involves the suppression of these waves at their source or confining them within an area where they cannot be picked up by the antenna of a radio.

(2) Suppression is accomplished by the use of suppressors, condensers and filters. In addition, internal and/or external toothed lock washers are used at mounting points of these units to securely ground them and thus further eliminate electrical noises. In addition to these units, engine compartment is bonded by the use of internal and/or external toothed lock washers and bond straps to form a "box" within which radio frequency waves are trapped to prevent their escape.

b. Data.

(1) **FILTERS.**

| | |
|--------------------------------|------------|
| Make | Delco-Remy |
| <i>Model</i> | |
| Regulator Armature | 1888263 |
| Field Circuit | 1888796 |
| Battery Circuit | 1888795 |
| Ignition Primary Circuit | 1889530 |

(2) **CONDENSERS.**

| | |
|---------------------------|--------------------|
| Make | Delco-Remy |
| <i>Model</i> | |
| Generator | 1888918 or 1901731 |
| Headlights | 1889319 or 1901696 |
| Stop and Taillights | 1901696 |
| Cranking Motor | 1901681 |

(3) **SUPPRESSORS.**

| | |
|-------------|------------|
| Make | Delco-Remy |
| Model | 1887829 |

130. BODY AND CHASSIS BONDING.

a. General. In addition to filters, condensers, and suppressors, internal-external toothed lock washers and bond straps are also used at points shown in figures 124 and 125 to eliminate static discharges from the vehicle and to form a "box" around electrical units and prevent escape of radio frequency waves. Localized views of lock washer and bond strap installations are shown in figures 126 and 127.

b. Lock Washers. Internal-external toothed lock washers are used at points indicated in figures 124 and 125. Refer to text under illustrations to determine type of mounting used at any given loca-

TRUCK, 2½-TON, 6 x 6

RA PD 332999

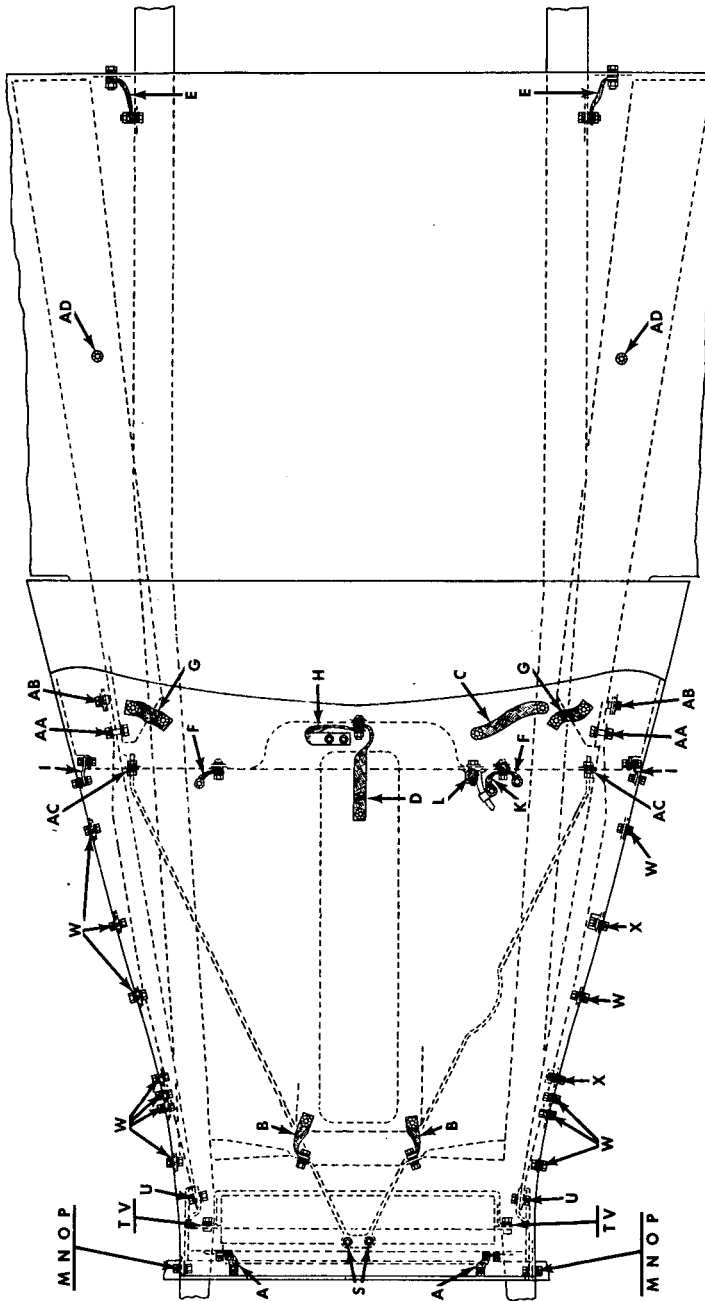

Figure 124—Bond Straps and Toothed Lock Washer Installation (Plan View)

RADIO NOISE SUPPRESSION SYSTEM

BOND STRAPS

| SYMBOL | DESCRIPTION | MOUNTING (See fig. 127) | SYMBOL | DESCRIPTION | MOUNTING (See fig. 127) |
|--------|---|----------------------------|--------|---|----------------------------|
| A | FROM—RADIATOR TANK TO—RADIATOR SUPPORT ASSEMBLY TO—RADIATOR SUPPORT—LOWER | B-6 B-7 B-8 | G | FROM—CAB SILL TO—FRAME | B-9 B-9 |
| B | FROM—ENGINE OIL PAN TO—FRAME | B-4 B-5 | H | FROM—DASH PANEL TO—THROTTLE AND CHOKE CABLES TO—TEMPERATURE GAGE TUBE | B-13 B-14 B-14 |
| C | FROM—FLYWHEEL HOUSING TO—FRAME | B-4 B-5 | I | FROM—HOOD SIDE PANEL TO—DASH PANEL | B-2 B-2 |
| D | FROM—VALVE COVER BOLT TO—DASH PANEL | B-12 B-13 | K | FROM—SPEEDOMETER CABLE TO—DASH PANEL | B-11 B-3 |
| E | FROM—REAR OF CAB TO—STEP HANGER | B-15 B-16 | L | FROM—OIL PRESSURE TUBE TO—SPEEDOMETER CABLE (SOME MODELS) TO—DASH PANEL | B-17 B-11 B-17 |
| F | FROM—HOOD TO—DASH PANEL—R.H. TO—DASH PANEL—L.H. | B-1 B-2 B-3 | | | |

TOOTHED LOCK WASHER

| SYMBOL | DESCRIPTION | MOUNTING (See fig. 126) | SYMBOL | DESCRIPTION | MOUNTING (See fig. 126) |
|--------|--------------------------------|----------------------------|--------|-------------------------------------|----------------------------|
| M | BRUSH GUARD TO SIDE PANEL | L-1 | V | FAN SHROUD TO RADIATOR SUPPORT | L-10 |
| N | BRUSH GUARD TO SIDE PANEL | L-2 | W | FENDER TO SKIRT | L-11 |
| O | BRUSH GUARD TO SIDE PANEL | L-3 | X | FENDER TO SKIRT—L.H. | L-12 |
| P | BRUSH GUARD TO SIDE PANEL | L-4 | AA | RADIATOR SUPPORT BRACE TO SIDE SILL | L-15 |
| S | RADIATOR TIE ROD—FRONT | L-7 | AB | FENDER SKIRT TO COWL | L-16 |
| T | FAN SHROUD TO RADIATOR SUPPORT | L-8 | AC | RADIATOR TIE ROD TO COWL | L-17 |
| U | RADIATOR SUPPORT BRACE | L-9 | AD | CAB TO SILL | L-18 |

Legend for Figure 124

RA PD 332999B

TRUCK, 2 1/2-TON, 6 x 6

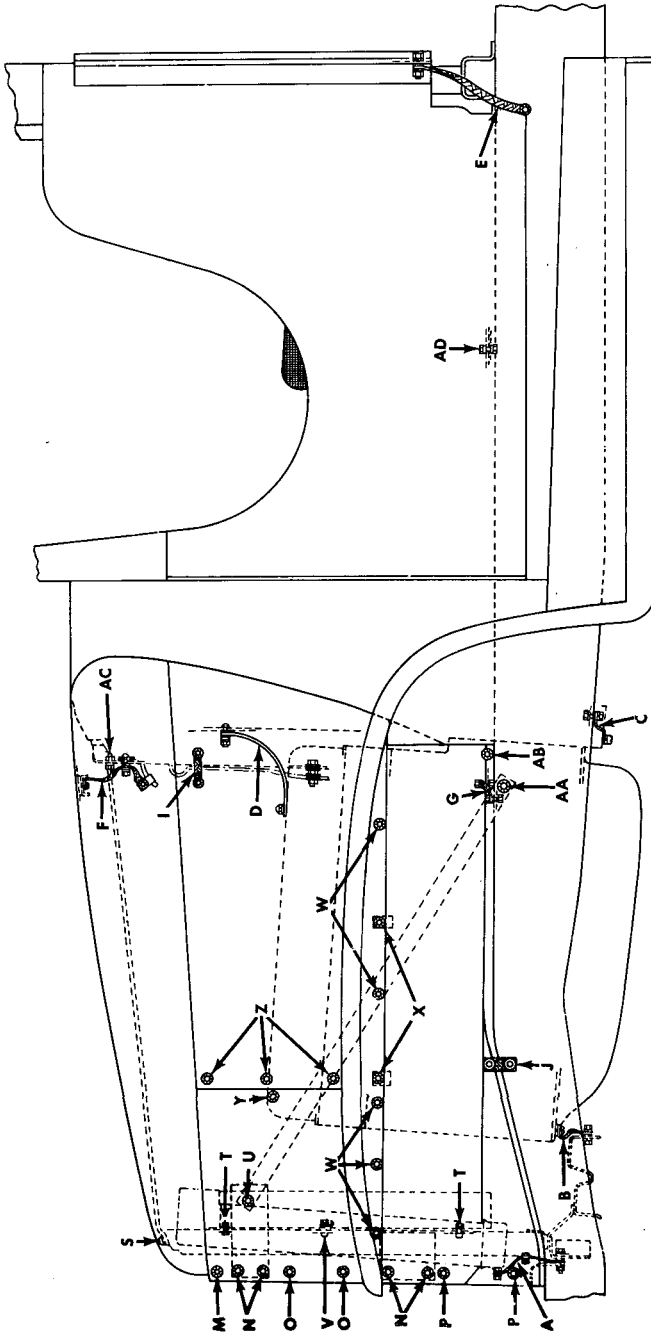

RA PD 333047

Figure 125—Bond Straps and Toothed Lock Washer Installation (Side View)

RADIO NOISE SUPPRESSION SYSTEM

BOND STRAPS

| SYMBOL | DESCRIPTION | MOUNTING (See fig. 127) | SYMBOL | DESCRIPTION | MOUNTING (See fig. 127) |
|--------|---|----------------------------|--------|---|----------------------------|
| A | FROM—RADIATOR TANK TO—RADIATOR SUPPORT ASSEMBLY TO—RADIATOR SUPPORT—LOWER | B-6 B-7 B-8 | F | FROM—HOOD TO—DASH PANEL—R.H. TO—DASH PANEL—L.H. | B-1 B-2 B-3 |
| B | FROM—ENGINE OIL PAN TO—FRAME | B-4 B-5 | G | FROM—CAB SILL TO—FRAME | B-9 B-9 |
| C | FROM—FLYWHEEL HOUSING TO—FRAME | B-4 B-5 | I | FROM—HOOD SIDE PANEL TO—DASH PANEL | B-2 B-2 |
| D | FROM—VALVE COVER BOLT TO—DASH PANEL | B-12 B-13 | J | FROM—FENDER SKIRT TO—FRAME | B-10 B-9 |
| E | FROM—REAR OF CAB TO—STEP HANGER | B-15 B-16 | | | |

TOOTHED LOCK WASHER

| SYMBOL | DESCRIPTION | MOUNTING (See fig. 126) | SYMBOL | DESCRIPTION | MOUNTING (See fig. 126) |
|--------|--------------------------------|----------------------------|--------|-------------------------------------|----------------------------|
| M | BRUSH GUARD TO SIDE PANEL | L-1 | V | FAN SHROUD TO RADIATOR SUPPORT | L-10 |
| N | BRUSH GUARD TO SIDE PANEL | L-2 | W | FENDER TO SKIRT | L-11 |
| O | BRUSH GUARD TO SIDE PANEL | L-3 | X | FENDER TO SKIRT—L.H. | L-12 |
| P | BRUSH GUARD TO SIDE PANEL | L-4 | Y | HOOD SIDE PANEL TO SUPPORT BRACE | L-13 |
| Q | BRUSH GUARD TO FENDER—OUTER | L-5 | Z | HOOD FRONT TO REAR SIDE PANEL | L-14 |
| R | BRUSH GUARD TO FENDER—INNER | L-6 | AA | RADIATOR SUPPORT BRACE TO SIDE SILL | L-15 |
| S | RADIATOR TIE ROD—FRONT | L-7 | AB | FENDER SKIRT TO COWL | L-16 |
| T | FAN SHROUD TO RADIATOR SUPPORT | L-8 | AC | RADIATOR TIE ROD TO COWL | L-17 |
| U | RADIATOR SUPPORT BRACE | L-9 | AD | CAB TO SILL | L-18 |

Legend for Figure 125

RA PD 333047B

TRUCK, 2 1/2-TON, 6 x 6

tion. Then refer to figure 126 for sectional views showing lock washer locations in relation to other parts used at that particular point.

(1) **INSTALLATION.** Whenever it is necessary to remove any mounting where lock washers are used it is extremely important that it be reinstalled exactly as indicated in figure 126. It should be noted that lock washer is used under head of bolt or screw and under nut. At points where bond straps are used, additional lock washer is used between strap and other metal surface. Whenever it is necessary to install new parts, it is extremely important that cadmium plated lock washers be used. Never substitute with plain or parkerized parts. Be sure to destroy defective parts.

c. **Bond Straps.** Bond straps are used at points indicated in figures 124 and 125. Refer to text under illustrations to determine type of mounting used at any given location. Then refer to figure 127 for sectional views showing location of lock washers and method of attaching bond strap at that particular point.

(1) **INSPECTION.** Inspect all bond strap attachments to be sure that bond strap materials are not broken and that mounting bolts and nuts are drawn up tight. **IMPORTANT:** It is extremely important that all straps be in good condition so as to form a good ground. If a single strap is damaged, broken or otherwise defective, it will result in faulty radio reception or interference with other receiving apparatus.

(2) **INSTALLATION.** Whenever it is necessary to remove a bond strap it is extremely important that it be reinstalled exactly as indicated in figure 127. In some instances two views are shown for a single mounting. This is necessary due to changes in the method of mounting; therefore, always compare illustrations with mounting on vehicle at time of removal and reinstall exactly as illustrated. Always

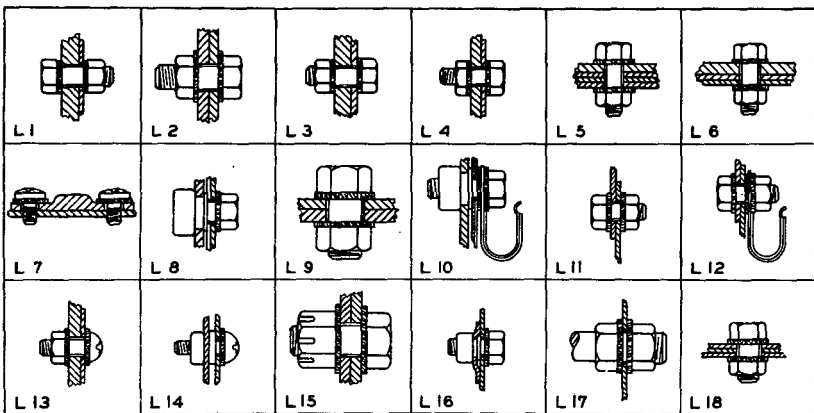

RA PD 64644

Figure 126—Sections of Internal and/or External Toothed Lock Washer Installation

RADIO NOISE SUPPRESSION SYSTEM

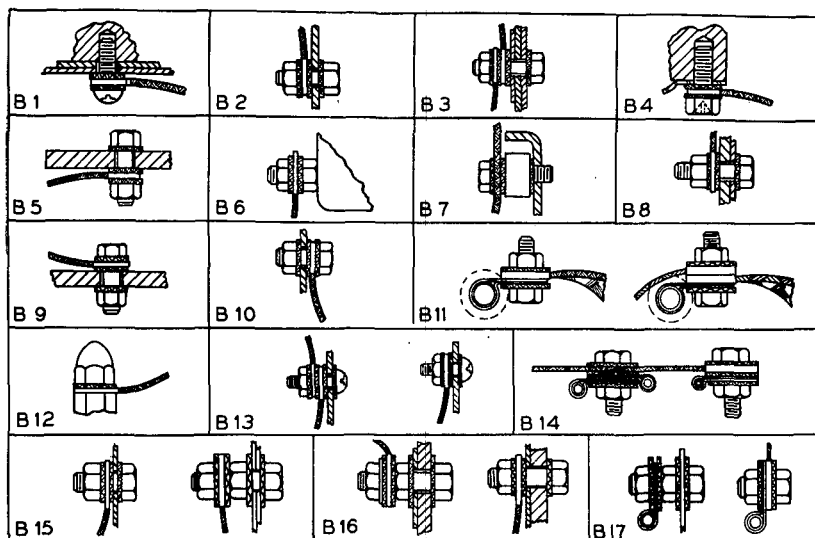

RA PD 332975

Figure 127—Sections of Bond Strap Mountings

use cadmium plated bolts and nuts when installing bond straps. Never substitute plain or parkerized parts.

131. IGNITION CIRCUIT.

a. **General.** Suppression of noises arising from ignition circuit is accomplished by the use of ignition primary circuit filter, spark plug and secondary wire suppressors, also internal-external toothed lock washers at ignition coil mounting bracket.

b. Ignition Primary Circuit Filter.

(1) **TEST.** Filter should be tested to be sure that it provides a continuous circuit from terminal to terminal and that no internal shorts or grounds exist.

(a) **Continuous Circuit Test.** Disconnect wires from both terminals and connect test light between two terminals. If light does not light it indicates that there is an "open circuit" within filter, and unit must be replaced.

(b) **Test for Short.** Disconnect wires from both terminals and connect one test light lead to one of the terminals while other lead contacts filter body. If light works, it indicates that there is a short and unit must be replaced. Follow this same procedure on other terminal.

(2) **REMOVAL.**

(a) **Remove Wires.** Remove screw at two terminals then lift wires from terminals.

TRUCK, 2½-TON, 6 x 6

(b) *Remove Filter.* Remove two nuts and lock washers from mounting bolts at inside of cab dash. Remove two bolts and flat washers attaching filter to front of dash. Remove filter and mounting bracket from dash, noting that lock washer is used between filter mounting bracket and dash.

(3) **INSTALLATION.**

(a) *Clean Mounting Surface.* Clean mounting surface of filter bracket and front of dash to remove all dirt, paint, grease or other foreign matter.

(b) *Install Filter.* Position filter and mounting bracket against front of dash, using internal-external toothed lock washers between filter mounting bracket and dash. Install bolts through filter mounting bracket and dash, using flat washers under head of bolts. Install external toothed lock washers and nuts to bolts at inside of dash. Tighten nuts.

(c) *Connect Wires.* Attach ignition switch to filter and ignition coil to filter wires (No. 14 Black) to filter terminals. Use external toothed lock washer between wire terminal and filter. Tighten terminal screw.

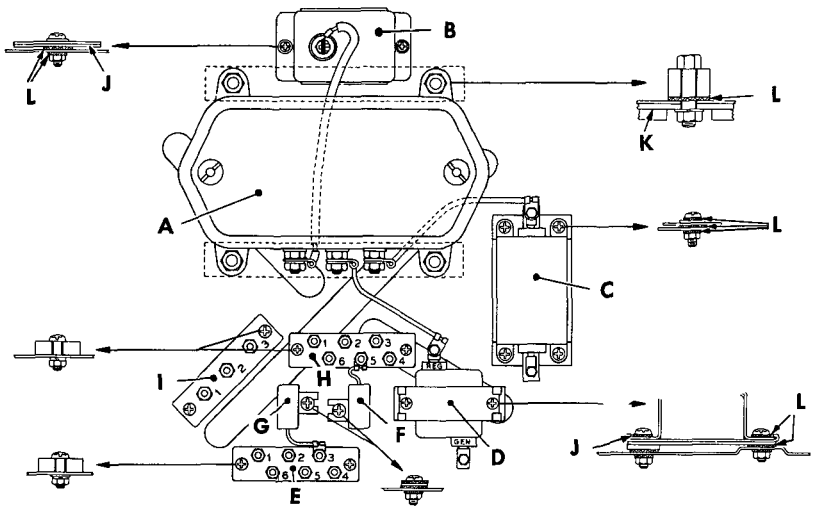

- | | |
|-------------------------------|--------------------------------|
| A REGULATOR | G TRAILER STOP LIGHT CONDENSER |
| B BATTERY CIRCUIT FILTER | H JUNCTION BLOCK—TOP |
| C ARMATURE CIRCUIT FILTER | I JUNCTION BLOCK—3 POST |
| D FIELD CIRCUIT FILTER | J FILTER REINFORCEMENT |
| E JUNCTION BLOCK—BOTTOM | K REGULATOR REINFORCEMENT |
| F SERVICE TAILLIGHT CONDENSER | L TOOTHED LOCK WASHER |

Figure 128—Regulator, Filters, and Condenser Mounting

RA PD 333063

RADIO NOISE SUPPRESSION SYSTEM

c. **Ignition Coil.** When ignition coil is removed (par. 90), it is imperative that internal-external toothed lock washers be used under mounting stud nuts at time of installation (par. 90).

132. GENERATING CIRCUIT.

a. **General.** Radio suppression of the generating circuit is accomplished through the use of three filters mounted on front of dash (fig. 128) and condenser at generator (fig. 129). Internal-external toothed lock washers used at regulator and filter mounting are also essential to suppression of radio noises.

b. Filters.

(1) **TEST.** Refer to paragraph 131 b (1) for testing procedure.

(2) **REMOVAL.**

(a) **Remove Wires.** Remove screw at two terminals, then lift wires from terminals.

(b) **Remove Filter.** Remove two nuts and lock washers (four at armature circuit filter) from mounting bolts at inside of cab dash. Remove bolts and lock washers attaching filter to front of dash. Remove filter and mounting bracket from dash, noting that lock washer is used between filter mounting bracket and dash. Spacer is also used at one side of field circuit filter.

(3) **INSTALLATION.**

(a) **Clean Mounting Surface.** Clean mounting surfaces of filter mounting bracket, and front of dash to remove all dirt, paint, grease or other foreign matter.

(b) **Install Filter** (fig. 128). Position filter and mounting bracket against front of dash, using internal-external toothed lock washer between mounting bracket and dash. Spacer is also used at one side of field filter. Install bolts through filter, mounting bracket, and dash, using external toothed lock washers under head of bolts. Install external toothed lock washers and nuts to bolts at inside of dash. Tighten nuts.

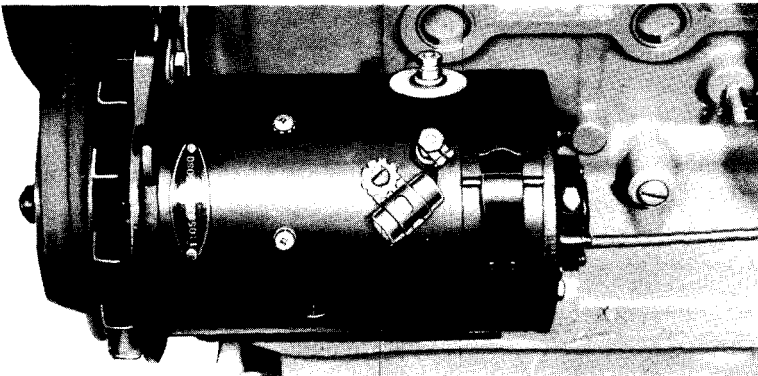

RA PD 332983

Figure 129—Condenser Installation at Generator

TRUCK, 2½-TON, 6 x 6

(c) *Install Wires.* Attach wires to filter terminals. Refer to figures 113 and 114 for wire identification and connections. Use external toothed lock washer between wire terminal and filter. Tighten terminal screw.

c. Condenser.

(1) **REMOVAL** (fig. 129). Remove nut and lock washer from generator "ARM" terminal. Lift wires from terminal. Remove screw and lock washers attaching ground wire and condenser to generator. Lift condenser from generator.

(2) **TEST.** Testing of condenser must be accomplished with a condenser tester (17-T-5541). Each factor affecting condenser operation must be considered when making tests. Condensers used on this vehicle should meet following specifications: Megohms 6000; Capacity 0.085 - 0.13 MFD; Flash 600 Volts DC.

(3) **INSTALLATION** (fig. 129). Clean all contact surfaces and wire terminals. Attach condenser and ground wire (No. 14 Black) to generator, using screw and two internal-external toothed lock washers. Tighten screw. Attach condenser pig-tail wire and armature wire (No. 8 Tan-Red and Black Cr. Tr.), to "ARM" terminal, using nut and lock washer. Tighten nut.

133. BATTERY CIRCUIT.

a. General. Radio suppression of the battery or cranking motor circuit is accomplished through the use of a condenser, mounted on cranking motor housing and connected to cranking motor switch

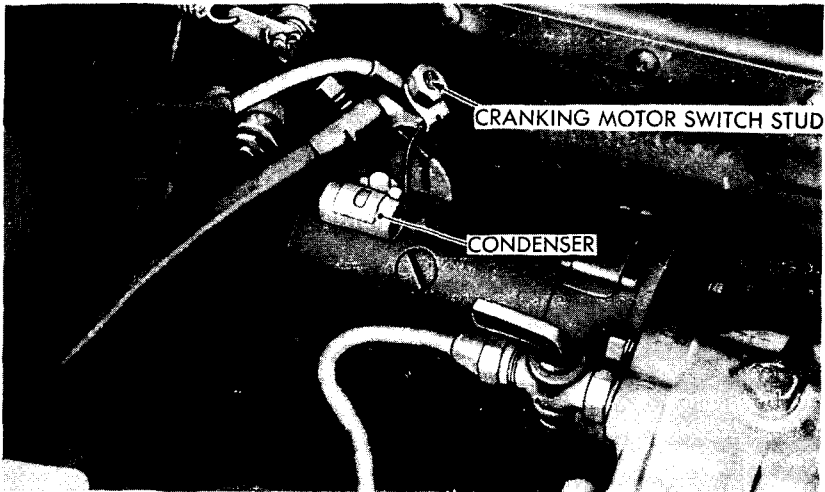

RA PD 333061
Figure 130—Condenser Installation at Cranking Motor

RADIO NOISE SUPPRESSION SYSTEM

(fig. 130). Condenser bypasses and grounds static waves which would flow into battery and up the lead to the radio receiver.

b. Condenser.

(1) **REMOVAL** (fig. 130). Remove nut and lock washer from cranking motor switch terminal. Lift condenser pig-tail wire from terminal. Remove screw and lock washer attaching condenser and switch to cranking motor housing.

(2) **TEST.** Refer to paragraph 132 c (2).

(3) **INSTALLATION** (fig. 130). Clean all contact surfaces and wire terminals. Attach condenser to cranking motor housing, using screw and internal-external toothed lock washer. Tighten screw. Position condenser pig-tail over cranking motor switch stud and install lock washer and nut. Tighten nut.

134. LIGHTING CIRCUIT.

a. **General.** Radio suppression of lighting circuit is accomplished by use of four condensers, two at right-hand headlight junction block (fig. 131) and two at junction blocks on front of dash (fig. 128).

b. Condenser.

(1) **REMOVAL** (fig. 131). Remove nut and lock washer attaching condenser pig-tail to junction block terminal. Remove nut and lock washer attaching condenser to dash or fender skirt. Remove bolt, lock washers, and condenser. During removal note location and type of lock washer, so that same type can be reinstalled in its correct location.

(2) **TEST.** Refer to paragraph 132 c (2).

(3) **INSTALLATION** (fig. 131). Clean all contact surfaces and wire terminals. Locate condenser in its correct position and attach

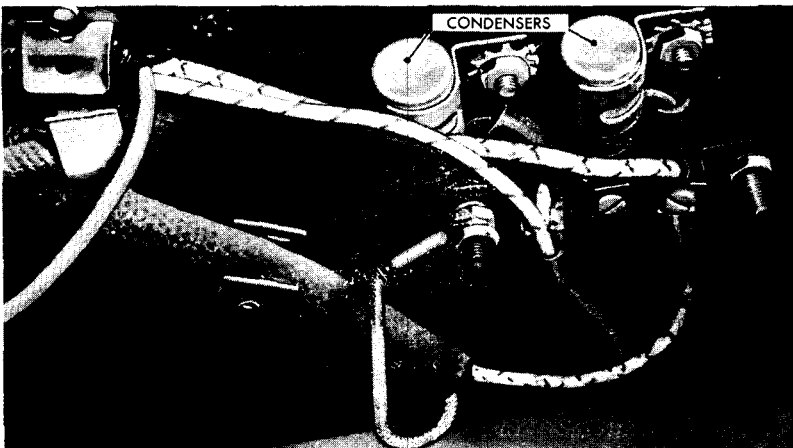

Figure 131—Headlight Beam Condenser Installation

RA PD 64719

TRUCK, 2½-TON, 6 x 6

with bolt and nut. Be sure that internal-external toothed lock washers are used under head of bolt and at each side of condenser bracket; except at junction block condensers which use external toothed lock washer under nut at inside of dash. Tighten nuts securely.

Section XXV

INSTRUMENTS, GAGES, AND SWITCHES

135. GENERAL.

a. The gages and panel lights are grouped in an instrument panel which is mounted on instrument board in front of driver. The switches, circuit breaker, throttle control, and choke control are mounted along the lower edge of the instrument board.

b. **Early and Late Types.** Early vehicles were equipped with a push-pull type main light switch with a separate switch for the blackout driving light (fig. 132). Latest vehicles are equipped with a rotary type main light switch incorporating contacts for blackout driving light. Separate blackout light switch is therefore eliminated and ignition switch and main light switch are relocated (fig. 134).

c. **CAUTION:** Disconnect battery cable at battery before tightening instrument mountings or electrical connections, and when replacing units to prevent damage due to shorting the electrical circuits.

136. INSTRUMENT PANEL ASSEMBLY.

a. **Instrument Panel Removal** (figs. 15, 132, 133, and 134).

(1) **DISCONNECT BATTERY CABLE.** Disconnect battery cable from battery terminal before attempting removal of instrument panel.

(2) **DISCONNECT THERMAL UNIT AT ENGINE.** Unscrew thermo gage thermal unit from cylinder head fitting. Either drain cooling system until coolant level is below level of thermal unit, or plug cylinder head fitting immediately after removal of thermal unit. Remove bond strap, remove grommet from around capillary tube at dash, and push tube and thermal unit through hole in dash.

(3) **DISCONNECT OIL PRESSURE GAGE TUBE.** Unscrew tubing nut attaching oil tube to back of gage.

(4) **DISCONNECT SPEEDOMETER CABLE.** Unscrew knurled nut at back of speedometer head and pull cable free from speedometer. Remove nut and washer attaching wiring harness clip to speedometer mounting clamp and free harness clip from speedometer stud.

INSTRUMENTS, GAGES, AND SWITCHES

(5) **REMOVE INSTRUMENT PANEL MOUNTING SCREWS.** Remove five nuts, lock washers, and screws attaching instrument panel to instrument board. Push on face of instrument panel to tilt panel downward.

(6) **DISCONNECT WIRING AND REMOVE PANEL.** Disconnect wiring at all terminals at back of instrument panel. Pull on wires at back of three panel lights to disconnect. Remove instrument panel from vehicle.

b. Instrument Panel Installation (figs. 15, 132, 133, and 134).

(1) **POSITION INSTRUMENT PANEL IN INSTRUMENT BOARD.** Position instrument panel in tilted position in instrument board from back.

(2) **CONNECT WIRING.** Connect wiring to fuel gage as described in paragraph 140 c (2). Connect the No. 8 yellow, No. 10 yellow, and No. 14 green wires to ammeter terminal farthest from fuel gage; connect the other wires to the other ammeter terminal. Connect panel lights by pushing socket and lamp at end of each wire into shield in instrument panel.

(3) **ATTACH INSTRUMENT PANEL TO INSTRUMENT BOARD.** Position instrument panel in instrument board and install five attaching screws, lock washers, and nuts.

(4) **CONNECT SPEEDOMETER CABLE.** Fit cable shaft tongue into fitting in speedometer head. Pull cable casing against speedometer head and connect by tightening knurled nut on speedometer head fitting. Position wiring harness and clip on speedometer head stud and install lock washer and nut.

(5) **CONNECT OIL PRESSURE GAGE TUBE.** Position flanged end of tube against fitting at back of oil pressure gage. Screw tubing nut on gage fitting and tighten nut carefully to prevent leakage.

(6) **INSTALL THERMAL UNIT IN ENGINE.** Insert thermal unit and capillary tube through hole in cowl. Screw thermal unit into cylinder head fitting and tighten firmly, then fill cooling system (par. 17). Fit grommet around capillary tube and attach to dash, then attach bond strap to tube.

137. SPEEDOMETER AND DRIVE CABLE.

a. Speedometer Head Removal (figs. 132, 133, and 134).

(1) **DISCONNECT CABLE AT SPEEDOMETER HEAD.** At rear side of speedometer head, unscrew knurled nut attaching cable to head. Pull cable free.

(2) **REMOVE SPEEDOMETER HEAD.** Remove two nuts attaching mounting clamp to speedometer. Remove wiring harness clip. Take off mounting clamp and press on rear of speedometer head to remove from front of instrument board.

b. Speedometer Head Installation (figs. 132, 133, and 134).

(1) **INSTALL SPEEDOMETER HEAD.** Position speedometer head in instrument panel from front side of panel. Install mounting clamp over studs at back of speedometer. Position wiring harness clip over upper stud. Install two nuts and tighten securely.

TRUCK, 2 1/2-TON, 6 x 6

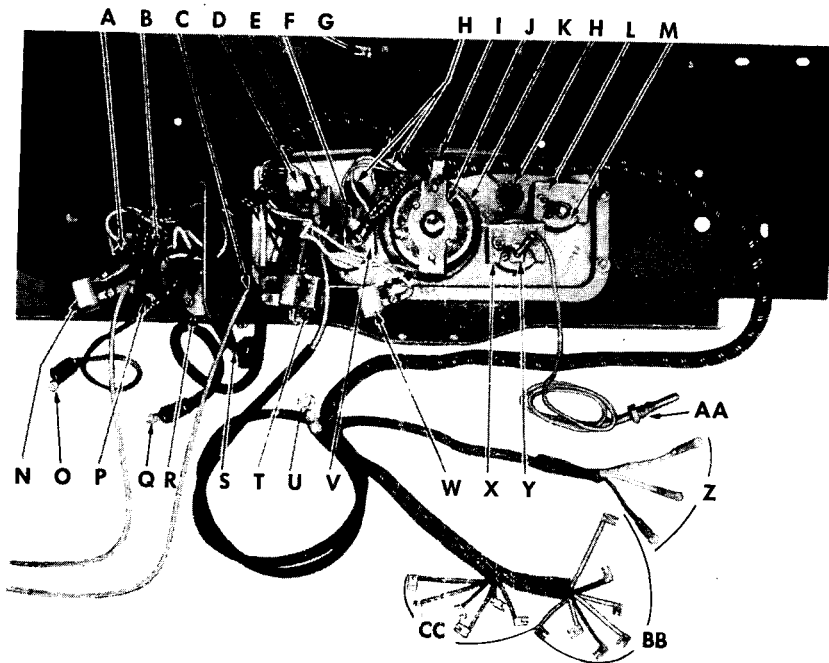

- | | |
|---|--|
| A HORN CIRCUIT BREAKER | R IGNITION SWITCH |
| B FUEL GAGE CIRCUIT BREAKER (EARLY MODELS) | S COWL VENTILATOR OPERATING LEVER |
| C THROTTLE CONTROL | T MAIN LIGHT SWITCH |
| D AMMETER | U WIRING TERMINAL (TO SWITCH ON CRANKING MOTOR) |
| E AMMETER CLAMP | V FUEL GAGE CLAMP |
| F FUEL GAGE | W BLACKOUT DRIVING LIGHT SWITCH |
| G WIRING TERMINAL (TO HORN TERMINAL ON STEERING COLUMN) | X WATER TEMPERATURE GAGE CLAMP |
| H INSTRUMENT PANEL LIGHTS | Y WATER TEMPERATURE GAGE |
| I WIRING HARNESS CLIP | Z WIRING TERMINALS (TO DIMMER SWITCH) |
| J SPEEDOMETER CLAMP | AA TEMPERATURE GAGE THERMAL UNIT |
| K SPEEDOMETER | BB WIRING TERMINALS (TO JUNCTION BLOCK ON COWL) |
| L OIL PRESSURE GAGE CLAMP | CC WIRING TERMINALS (TO JUNCTION BLOCK ON COWL) |
| M OIL PRESSURE GAGE | |
| N INSTRUMENT PANEL LIGHT SWITCH | |
| O WIRING TERMINAL (TO IGNITION PRIMARY CIRCUIT FILTER ON COWL) | |
| P CHOKE CONTROL | |
| Q WIRING TERMINAL (TO BATTERY CIRCUIT FILTER ON COWL) | |

Figure 132—Instrument Panel, Gages, and Switches—Rear View
(Push-Pull Main Light Switch) RA PD 333064

INSTRUMENTS, GAGES, AND SWITCHES

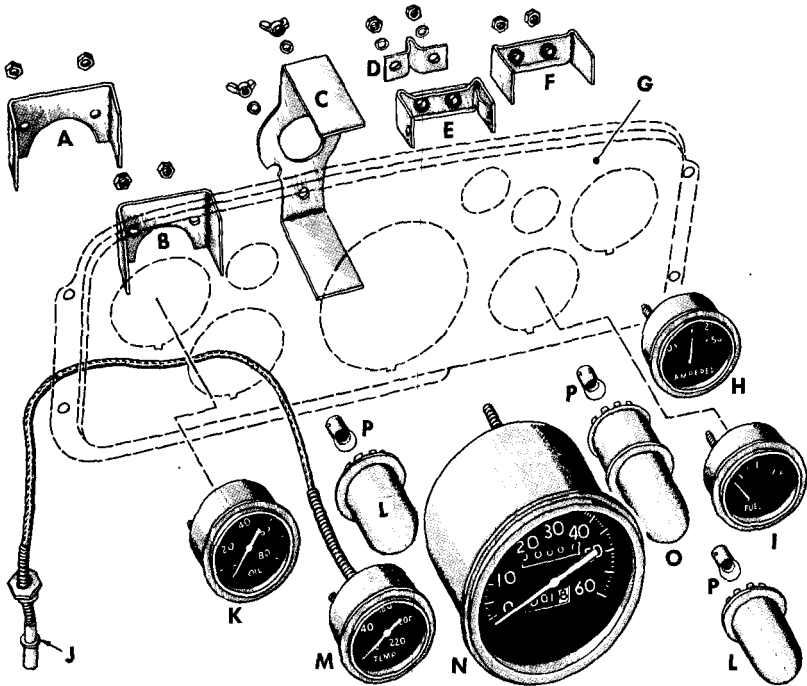

- | | |
|------------------------------------|------------------------------------|
| A OIL PRESSURE GAGE CLAMP | I FUEL GAGE |
| B WATER TEMPERATURE GAGE CLAMP | J TEMPERATURE GAGE THERMAL UNIT |
| C SPEEDOMETER CLAMP | K OIL PRESSURE GAGE |
| D FUEL GAGE FIBRE INSULATOR | L PANEL LIGHT SHIELD |
| E FUEL GAGE CLAMP | M WATER TEMPERATURE GAGE |
| F AMMETER CLAMP | N SPEEDOMETER |
| G INSTRUMENT CLUSTER PANEL OUTLINE | O PANEL LIGHT SHIELD AND EXTENSION |
| H AMMETER | P PANEL LAMP |

RA PD 64639

Figure 133—Instrument Panel and Related Parts

(2) **CONNECT SPEEDOMETER CABLE TO SPEEDOMETER HEAD.** Insert drive shaft tongue into fitting at rear of speedometer head and pull drive shaft casing against fitting. Attach by tightening knurled nut on speedometer head.

c. Speedometer Drive Cable Removal.

(1) **DISCONNECT CABLE AT SPEEDOMETER.** Unscrew knurled nut at back of speedometer head and pull drive cable free from speedometer.

(2) **REMOVE CABLE CLIPS.** Remove nuts, washers, bolts, and

TRUCK, 2½-TON, 6 x 6

clips attaching cable casing to cowl, frame side rail, and transfer case support.

(3) **DISCONNECT CABLE AT TRANSFER CASE.** Unscrew knurled nut attaching cable to transfer case. Pull drive cable free from transfer case.

(4) **REMOVE SPEEDOMETER CABLE.** Pull end of cable through dash panel after loosening grommet. Grip cable midway between ends and pull to remove cable [GM-1566712 casing; GM-1566714 (G85-30-05290) shaft] from vehicle.

d. Speedometer Drive Cable Installation.

(1) **INSTALL CABLE IN VEHICLE.** Position cable in vehicle between speedometer head and transfer case. Speedometer head end of cable must be inserted through cowl and grommet fitted around cable at dash.

(2) **CONNECT CABLE TO SPEEDOMETER.** Insert tongue end of shaft into fitting at back of speedometer head and pull shaft casing into place against fitting. Thread knurled nut to speedometer head and tighten snugly.

(3) **CONNECT CABLE TO TRANSFER CASE.** Fit tongue end of shaft into position in transfer case. Pull shaft casing into place against fitting at transfer case and tighten knurled nut.

(4) **INSTALL CABLE CLIPS** Position cable, making sure cable is not bent sharply at any point. Install cable clips, bolts, washers, and

nuts attaching cable to transfer case support, frame side rail, and dash.

138. OIL PRESSURE GAGE.

a. Oil Pressure Gage Removal (fig. 133).

(1) **DISCONNECT OIL TUBE.** Unscrew tubing nut attaching metal oil tube to back of gage. Flexible tube [(GM-2127840) G501-02-76510] need not be disturbed unless necessary to replace.

(2) **REMOVE OIL GAGE.** Remove two nuts and lock washers attaching mounting clamp to gage at back of instrument panel. Remove mounting clamp and press on back of gage [(GM-1506359) G501-01-94071] to remove from driver's side of instrument panel.

b. Oil Pressure Gage Installation (fig. 133).

(1) **INSTALL OIL GAGE.** Position gage in instrument panel. Install mounting clamp on back of gage, then install lock washers and nuts, tightening nuts firmly.

(2) **CONNECT OIL TUBE.** Position flanged end of tubing against fitting on back of gage and attach with tubing nut. Tighten nut carefully to prevent leaks.

139. THERMO GAGE.

a. Thermo Gage Removal (fig. 133).

(1) **DISCONNECT THERMAL UNIT AT ENGINE.** Drain cooling system until coolant is below level of thermal unit, or quickly plug the opening after removal of thermal unit. Unscrew thermal unit from

INSTRUMENTS, GAGES, AND SWITCHES

fitting in engine cylinder head. Loosen and remove bond strap and grommet around capillary tube at dash and push thermal unit through hole into cab.

(2) **REMOVE THERMO GAGE.** Remove two nuts and lock washers, then remove mounting clamp from back of gage. Press on back of gage [(GM-1511254) G508-01-94061] to remove from driver's side of instrument panel. Withdraw capillary tube and thermal unit through opening in instrument panel.

b. Thermo Gage Installation (fig. 133).

(1) **INSTALL THERMO GAGE.** Insert thermal unit and capillary tube through holes in instrument panel and dash, then position gage in instrument panel. Install mounting clamp on back of gage, then install lock washers and nuts.

(2) **INSTALL THERMAL UNIT IN ENGINE.** Screw thermal unit into cylinder head fitting, tightening firmly, then fill cooling system (par. 17). Fit grommet around capillary tube and attach to dash, then attach bond strap to tube.

140. FUEL GAGE.

a. The fuel gage system consists of a gage in the instrument panel and a tank unit in the fuel tank, interconnected electrically. The fuel gage tank unit replacement is described in paragraph 100.

b. Fuel Gage Removal (fig. 133).

(1) **DISCONNECT WIRING.** Remove two nuts and lock washers attaching wiring to terminals at back of gage in instrument panel.

(2) **REMOVE GAGE.** Remove two nuts and lock washers attaching mounting clamp to gage, then remove mounting clamp. Press at back of gage [(GM-1516366) G85-33-01460] to remove from driver's side of instrument panel.

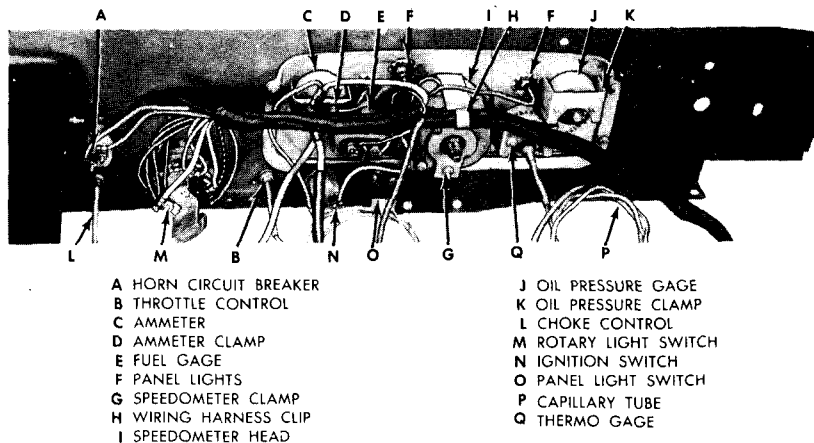

RA PD 333032

**Figure 134—Instrument Panel, Gages, and Switches—
Rear View (Rotary Main Light Switch)**

TRUCK, 2½-TON, 6 x 6

c. Fuel Gage Installation (fig. 133).

(1) **INSTALL GAGE.** Position gage in instrument panel, install mounting clamp on back of gage, then install two lock washers and nuts.

(2) **CONNECT WIRING.** Connect the white wire with red tracer to the terminal marked "IGN" on gage, connect the green wire to the "TANK" terminal on the gage, then install two lock washers and nuts. *NOTE: Caution tag on back of fuel gage-wires must not be reversed or tank unit may be burned out.*

141. AMMETER.

a. Ammeter Removal (fig. 133).

(1) **DISCONNECT WIRING.** Remove two nuts and lock washers attaching wires to ammeter terminals and disconnect wires.

(2) **REMOVE AMMETER.** Remove two nuts and lock washers attaching mounting clamp at back of ammeter, then remove mounting clamp. Press on rear of ammeter [(GM 1500601) (G85-33-00030)] to remove from driver's side of instrument panel.

b. Ammeter Installation (fig. 133).

(1) **INSTALL AMMETER.** Position ammeter in instrument panel. Install mounting clamp over terminals at back of ammeter and install two lock washers and nuts.

(2) **CONNECT WIRING.** Connect wires to ammeter terminals as described in paragraph 136 b (2). Be sure ammeter shows charge with engine running at moderate speed; if not, reverse wiring connections at terminals.

142. IGNITION SWITCH.

a. Ignition Switch Removal (figs. 15, 132, and 134).

(1) **DISCONNECT WIRING.** Remove two screws and lock washers from terminals at back of switch and disconnect wires.

(2) **REMOVE SWITCH.** Unscrew round nut from switch at driver's side of instrument board. Use spanner wrench or punch in the holes in nut to loosen nut. Push on switch from front side of panel to remove from rear side of panel.

b. Ignition Switch Installation (figs. 15, 132, and 134).

(1) **INSTALL SWITCH.** Position switch on instrument board and thread round nut on switch. Tighten round nut firmly, using spanner wrench or punch.

(2) **CONNECT WIRING.** Connect wires to switch terminals with two screws and lock washers.

143. MAIN LIGHT SWITCH.

a. Push-Pull Type Switch (Early Vehicles).

(1) **PUSH-PULL TYPE SWITCH REMOVAL (figs. 15, 132, and 135).**

(a) *Disconnect Wiring.* Remove screws and lock washers attaching wires to switch terminals.

INSTRUMENTS, GAGES, AND SWITCHES

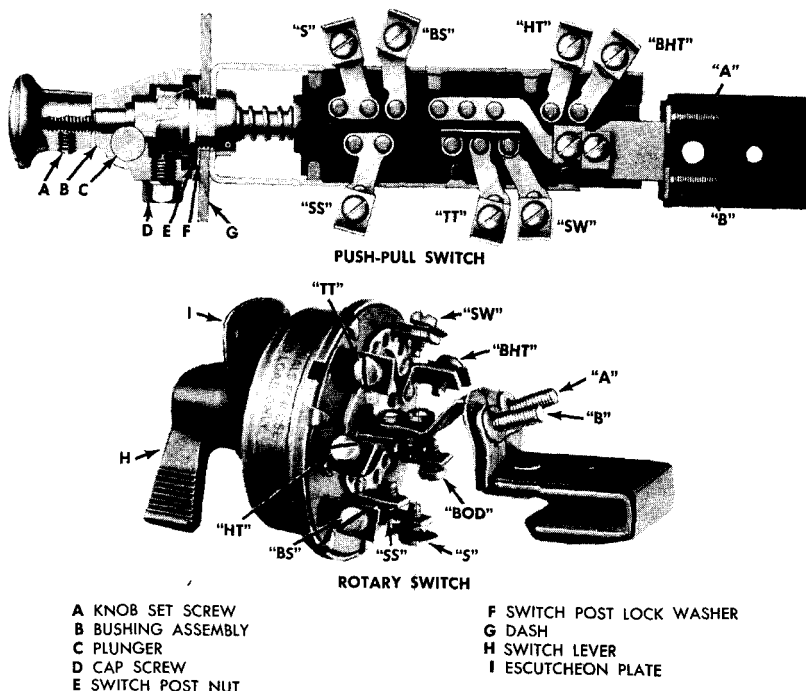

Figure 135—Main Lighting Switches

RA PD 333006

(b) *Remove Switch Knob.* Loosen set screw in knob and unscrew knob.

(c) *Remove Switch Bushing.* Loosen hex head cap screw at side of switch bushing. Press switch locking plunger and pull switch bushing off end of switch.

(d) *Remove Switch.* Remove nut and lock washer from switch at front of instrument board. Push on switch from front side of instrument board to remove.

(2) **PUSH-PULL TYPE SWITCH INSTALLATION** (figs. 15, 132, and 135).

(a) *Connect Wiring to Switch.* Install wires at terminals on switch, and attach with screws and lock washers. Terminal markings are shown in figure 135 and wire connections are as follows:

| Terminal | Circuit | Wire Size and Tracer Color |
|----------|--|----------------------------|
| A | Auxiliary | Not used |
| B | Switch to ammeter | No. 10 yellow |
| BHT | Switch to No. 1 top junction | No. 16 white |
| BS | Switch No. 6 bottom junction | No. 16 black-red tr. |
| HT | Switch to No. 5 top junction | No. 16 black-green tr. |
| | Switch to <i>BAT</i> terminal on dimmer switch | No. 12 black-green tr. |

TRUCK, 2½-TON, 6 x 6

| Terminal | Circuit | Wire size and tracer color |
|----------|---|----------------------------|
| | Switch to instrument panel light switch | No. 16 black-green tr. |
| S | Switch to No. 2 bottom junction | No. 16 red-black tr. |
| SS | Switch to No. 5 bottom junction | No. 16 black-red check |
| TT | Switch to No. 1 bottom junction | No. 16 green-black check |
| SW | Switch to No. 3 bottom junction | No. 16 red |

(b) *Install Switch.* Position switch on instrument board from back of board. Install lock washer and nut on front of switch and tighten nut firmly.

(c) *Install Switch Bushing.* Compress switch locking plunger and position bushing on switch. Press bushing firmly against panel and tighten hex head cap screw so bushing is locked with plunger in upright position.

(d) *Install Switch Knob.* Screw knob onto switch and tighten set screw firmly. Test operation of switch (par. 12).

b. Rotary Type Switch (Late Vehicles).

(1) **ROTARY TYPE SWITCH REMOVAL** (figs. 15, 134, and 135).

(a) *Remove Switch Lever.* Remove screw attaching switch lever to switch and remove lever.

(b) *Remove Switch.* Unscrew nut attaching switch to instrument board, then remove lock washer, flat washer, and escutcheon plate. Push on switch shaft to remove switch from back of panel.

(c) *Disconnect Wiring.* Remove screws and lock washers attaching wires to terminals and remove switch.

(2) **ROTARY TYPE SWITCH INSTALLATION** (figs. 15, 134, and 135).

(a) *Connect Wiring.* Install wires at terminals on switch and attach with screws and lock washers. Terminal markings are shown in figure 135, and wire connections are as follows:

| Terminal | Circuit | Wire Size and Tracer Color |
|----------|--|----------------------------|
| A | Auxiliary | Not used |
| B | Switch to ammeter | No. 10 yellow |
| BHT | Switch to No. 1 top junction | No. 16 white |
| BOD | Switch to No. 3 post junction | No. 16 white-black tr. |
| BS | Switch to No. 6 bottom junction | No. 16 black-red check |
| HT | Switch to No. 5 top junction | No. 16 black-green tr. |
| | Switch to <i>BAT</i> terminal on dimmer switch | No. 12 black-green tr. |
| | Switch to instrument panel light switch | No. 16 black-green tr. |
| S | Switch to No. 2 bottom junction | No. 16 red-black tr. |
| SS | Switch to No. 5 bottom junction | No. 16 red-black check |
| SW | Switch to No. 3 bottom junction | No. 16 red |
| TT | Switch to No. 1 bottom junction | No. 16 green-black check |

(b) *Install Switch.* Position switch in instrument board, install escutcheon plate, lock washer, flat washer, and nut, then tighten nut firmly.

(c) *Install Switch Lever.* Position switch lever on switch shaft and attach with screw, tightening screw firmly.

INSTRUMENTS, GAGES, AND SWITCHES

144. BLACKOUT DRIVING LIGHT SWITCH.

a. Blackout driving light switch is used only with push-pull type main light switch. Connections for blackout driving light are incorporated in rotary light switch, hence necessity for separate driving light switch is eliminated on late vehicles with rotary type main light switch.

b. **Blackout Driving Light Switch Removal** (figs. 15 and 132).

(1) **REMOVE SWITCH KNOB.** Loosen set screw in knob, then unscrew knob from switch.

(2) **REMOVE SWITCH.** Remove nut and lock washer attaching switch to instrument board. Press on switch at driver's side of instrument board to remove from board.

(3) **DISCONNECT WIRING.** Remove two screws and lock washers attaching wires to switch and remove switch.

c. **Blackout Driving Light Switch Installation** (figs. 15 and 132).

(1) **CONNECT WIRING.** Attach wires to switch with two screws and lock washers, tightening screws firmly.

(2) **INSTALL SWITCH.** Position switch in instrument board from back of board. Install lock washer and nut on switch, tightening nut firmly.

(3) **INSTALL SWITCH KNOB.** Screw knob onto switch and tighten set screw firmly.

145. PANEL LIGHTS AND SWITCH.

a. Instrument panel gages and switches are illuminated by three lights, mounted on the instrument panel and controlled by a switch mounted on the instrument board.

b. **Panel Lamp and Socket Removal** (figs. 15, 132, 133, and 134).

(1) **REMOVE SHIELD, SOCKET, AND LAMP ASSEMBLY.** Pry shield, socket, and lamp assembly out of instrument panel from front side, using screw driver.

(2) **REMOVE LAMP AND SOCKET UNIT FROM SHIELD.** Grip shield firmly in one hand and pull on wire with other hand to pull lamp and socket out of shield.

(3) **REMOVE LAMP FROM SOCKET.** Grip socket assembly in one hand and press on lamp, turning to left to free from socket. Remove lamp from socket with fingers. Socket remains attached to wiring harness.

c. **Panel Lamp and Socket Installation** (figs. 15, 132, 133, and 134).

(1) **INSTALL LAMP IN SOCKET.** Fit lamp into socket, press down, and turn to right to install in socket.

(2) **INSTALL LAMP AND SOCKET UNIT IN SHIELD.** Insert lamp and socket unit through hole in instrument panel from rear side. Press socket into shield until it seats firmly.

TRUCK, 2 1/2 -TON, 6 x 6

(3) **INSTALL SHIELD, SOCKET, AND LAMP ASSEMBLY.** Position shield, socket, and lamp assembly at hole in instrument panel and press until shield snaps into place.

d. Instrument Light Switch Removal (figs. 15, 132, and 134).

(1) **REMOVE SWITCH KNOB.** Loosen set screw in switch knob and unscrew knob from switch.

(2) **REMOVE SWITCH.** Remove nut and lock washer attaching switch to instrument board. Remove switch from back of instrument board.

(3) **DISCONNECT WIRING.** Remove two screws and lock washers attaching wires to switch.

e. Instrument Light Switch Installation (figs. 15, 132, and 134).

(1) **CONNECT WIRING.** Attach wires to switch with two screws and lock washers, tightening screws firmly.

(2) **INSTALL SWITCH.** Position switch in instrument board. Install nut and lock washers, tightening nut firmly.

(3) **INSTALL SWITCH KNOB.** Screw knob onto switch and tighten set screw firmly.

146. HORN AND BUTTON.

a. General. The electric vibrating type horn is mounted on the intake manifold and is controlled by a button mounted in the hub of the steering wheel. Current for operation of the horn is supplied by the battery; the horn circuit is protected by an automatic type circuit breaker mounted on the back of the instrument board.

b. Horn Removal.

(1) **DISCONNECT WIRING.** Remove screws and lock washers attaching wires to horn terminals, then disconnect wires from horn.

(2) **REMOVE HORN.** Remove two nuts, lock washers, and bolts attaching horn to intake manifold and remove horn.

c. Horn Installation.

(1) **INSTALL HORN.** Position horn and bracket on intake manifold and attach with two bolts, nuts, and lock washers.

(2) **CONNECT WIRES.** Attach wires to horn terminals with washers and screws, tightening screws firmly.

d. Horn Button Removal. Remove two screws attaching horn button retainer to steering wheel, then remove retainer, horn button, contact, insulator, and spring.

e. Horn Button Installation. Position spring, insulator, contact, horn button, and retainer on steering wheel, and install two retainer screws.

f. Horn Circuit Breaker Removal (figs. 132 and 134).

(1) **REMOVE CIRCUIT BREAKER FROM INSTRUMENT BOARD.** Remove two screws, nuts, and lock washers attaching circuit breaker to back of instrument board.

(2) **DISCONNECT WIRING.** Remove two screws and lock washers attaching wires to circuit breaker, and remove circuit breaker.

INSTRUMENTS, GAGES, AND SWITCHES

g. Horn Circuit Breaker Installation (figs. 132 and 134).

(1) **CONNECT WIRING.** Attach wires to circuit breaker with two screws and lock washers, tightening screws firmly.

(2) **INSTALL CIRCUIT BREAKER.** Position circuit breaker on back of instrument board and install two attaching screws, nuts, and lock washers.

147. DIMMER SWITCH.

a. Dimmer switch is located on the toe board riser to the left of the clutch pedal and is operated by the left foot to select the upper and lower headlight beam.

b. Dimmer Switch Removal.

(1) **REMOVE SWITCH.** Remove two screws and lock washers attaching switch to toe board support and withdraw switch.

(2) **DISCONNECT WIRING.** Remove three screws and lock washers attaching wires to switch terminals, and remove switch (GM-1997014).

c. Dimmer Switch Installation.

(1) **CONNECT WIRING.** Attach wires to switch with three screws and lock washers. The No. 12 black wire with green tracer must be attached to the "BATT" terminal; connect the other wires to the remaining terminals.

(2) **INSTALL SWITCH.** Position switch in hole in toe board support and attach with two screws and lock washers, tightening screws firmly.

148. STOP LIGHT SWITCH.

a. Stop light switch, located at the outlet end of the brake master cylinder, is operated by the hydraulic pressure in the master cylinder. Before replacing switch, connect the wires together and if stop lights are not illuminated, the cause is elsewhere than in the stop light switch.

b. Stop Light Switch Removal.

(1) **DISCONNECT WIRING.** Pull wires off snap terminals on switch.

(2) **CAUTION:** New switch should be installed immediately after removal of switch to prevent loss of brake fluid. *Do not apply brakes while switch is removed*, as brake fluid would be lost through opening; also it would be necessary to bleed the entire brake system if air were admitted into the system.

(3) **REMOVE SWITCH.** From under vehicle, unscrew switch (GM-1320938) from master cylinder outlet fitting.

c. Stop Light Switch Installation.

(1) **INSTALL SWITCH.** Thread switch into outlet fitting on brake master cylinder and tighten firmly.

(2) **CONNECT WIRING.** Attach a wire to each of the two terminals on the switch. Wires can be attached to either terminal.

TRUCK, 2½-TON, 6 x 6

Section XXVI

CLUTCH AND CONTROLS

149. DESCRIPTION.

a. The clutch consists of two separate assemblies—the clutch disc assembly and the clutch cover and pressure plate assembly. The driven disc transfers engine power from the flywheel to the transmission main drive gear shaft. The clutch cover and pressure plate provide attachment or release of the driven disc to the flywheel. The clutch is always in “engaged” position unless purposely “disengaged” by the driver.

150. CLUTCH PEDAL FREE-TRAVEL ADJUSTMENT.

a. Clutch pedal free-travel is the movement of the pedal before the clutch starts to disengage. Pedal free-travel must be 2½ inches with new facings. As the facings wear, adjusting nuts on the adjusting link should be backed off to maintain a 2½-inch free-travel until the lock nut is at the end of the thread; then clutch may be operated until free-travel is reduced to 1 inch at which time clutch driven member assembly (with new facings) must be replaced.

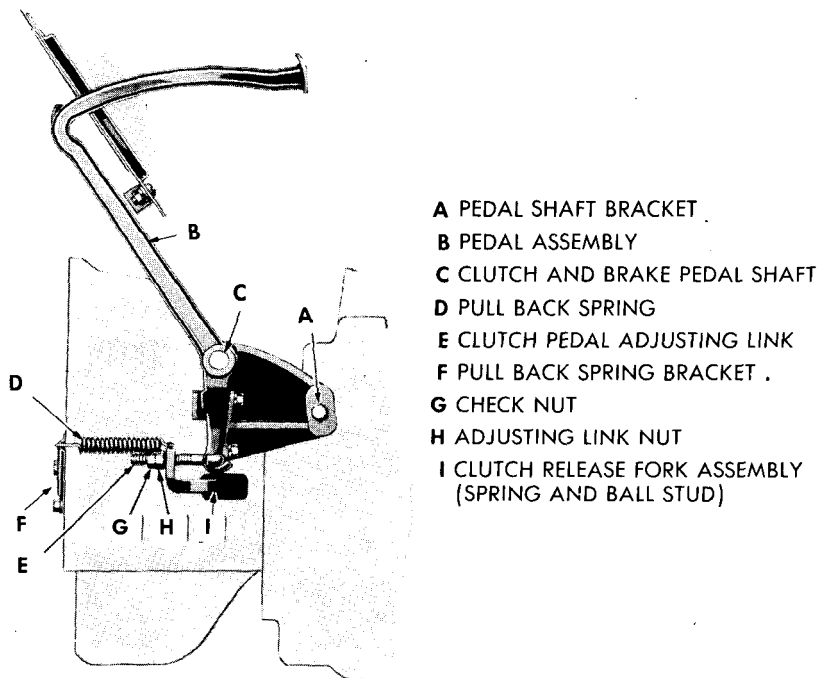

- A PEDAL SHAFT BRACKET
- B PEDAL ASSEMBLY
- C CLUTCH AND BRAKE PEDAL SHAFT
- D PULL BACK SPRING
- E CLUTCH PEDAL ADJUSTING LINK
- F PULL BACK SPRING BRACKET
- G CHECK NUT
- H ADJUSTING LINK NUT
- I CLUTCH RELEASE FORK ASSEMBLY (SPRING AND BALL STUD)

Figure 136—Pedal Linkage

RA PD 64626

CLUTCH AND CONTROLS

b. Pedal Free-travel Adjustment.

(1) **CHECK PEDAL FREE-TRAVEL.** Pedal free-travel must be checked with hand on the pedal and not with foot, as this check is very sensitive. If free-travel of clutch is less than 2½ inches, and lock nut has not already been adjusted to the end of the adjusting link threads, adjust pedal.

(2) **ADJUST PEDAL** (fig. 136). Loosen check nut on adjusting link, and turn adjusting nut in or out as may be required to obtain proper free-travel of foot pedal. With pedal free-travel definitely established, turn up check nut firmly against adjusting nut to prevent adjustment from coming loose, then recheck pedal free-travel. After limit of adjustment is reached, any free-travel in excess of 1 inch is satisfactory.

151. CLUTCH PEDAL AND LINKAGE.

a. **Description.** Clutch pedal is connected to the release fork through the linkage (fig. 136). Release fork is mounted in the clutch housing by a ball stud and support. Inner end of the fork engages a groove in the release bearing support for actuation of the release bearings.

b. **Clutch Pedal and Linkage Removal** (fig. 136). Remove attaching screws from toe board assembly and remove toe board to gain access to pedal and linkage. Disconnect pedal pull back spring [(GM-368244) G85-11-02090]. Loosen and remove check nut and adjusting nut, then remove adjusting link. With suitable drift, drive out pin at outer end of pedal shaft and remove collar and pedal assembly.

c. **Clutch Pedal and Linkage Installation** (fig. 136). Place clutch pedal over end of pedal shaft. Install collar on outer end of shaft, aline hole in collar with hole in shaft, then drive in new retaining pin. Connect adjusting link to clutch pedal with threaded end through hole in fork, then install adjusting nut and check nut, and connect pedal pull back spring. Install toe board assembly, and tighten attaching screws firmly. After toe board assembly has been installed, adjust clutch pedal free-travel (par. 150 b).

152. CLUTCH REPLACEMENT.

a. Removal.

(1) **REMOVE TRANSMISSION.** Remove transmission assembly (par. 154). Clutch release bearing assembly is then accessible.

(2) **REMOVE RELEASE FORK AND BALL STUD ASSEMBLY.** Disconnect pedal pull back spring. Loosen and remove check nut and adjusting nut, then remove adjusting link. With a ¾-inch offset open end wrench, hold ball stud support from inner side of clutch housing, then remove ball stud support from outer side of clutch housing. Release fork with ball stud can then be removed.

(3) **REMOVE CLUTCH.** The clutch units include clutch pressure plate assembly (includes cover, pressure plate, springs, etc.) and

TRUCK, 2½-TON, 6 x 6

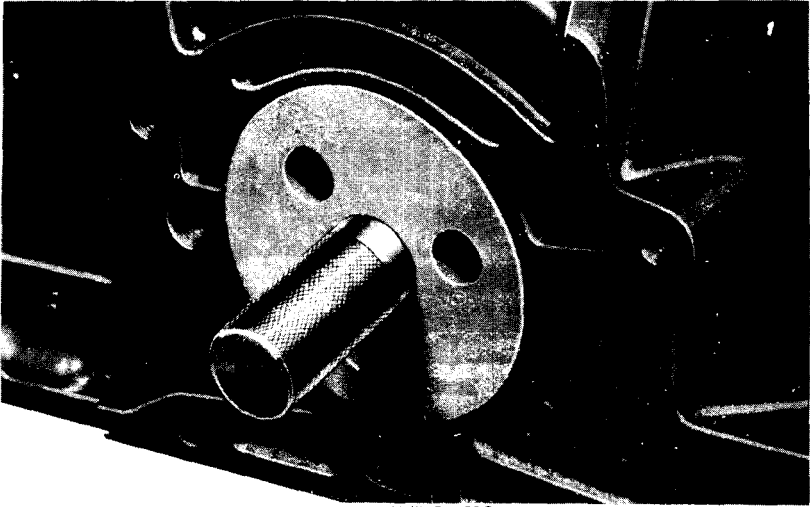

ALINING ARBOR

RA PD 332968

Figure 137—Use of Clutch Alining Arbor (41-A-335)

clutch driven member assembly (includes facing, torsion springs, etc.). Insert clutch alining arbor (41-A-335) (fig. 137) through clutch assembly and driven disc hub. Loosen the nine clutch cover to fly-wheel cap screws one turn at a time until diaphragm spring pressure is fully released; then completely remove all cap screws and withdraw alining arbor and lower clutch pressure plate assembly and clutch driven member assembly.

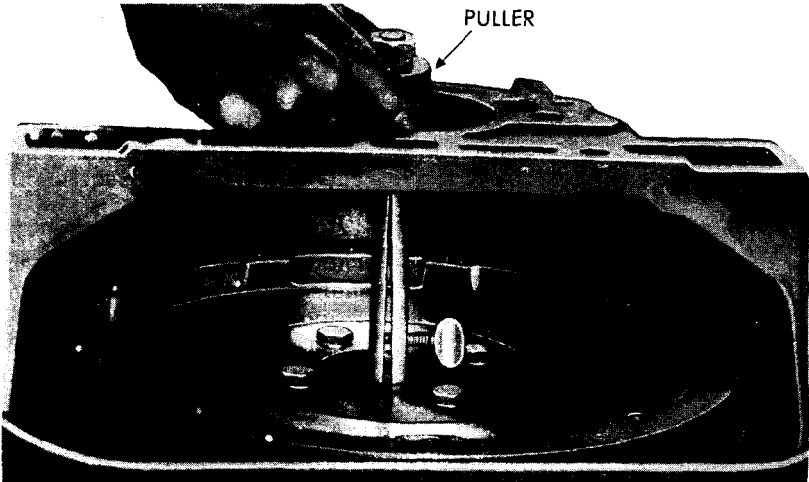

RA PD 332920

Figure 138—Removing Pilot Bearing (Puller 41-P-2906-15)

CLUTCH AND CONTROLS



Figure 139—Removing or Installing Clutch Assembly RA PD 303118

(4) REMOVE CLUTCH PILOT BEARING. Insert puller (41-P-2906-15) (fig. 138) in recess of crankshaft and remove bearing. Pilot bearing is shielded type and requires attention only when clutch is removed from vehicle. If damaged or broken, replace.

b. Installation.

(1) INSTALL CLUTCH PILOT BEARING. Before bearing is installed it must be lubricated as described in Section VIII. Using alining arbor (41-A-335) with three $\frac{5}{8}$ -inch washers, install pilot bearing. Care must be exercised to provide exact bearing alignment with pilot hole in flywheel housing. Install shielded side of bearing toward transmission.

(2) ATTACH CLUTCH ASSEMBLIES TO FLYWHEEL. Hand crank engine until "X" mark on flywheel is visible from underside of clutch housing. Place driven member assembly and clutch pressure plate assembly against flywheel and rotate cover until "X" mark on cover (fig. 139) aligns with "X" mark on flywheel. Insert clutch alining arbor (41-A-335) in clutch assembly and driven disc (fig. 137), then install cap screws which attach cover to flywheel. Each cap screw should be tightened gradually, a turn at a time, to prevent distortion of cover as spring pressure is taken up. Withdraw alining arbor.

(3) CLEAN, LUBRICATE, AND INSTALL BALL STUD. Lift ball stud retainer spring out of fork and withdraw ball stud. Pack ball seat in fork, lubricating as specified in Section VIII, and install ball stud and

TRUCK, 2½-TON, 6 x 6

retainer spring. Be sure to place ends of ball retainer spring downward so that spring will be completely seated in grooves in fork.

(4) **INSTALL CLUTCH RELEASE FORK AND LINKAGE.** Install fork and ball stud assembly, using care to see that fingers at inner end of fork are in groove of release bearing sleeve, then thread support into ball stud. Make sure ball stud and support are drawn up tightly. Attach adjusting link to clutch pedal and through fork arm, then install adjusting nut, check nut, and pull back spring.

(5) **INSTALL TRANSMISSION AND ADJUST PEDAL.** Install release bearing assembly and transmission assembly (par. 155), adjust clutch pedal free-travel (par. 150 b).

Section XXVII

TRANSMISSION

153. DESCRIPTION.

a. The transmission is a selective sliding gear type and provides for five speeds forward and one reverse. Fourth speed is direct, with fifth speed overdrive. Gears are selected manually by a conventional gearshift lever. The transmission assembly is bolted directly to the clutch housing. The power plant and transmission assembly is stabilized by a strut rod which is connected between the rear of the transmission and the transfer case crossmember. On models equipped with a winch or power hoist, a power take-off is attached to the left-hand side of the transmission. All vehicles have a transfer case high and low speed control cross shaft, mounted at the rear of transmission case.

154. REMOVAL.

a. **Preliminary Instructions.** Vehicles equipped with winch or power hoist have a power take-off installed on the left-hand side of the transmission. The following procedure covers removal of transmission either with or without power take-off, with differences noted in text. Key letters in text refer to figure 140. **NOTE:** *Transfer case high and low speed control rods, levers, and cross shaft are slightly different on vehicles equipped with banjo type axles than those on vehicles having split type axles (fig. 140); however, removal and installation procedure are the same.*

b. **Drain Lubricant.** Remove drain plug from lower rear side of transmission and allow lubricant to drain. Install plug after draining.

c. **Remove Floor Pan.** Place transfer case control levers in neutral and pull hand brake lever to rear. Lift seal off over levers. Remove 12 floor pan cap screws and lock washers and lift floor pan up over levers and out of cab.

TRANSMISSION

d. Remove Hand Brake Lever and Bracket. Release hand brake and remove cotter pin and clevis pin attaching hand brake rod (C) to lever. Remove two cap screws and washers (A) attaching hand brake bracket to right-hand side of transmission cover and lift

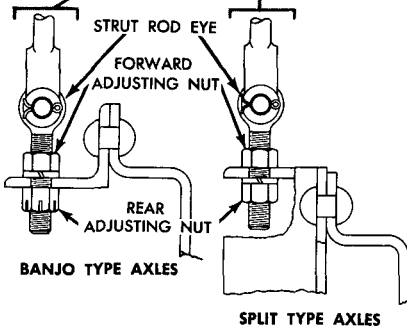
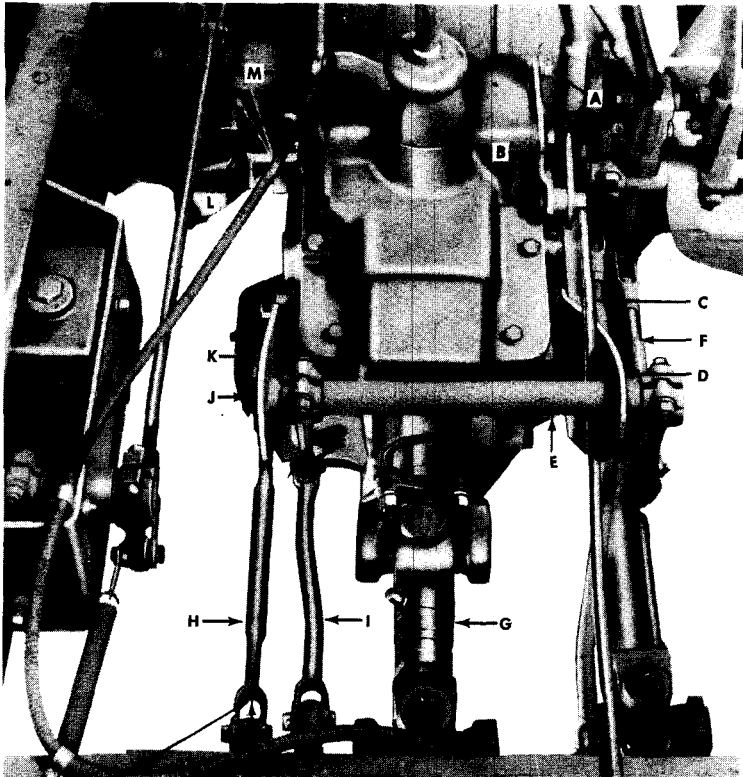

- A CAP SCREWS
- B HAND BRAKE LEVER AND BRACKET
- C HAND BRAKE ROD
- D RIGHT-HAND CROSS SHAFT BRACKET
- E CROSS SHAFT
- F HIGH AND LOW CONTROL ROD-FRONT
- G PROPELLER SHAFT
- H TRANSMISSION STRUT ROD
- I HIGH AND LOW CONTROL ROD-REAR
- J RETAINER SPRING
- K LEFT-HAND CROSS SHAFT BRACKET
- L PEDAL SHAFT BRACKET
- M CAP SCREW

Figure 140—Transmission Assembly Installed (Split Type Axles Without Power Take-Off Shown)

RA PD 333028

TRUCK, 2 1/2-TON, 6 x 6

hand brake lever and bracket assembly (B) out of cab. Remove cap screw and lock washer (M) attaching speedometer cable clip to left-hand side of cover.

e. **Remove High and Low Control Lever Cross Shaft and Brackets.** Remove cotter pins and clevis pins attaching high and low control rods (F and I) to cross shaft levers. Pull retainer spring (J) from left end of cross shaft. Loosen rear nut on transmission strut rod eye (fig. 140). Remove cotter pin and clevis pin attaching strut rod (H) to left-hand cross shaft bracket (K). On vehicles without power take-off, remove two nuts and lock washers from studs attaching left-hand cross shaft bracket (K) to transmission and pull bracket off end of studs and cross shaft (E). On vehicles with power take-off, remove power take-off control lever or levers from stud in side of transmission (par. 157 or 158). Remove control lever stud, remove nut and lock washer from forward stud, and remove bracket. Remove two nuts and lock washers from studs attaching right-hand bracket (D) to transmission and remove bracket and cross shaft (E) assembly.

f. **Disconnect Propeller Shaft.** Remove four nuts, lock washers, and bolts attaching propeller shaft universal joint (G) to main drive gear companion flange. Swing shaft up and to one side and fasten with a piece of wire. Disconnect power take-off drive shaft or shafts at power take-off if used (par. 240 or 245).

g. **Remove Pedal Shaft Bracket to Transmission Cap Screw.** Remove cap screw and lock washer attaching pedal shaft bracket (L) to transmission. Loosen, but do not remove, two cap screws attaching pedal shaft bracket to clutch housing.

h. **Remove Flywheel Underpan.** Remove four cap screws attaching flywheel underpan to clutch housing and remove underpan.

i. **Remove Transmission.** Remove lock wire from two transmission to clutch housing lower cap screw heads and remove cap screws from inside clutch housing. Support transmission on a dolly jack or support from above with a hoist and chains. Remove two transmission to clutch housing upper cap screws and lock washers. With the assembly securely supported, move assembly back until main drive gear shaft clears opening in clutch housing. **CAUTION: Do not allow weight of transmission to rest on clutch disc hub and do not permit clutch release bearing and support assembly to drop from release fork.** Lower assembly and tip to one side to permit gearshift lever to clear under side of chassis and withdraw from under vehicle. Do not move clutch pedal while transmission is removed.

155. INSTALLATION.

a. **Preliminary Instructions.** The following procedure covers installation of transmission either with or without power take-off, with differences noted in text. Transfer case high and low speed control rods, levers, and cross shaft are slightly different on vehicles equipped with banjo type axles than on vehicles equipped with split

TRANSMISSION

type axles (fig. 140); however, installation procedures for both types are the same. Key letters in text refer to figure 140.

b. Install Transmission. Slide transmission under vehicle and guide gearshift lever up through floor pan opening in cab. Support transmission on a dolly jack or support from above with a hoist and chains. Make sure clutch release bearing and support assembly is in place in clutch release fork. Raise assembly until main drive gear shaft will enter release bearing and clutch disc hub and move forward against clutch housing. **CAUTION: Do not allow weight of transmission to rest on clutch disc hub.** If main drive gear splines do not mesh with splines in clutch disc hub, place transmission gearshift lever in 5th speed position and turn main drive gear shaft at rear of transmission with hand to aline splines. Install two transmission to clutch housing upper cap screws and lock washers, and inside clutch housing install two transmission to clutch housing lower cap screws. Tighten all four cap screws firmly and thread lock wire through holes in heads of lower cap screws. Twist ends of lock wire together. Remove jack from under vehicle, or remove chains as the case may be.

c. Install Flywheel Underpan. Position flywheel underpan against under side of clutch housing and attach with four cap screws and internal toothed lock washers. Frame to clutch housing bond strap must be installed under head of underpan to clutch housing left front cap screw.

d. Install Pedal Shaft Bracket to Transmission Cap Screw. Install pedal shaft bracket (L) to transmission cap screw, using lock washer. Tighten cap screw firmly, then tighten two pedal shaft bracket to clutch housing cap screws.

e. Install High and Low Control Cross Shaft and Brackets. Position right-hand bracket and cross shaft assembly (D and E) with holes in bracket over two studs in right-hand side of transmission. Install nuts and lock washers on studs and tighten firmly. On vehicle without power take-off (fig. 140), place left-hand bracket (K) over studs in left-hand side of transmission and over end of cross shaft (E). Install nuts and lock washers and tighten firmly. On vehicles with power take-off, the procedure is the same except that the rear stud is replaced with a special stud on which power take-off control lever or levers pivot. Install retainer spring (J) in groove in left end of cross shaft (E). Connect transfer case high and low control rods (F and I) to cross shaft levers, using clevis pins and new cotter pins. Adjust high and low speed control linkage (par. 160). On vehicles equipped with power take-off, install power take-off control lever or levers (par. 157 or 158).

f. Connect and Adjust Transmission Strut Rod (fig. 140). Connect forward end of strut rod (H) to left-hand cross shaft bracket, using clevis pin and new cotter pin. Adjust rod as follows:

(1) **WITH BANJO TYPE AXLES,** Run forward adjusting nut toward front of eye rod. Turn rear adjusting nut onto eye rod until nut fully contacts bracket, then tighten rear nut one full turn. Run forward adjusting nut back against bracket and tighten firmly.

TRUCK, 2 1/2-TON, 6 x 6

(2) **WITH SPLIT TYPE AXLES.** Run rear adjusting nut toward rear end of eye rod. Run forward adjusting nut back until nut fully contacts bracket, then turn forward nut one full turn toward front end of eye rod. Tighten rear adjusting nut firmly against bracket.

g. Install Hand Brake Lever and Bracket. Position hand brake lever and bracket assembly (B) on right-hand side of transmission cover and install two cap screws (A) with lock washer under head of rear cap screw, and ground strap, flat washer, and lock washer under head of forward cap screw. Tighten cap screws firmly. Adjust and connect hand brake rod (C) to hand brake lever (par. 193). Attach speedometer cable clip to left-hand side of cover, using cap screw and lock washer.

h. Prepare Transmission for Service. Lubricate transmission with type and quantity of lubricant as directed in Section VIII. Tighten filler and drain plugs firmly. Start engine and run transmission three or four minutes with shift lever in each position. This will definitely work lubricant into close clearances.

i. Connect Propeller Shaft. Attach propeller shaft universal joint (G) to main drive gear companion flange, using four bolts, nuts, and lock washers. Tighten nuts firmly. Connect power take-off drive shaft or shafts at power take-off if used (par. 240 or 245).

j. Install Floor Pan. Install floor pan over control levers in cab and attach with 12 cap screws and lock washers. Place transfer case control levers in neutral position, pull hand brake back, and install floor seal over ends of levers.

Section XXVIII

POWER TAKE-OFF AND CONTROLS

156. DESCRIPTION.

a. General. Power take-off assembly, mounted on left-hand side of transmission, provides two forward speeds and one reverse speed for winch operation, and one speed for operation of power hoist. Power take-off intermediate gear is constantly meshed with the transmission reverse idler gear, making it possible to use power take-off at any time the vehicle engine is operating. Power is transferred to auxiliary units through drive shafts which connect directly with power take-off output shaft. Control levers which are connected with shift shaft at power take-off are located in cab and are shifted manually. Difference in design of dual and single drive power take-off assemblies are covered in succeeding paragraphs 157 and 158. Lubricant in transmission case also lubricates power take-off assembly.

POWER TAKE-OFF AND CONTROLS

b. **Data.** Two makes of single drive power take-off assemblies are used on early vehicles, both of which are similar in construction, and can be identified by referring to name plate.

- (1) **SINGLE DRIVE (Early Vehicles).**

| | | |
|--------|-----------------------|--------------|
| Type | Two-speed and reverse | |
| Make | Heil | Gar Wood |
| Models | B-360 | 67-Y-60000LG |
| Drive | Transmission | Transmission |
- (2) **SINGLE DRIVE (Late Vehicles).**

| | | |
|-------------|-----------------------|--|
| Type | Two-speed and reverse | |
| Make | GMC | |
| GM Part No. | 2200208 | |
| Drive | Transmission | |
- (3) **DUAL DRIVE.**

| | | |
|--------------------|-----------------------|--|
| Type (winch drive) | Two-speed and reverse | |
| Type (hoist drive) | One-speed | |
| Make | GMC | |
| Drive | Transmission | |

157. SINGLE DRIVE POWER TAKE-OFF AND CONTROLS.

a. **General.** Winch-equipped vehicles have a single drive power take-off, mounted on left-hand side of transmission. Backlash between transmission gear and power take-off intermediate gear is controlled by adding or removing gasket between the two assemblies. Single drive assembly used on late vehicles can be converted to a dual type by replacing the auxiliary drive shaft cover with an auxilli-

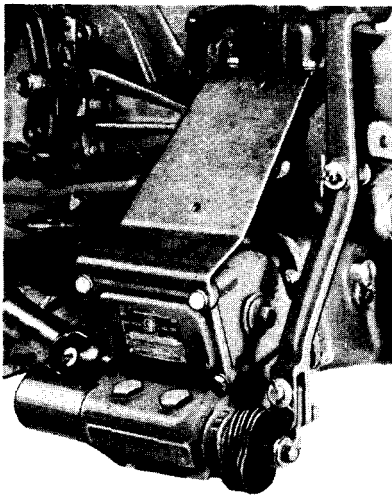

SINGLE DRIVE P.T.O. (EARLY TYPE)

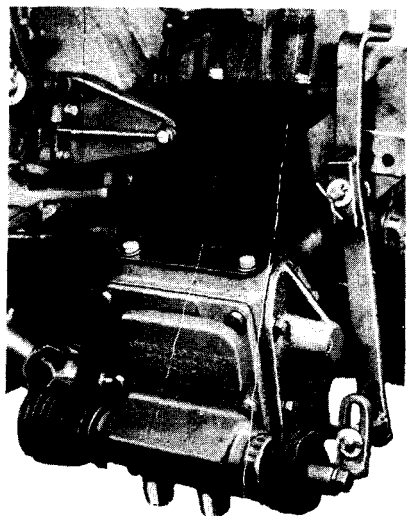

SINGLE DRIVE P.T.O. (LATE TYPE)

Figure 141—Single Drive Power Take-Off Installation

RA PD 332990

TRUCK, 2½-TON, 6 x 6

ary drive assembly. Controls for single drive power take-off consists simply of a lever which pivots on a special stud at transmission case and is connected directly with shift shaft arm on power take-off assembly. Control lever lock, attached to cab floor pan, prevents accidental engagement of power take-off which might cause serious damage to winch mechanism (fig. 33).

b. Power Take-off Removal. Removal instructions which follow apply to both the early and the late type assemblies (fig. 141), except as otherwise stated in the text. This operation is necessary when a transmission is being replaced by consent of higher authority.

(1) **DRAIN LUBRICANT.** Remove drain plug from power take-off gear case, remove transmission filler plug and allow all lubricant to drain into suitable receptacle. **NOTE:** *If assembly is not equipped with drain plug, as is the case on some early assemblies, it will be necessary to remove transmission drain plug.*

(2) **REMOVE POWER TAKE-OFF TO TRANSMISSION BRACE** (fig. 141). Remove floor pan retaining screws; then raise floor pan sufficiently to permit access to upper end of brace. Remove two brace to transmission cap screws and two brace to power take-off cap screws, then remove brace.

(3) **DISCONNECT WINCH DRIVE SHAFT.** Loosen set screw and move drive shaft stop collar forward. Loosen set screw in drive shaft rear U-joint yoke; then drive yoke off power take-off shaft. **NOTE:** *Thread wire through U-joint and suspend winch drive shaft from chassis to prevent slip joint from coming apart.*

(4) **DISCONNECT CONTROL LEVER (Early Type).** Disconnect control lever from shift shaft by removing lever to arm pin and two flat washers.

(5) **DISCONNECT CONTROL LEVER (Late Type).** Move control lever forward as far as possible. Loosen arm to shift shaft screw, withdraw cotter pin and remove flat washer from lower end of lever. Turn shift shaft arm away from lever, thus disengaging arm and lever. Remove washer from lower end of lever.

(6) **REMOVE ASSEMBLY FROM VEHICLE.** Remove six stud nuts, lock washers, and flat washers which mount assembly to transmission. Use pry bar to spring exhaust pipe away from assembly to permit removal from stud bolts. Pull assembly away from transmission until free from stud bolts and remove from vehicle. Remove gaskets, and place cloth or paper covering over opening in transmission case to prevent entrance of dirt or foreign material while assembly is removed.

c. Power Take-off Installation. Installation instructions which follow apply to both the early and the late type assemblies unless otherwise stated in the text.

(1) **ATTACH ASSEMBLY TO TRANSMISSION.** Coat three gaskets, on both sides, with aviation type cement. Place gaskets on studs at transmission case; then place the power take-off in position at transmission case and install one flat washer, one lock washer, and a nut on each stud. Tighten nuts in successive stages until firm.

POWER TAKE-OFF AND CONTROLS

(2) **CHECK OPERATION.** There should be a small amount of backlash between power take-off gear and reverse idler gear (approximately 0.005—0.008 in.) in transmission. This backlash can be checked by grasping output shaft and turning, with power take-off in gear. If backlash is excessive (noise) remove one gasket between power take-off and transmission case. If movement is not sufficient (tight), add one gasket.

(3) **INSTALL POWER TAKE-OFF TO TRANSMISSION BRACE.** Position brace, then install two cap screws with lock washers at each end of brace. When cap screws have been firmly tightened drop floor pan into place and install retaining screws.

(4) **CONNECT WINCH DRIVE SHAFT TO POWER TAKE-OFF SHAFT.** Be certain that key is in position in power take-off shaft. With keyway in U-joint yoke aligned with key, push yoke onto power take-off shaft. Tighten set screw in U-joint yoke and position stop collar (par. 240).

(5) **CONNECT CONTROL LEVER (Early Type).** Position lower end of control lever astride shifter shaft arm and install pin with one retaining washer at each side of control lever. Secure with new cotter pin. Make sure that shifter shaft arm retaining screw is tight.

(6) **CONNECT CONTROL LEVER (Late Type).** With arm to shift shaft cap screw loosened to allow arm to be turned, place flat washer on lower end of lever, turn arm and move lever as necessary to engage elongated hole in arm with lower end of lever. Place flat washer on lever and against shift shaft arm, install cotter pin in lever, then tighten arm to shift shaft screw firmly.

(7) **INSTALL LUBRICANT.** With drain plugs securely tightened in power take-off and transmission, add lubricant (Section VIII) through transmission filler plug hole until lubricant level is up to filler plug hole. Install filler plug.

d. Winch Power Take-off Control Lever Removal (fig. 141).

(1) **REMOVE FLOOR PAN.** Remove transfer case control lever seal, remove floor pan retaining screws, then remove floor pan.

(2) **REMOVE WINCH POWER TAKE-OFF CONTROL LEVER (Early Vehicles) (fig. 141).** Remove cotter pin, clevis pin, and flat washers at lower end of control lever. Remove cotter pin and flat washer from stud at transmission, then remove control lever from vehicle. Remove special stud and lock washer from transmission. If necessary to remove arm from power take-off shift shaft, it is only necessary to remove cap screw and washers from end of shift shaft and withdraw arm.

(3) **REMOVE WINCH POWER TAKE-OFF CONTROL LEVER (Late Vehicles) (fig. 141).** Loosen cap screw which attaches arm to power take-off shift shaft. Remove cotter pin and flat washer from lower end of lever, then turn arm and move lever as necessary to disengage arm from lever. Remove flat washer from lower end of control lever. Remove cotter pin and flat washer from stud at transmission and remove control lever from stud. Remove special stud and lock washer from transmission case.

TRUCK, 2 1/2-TON, 6 x 6

e. Winch Power Take-off Control Lever Installation.

(1) **INSTALL CONTROL LEVER (Early Vehicles)** (fig. 141). Install and tighten special stud at transmission case, using lock washer between stud and transfer case cross shaft bracket. If shift shaft arm has been removed, place arm on shift shaft with boot clamp washer between arm and boot, then install arm to shaft cap screw finger-tight. Be certain that retainer washer and lock washer are in place under cap screw head. Place control lever on stud at transmission and install flat washer and cotter pin. Place lower end of control lever astride shift shaft arm and install clevis pin through lever and arm, with one flat washer at each side of lever. Secure pin, using new cotter pin, and tighten arm retaining cap screw in end of shift shaft.

(2) **INSTALL CONTROL LEVER (Late Vehicles)** (fig. 141). Install and tighten special stud at transmission, using lock washer between stud and transfer case cross shaft bracket. Place control lever on stud, then install flat washer and cotter pin. Loosen arm to shift shaft screw sufficiently to allow arm to be turned. Place flat washer on lower end of lever and turn arm and move lever as necessary to engage elongated hole in arm with lower end of lever. Install flat washer and cotter pin at lower end of lever, then tighten arm to shift shaft screw firmly.

(3) **INSTALL FLOOR PAN.** Guide floor pan over control levers and into position in cab, then install retaining screws. Install transfer case control lever seal. Lock lever in neutral position.

158. DUAL DRIVE POWER TAKE-OFF AND CONTROLS.

a. General. Dual drive power take-off is installed on CCKW-353 (long wheelbase vehicles) equipped with winch and dump body power hoist. The assembly is mounted on transmission in same manner as single drive assembly (par. 157). Two types of controls and linkage are used in shifting the dual drive power take-off. Hoist controls and linkage used on vehicles prior to chassis serial No. 398030 (fig. 142) consists of two levers which pivot on a cross shaft mounted on brackets which are bolted to transfer case support. The hoist power take-off control lever is interconnected with auxiliary shift rod at power take-off by a short rod. The hoist pump control lever is connected with the hoist pump through rods and must be removed from vehicle whenever power take-off linkage is removed from vehicle. The winch power take-off control lever is mounted on a special stud at transmission. Linkage comprising rods and cross shaft fitted with pickup levers, connects winch control lever with power take-off shift shaft arm (fig. 143). After chassis serial No. 398029, the two control levers for shifting dual drive power take-off pivot on a special stud at transmission. Winch power take-off control lever is connected directly with power take-off shift shaft arm, while the hoist power take-off control lever is connected through a rod link with the auxiliary shift rod at power take-off (fig. 143). Two lever locks are attached to cab floor pan to prevent accidental engagement of power take-off assembly.

POWER TAKE-OFF AND CONTROLS

b. Dual Power Take-off Removal. Removal procedure which follows is for all dual drive power take-off assemblies except as otherwise stated in text. This operation may be necessary if the transmission is being replaced by the consent of higher authority.

(1) **DRAIN LUBRICANT.** Remove transmission filler plug and power take-off drain plug and allow lubricant to drain into suitable receptacle.

(2) **REMOVE POWER TAKE-OFF TO TRANSMISSION BRACE AND DISCONNECT WINCH DRIVE SHAFT.** Accomplish operations b (2) and (3) of paragraph 157.

(3) **DISCONNECT HOIST DRIVE SHAFT.** Loosen set screw in U-joint yoke at rear of power take-off, remove drive shaft front steady bearing from support bracket, and loosen stud nut at drive shaft rear steady bearing. Pull drive shaft down and at same time pull U-joint off auxiliary drive shaft at power take-off.

(4) **DISCONNECT CONTROL LINKAGE** (Prior to Serial No. 398030) (fig. 142). Remove clevis pins which connect rods to power take-off shifting mechanism and allow rods to swing down and away from assembly.

(5) **DISCONNECT CONTROL LEVERS** (After Serial No. 398029) (fig. 143). With winch power take-off control lever moved forward to "HIGH" position, remove cotter pin and flat washer from lower end of lever. Loosen arm to shift screw and turn arm to disengage it from lever. Remove clevis pin from lower end of hoist power take-off control lever and remove lever to shift rod link by withdrawing cotter pin and removing rod link from eye in shift rod.

(6) **REMOVE POWER TAKE-OFF ASSEMBLY FROM VEHICLE.** Accomplish operation b (6) in paragraph 157.

c. Dual Power Take-off Installation.

(1) **ATTACH ASSEMBLY TO TRANSMISSION AND CONNECT WINCH DRIVE SHAFT.** Accomplish operations c (1) through (4) in paragraph 157.

(2) **CONNECT HOIST DRIVE SHAFT.** Be certain that key is in slot in auxiliary drive shaft at power take-off. Raise hoist drive shaft and guide drive shaft front U-joint yoke onto shaft at power take-off. Attach drive shaft front steady bearing to support bracket and tighten bearing stud nut at both the front and rear bearings. Tighten set screw in front U-joint yoke to hold joint on power take-off auxiliary drive shaft.

(3) **CONNECT CONTROL LINKAGE** (Prior to Serial No. 398030). Attach rods to shift rod and shift shaft at power take-off, using clevis pins secured with new cotter pins (fig. 142).

(4) **CONNECT CONTROL LEVERS** (After Serial No. 398029).

(a) *Connect Hoist Control Lever.* Place hoist power take-off control lever in the "OUT" position and engage lever lock on cab floor. Pull auxiliary shift rod out to disengaged position. If rod link (fig. 143) cannot be installed without moving shift rod, loosen rod eye lock nut and screw eye in or out, as necessary, to make possible rod link installation. Install rod link, using clevis pin to attach rod

TRUCK, 2 1/2-TON, 6 x 6

to lever, and two flat washers and two cotter pins at shift rod eye. Tighten rod eye lock nut at finish of operation.

(b) *Connect Winch Control Lever.* With arm to shift shaft cap screw loosened to allow arm to be turned, place flat washer on lower end of lever; then turn arm and move lever as necessary to engage elongated hole in arm with lower end of lever. Place flat washer on lever and against shift shaft arm, install cotter pin in lever, and tighten arm to shift shaft screw firmly. Lock lever in neutral position.

(5) **INSTALL LUBRICANT.** Install lubricant as directed in paragraph 157 c (7).

d. **Controls and Linkage Removal** (Prior to chassis Serial No. 398030) (fig. 142).

(1) **REMOVE FLOOR PAN.** Lift out transfer case control lever seal, remove floor pan retaining screws, and remove floor pan from vehicle.

(2) **REMOVE WINCH CONTROL LEVER.** Pull out cotter pin and remove clevis pin from yoke at cross shaft arm. Remove cotter pin and retaining washer from pivot stud at lower end of control lever and slide lever off stud. Use suitable wrench and remove pivot stud and lock washer. Remove clevis pin from rod yoke at lever and remove rod assembly from lever. Remove adjustable rod assembly from lever. Remove adjustable rod end clevis from end of rod.

(3) **REMOVE POWER TAKE-OFF SHIFTER CONTROL RODS** (fig. 142). Remove clevis pins from yokes at both ends of two shifter shaft control rods and remove rods from vehicle.

(4) **REMOVE POWER HOIST CONTROL LEVERS AND CROSS SHAFT ASSEMBLY.** Disconnect power hoist valve control rod by removing clevis pin from rod yoke at control lever. Unhook and remove brake pedal return spring. Remove four cross shaft bracket mounting bolts,

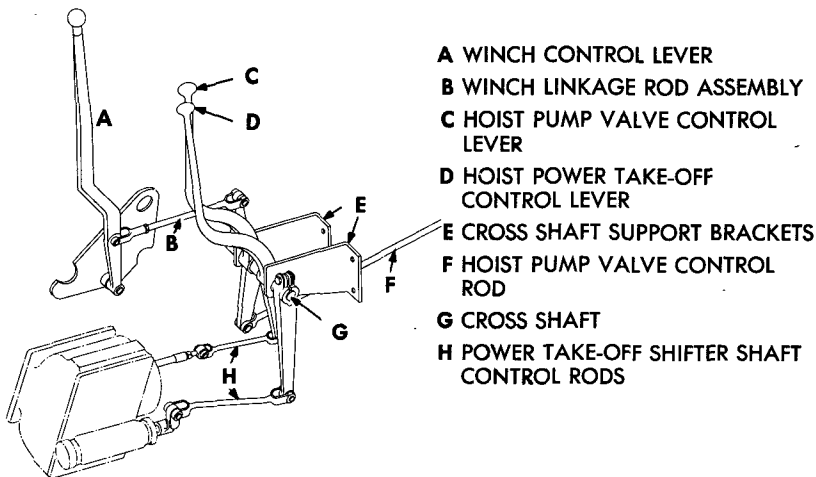
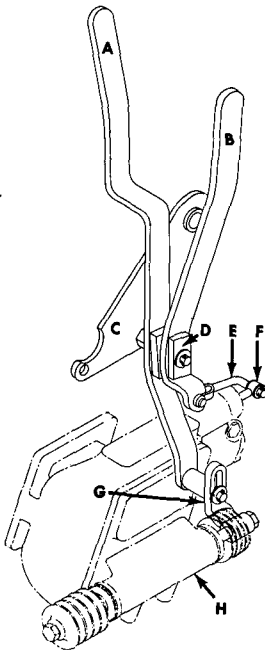

Figure 142—Dual Drive Power Take-Off Controls and Linkage (Early Type)

RA PD 64776

POWER TAKE-OFF AND CONTROLS



- A WINCH POWER TAKE-OFF CONTROL LEVER
- B HOIST POWER TAKE-OFF CONTROL LEVER
- C TRANSFER CASE CONTROL CROSS SHAFT BRACKET
- D SPECIAL STUD
- E LEVER TO SHIFT ROD LINK
- F POWER TAKE-OFF AUXILIARY DRIVE SHIFT ROD
- G SHIFT SHAFT ARM
- H DUAL DRIVE POWER TAKE-OFF ASSEMBLY

RA PD 333048

Figure 143—Dual Drive Power Take-Off Controls and Linkage (Late Type)

nuts, lock washers, and brake pedal return spring clip, then remove cross shaft assembly from vehicle.

(5) **DISASSEMBLE CONTROL LEVERS, CROSS SHAFT, AND BRACKETS ASSEMBLY.** Place assembly in vise and remove clamp bolt from one cross shaft arm, then remove arm and Woodruff key from shaft. Strip two brackets, two hoist control levers, and one spacer from cross shaft. Grip cross shaft in vise and remove clamp bolt, arm, and Woodruff key from shaft.

e. **Controls and Linkage Removal (After Chassis Serial No. 398029) (fig. 143).**

(1) **REMOVE FLOOR PAN.** Lift out transfer case control levers seal, remove floor pan retaining screws, and remove floor pan from vehicle.

(2) **REMOVE CONTROL LEVERS.** Remove clevis pin from lower end of hoist power take-off control lever, and withdraw cotter pin from lower end of winch power take-off control lever. Loosen arm to shift shaft cap screw; then turn shift shaft arm to disengage it from lever. Do not lose flat washers used at each side of arm. Remove cotter pin and flat washer from stud at transmission then remove both levers from stud.

(3) **REMOVE TRANSMISSION STUD AND AUXILIARY SHIFT ROD LINK.** With suitable wrench remove stud from transmission case.

TRUCK, 2½-TON, 6 x 6

Withdraw cotter pin from shift rod to lever link, which is connected to auxiliary shift rod eye, and remove rod link and flat washers.

f. Controls and Linkage Installation (Prior to Chassis Serial No. 398030) (fig. 142).

(1) **ASSEMBLE CONTROL LEVERS, CROSS SHAFT, AND BRACKETS ASSEMBLY.** Place cross shaft in vise, tap a Woodruff key into slot in shaft, and slide short cross shaft arm onto shaft and into position. Install and tighten clamp bolt in arm. Coat cross shaft with chassis grease and slide cross shaft inner bracket assembly over shaft and against cross shaft arm. Assemble hoist power take-off control lever, spacer, hoist valve control lever, and cross shaft outer bracket on cross shaft bracket assembly in order mentioned. Tap Woodruff key into slot at end of cross shaft and slide long cross shaft arm into position on cross shaft. Install and tighten clamp bolt to hold long arm in position on cross shaft.

(2) **INSTALL CONTROL LEVERS, CROSS SHAFT, AND BRACKETS ASSEMBLY.** Position assembly against transfer case support with mounting bolt holes alined. Place brake pedal return spring clip on longest mounting bolt and install this bolt in lower hole of inner cross shaft bracket. Install other three mounting bolts, install four nuts and lock washers on mounting bolts, and tighten securely.

(3) **INSTALL POWER TAKE-OFF SHIFT SHAFT CONTROL RODS** (fig. 142). Connect shorter rod between upper power take-off shift rod and lower end of hoist power take-off control lever, using clevis pins secured by new cotter pins at both ends of rod. Connect longer rod between arm on cross shaft and shift shaft arm at lower power take-off shift shaft. Install clevis pins at both ends of rod and secure with new cotter pins.

(4) **CONNECT HOIST VALVE CONTROL ROD.** Connect hoist valve control rod to lower end of hoist valve control lever using clevis pin and secure with new cotter pin.

(5) **INSTALL WINCH CONTROL LEVER.** Install "pivot" stud in bracket at left side of transmission. Position eye in lower end of winch control lever on "pivot" stud and install retaining washer and new cotter pin.

(6) **INSTALL ADJUSTABLE ROD ASSEMBLY** (fig. 142). Connect rod to cross shaft arm using clevis pin secured by cotter pin and start adjustable clevis on threads at other end of rod. Place power take-off in neutral position between reverse and low gear positions by sliding shift shaft forward into power take-off housing as far as it will go, then pull shaft out to first notch. Screw adjustable clevis onto rod far enough so that clevis pin can be inserted through rod yoke and control lever without movement of shift shaft.

(7) **INSTALL FLOOR PAN.** Guide floor pan over control levers and into position in cab then install retaining screws. Install transfer case control levers seal. Lock levers in neutral position.

POWER TAKE-OFF AND CONTROLS

g. **Controls and Linkage Installation** (After Chassis Serial No. 398029) (fig. 143).

(1) **INSTALL TRANSMISSION STUD AND AUXILIARY SHIFT ROD LINK.** Place lock washer on threaded end of stud. Install stud at transmission. Install rod link in auxiliary shift rod eye with flat washer at each side of eye; then install cotter pins in holes in rod (fig. 143).

(2) **INSTALL LEVERS ON TRANSMISSION STUD.** Place winch power take-off (longer) lever on stud at transmission with offset in handle toward center of vehicle; then place hoist power take-off (shorter) lever on stud with offset at lower end of lever toward power take-off assembly. Install flat washer and cotter pin at stud.

(3) **CONNECT WINCH POWER TAKE-OFF LEVER WITH SHIFT SHAFT ARM.** Loosen arm to shift shaft cap screw sufficiently to allow arm to be turned. Place flat washer on lower end of lever and turn arm and move lever as necessary to engage elongated hole in arm with lower end of lever. Place flat washer on lever against shift shaft arm and install cotter pin in lever. Tighten arm to shift shaft screw firmly.

(4) **CONNECT HOIST POWER TAKE-OFF CONTROL LEVER WITH ROD LINK.** Position lower end of hoist power take-off lever in yoke of rod link; then install clevis pin through yoke and lever. Secure clevis pin with cotter pin.

(5) **INSTALL FLOOR PAN.** Guide floor pan over control levers and into position in cab. Install retaining screws and transfer case control levers seal. Lock levers in neutral position.

Section XXIX

TRANSFER CASE AND CONTROLS

159. DESCRIPTION.

a. Transfer case is essentially a two-speed auxiliary unit consisting of a case, gears, and output shafts for transferring power to each of the three driving axles. The transfer case is located between the frame side rails just behind the transmission and is driven by the transmission through a propeller shaft. It is attached to brackets under the transfer case crossmember by cap screw. Shifting of transfer case gears is accomplished manually through levers in the cab (par. 16).

160. CONTROLS AND LINKAGE.

a. **Preliminary Instructions.** The following operations are given in logical sequence for adjusting, removing, or installing all of the controls and linkage; however, any part (or parts) may be inde-

TRUCK, 2 1/2-TON, 6 x 6

pendently adjusted, removed, or installed if so desired. Procedures are the same on vehicles equipped with split or banjo type axles. Refer to figures 144 and 145.

b. Declutching (Front Axle) Control Lever Adjustment.

(1) **DISCONNECT CONTROL ROD.** Disconnect declutching control rod from declutching control lower inner lever by removing cotter pin and clevis pin from adjustable yoke.

(2) **DETERMINE POPPET BALL SEAT POSITIONS.** Move declutching shifter shaft at transfer case in and out to make sure poppet ball is seating in grooves in shaft. Movement of shaft will indicate when poppet ball is seated. Leave shaft pulled out in the disengaged position.

(3) **ADJUST CONTROL ROD.** With declutching control lever slightly forward of a vertical position, the holes in the adjustable yoke on declutching control rod should be in alinement with the hole in the declutching control lower inner lever. Loosen lock nut behind adjustable yoke and turn yoke onto or off of rod as necessary to aline holes.

(4) **CONNECT CONTROL ROD.** When correct adjustment is obtained, connect declutching control rod to declutching control lower inner lever, using clevis pin and new cotter pin. Tighten lock nut behind adjustable yoke.

c. High and Low Speed Control Lever Adjustment.

(1) **DISCONNECT CONTROL ROD.** Disconnect high and low speed control rod (front) from high and low speed control lower inner lever by removing cotter pin and clevis pin from adjustable yoke on forward end of rod.

(2) **DETERMINE POPPET BALL SEAT POSITIONS.** Move high and low speed shifter shaft at transfer case in and out to make sure that poppet ball is seating in grooves in shaft. Movement of shaft will indicate when poppet ball is seated. Leave shaft in neutral position, between high and low.

(3) **ADJUST CONTROL ROD.** With declutching (front axle) control lever in disengaged position, set high and low speed control lever so there is a 1/8-inch clearance between this lever and the stop pad on declutching control lower outer lever. With high and low speed control lever in this position, holes in adjustable yoke on forward end of high and low speed control rod (front) should be in alinement with hole in high and low speed control lower lever. Loosen lock nut at rear of adjustable yoke and turn yoke onto or off of rod as necessary to aline holes.

(4) **CONNECT CONTROL ROD.** When correct adjustment is obtained, connect high and low speed control rod (front) to high and low speed control lower lever, using clevis pin and new cotter pin. Tighten lock nut behind adjustable yoke.

d. Control Rods Removal. Removal of any of the three control rods consists of removing the cotter pin and clevis pin from the yoke at each end of the rods.

TRANSFER CASE AND CONTROLS

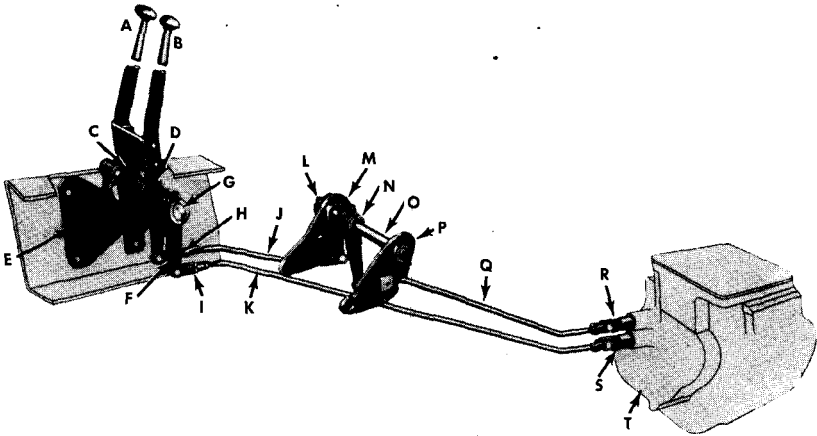

- | | | | |
|---|--|---|--|
| A | DECLUTCHING CONTROL UPPER LEVER | J | HIGH AND LOW SPEED CONTROL ROD (FRONT) |
| B | HIGH AND LOW SPEED CONTROL UPPER LEVER | K | DECLUTCHING CONTROL ROD |
| C | DECLUTCHING CONTROL LOWER OUTER LEVER | L | CROSS SHAFT RIGHT-HAND LEVER |
| D | HIGH AND LOW SPEED CONTROL LOWER LEVER | M | CROSS SHAFT RIGHT-HAND SUPPORT BRACKET |
| E | CONTROL LEVER BRACKET | N | CROSS SHAFT LEFT-HAND LEVER |
| F | DECLUTCHING CONTROL LOWER INNER LEVER | O | CROSS SHAFT |
| G | CONTROL LEVER SHAFT | P | CROSS SHAFT LEFT-HAND SUPPORT BRACKET |
| H | HIGH AND LOW SPEED CONTROL ROD ADJUSTABLE YOKE | Q | HIGH AND LOW SPEED CONTROL ROD (REAR) |
| I | DECLUTCHING CONTROL ROD ADJUSTABLE YOKE | R | HIGH AND LOW SPEED SHIFTER SHAFT |
| | | S | DECLUTCHING SHIFTER SHAFT |
| | | T | TRANSFER CASE |

RA PD 332979

**Figure 144—Transfer Case Controls and Linkage
(Used with Banjo Type Axles)**

e. High and Low Speed Control Cross Shaft and Brackets Removal.

(1) **REMOVE RIGHT-HAND SUPPORT BRACKET AND CROSS SHAFT ASSEMBLY.** Pull retainer spring from left-hand end of cross shaft. Remove two nuts and lock washers from studs attaching right-hand support bracket to transmission. Pull bracket off studs and pull cross shaft out of left-hand bracket and remove the assembly from the vehicle.

(2) **REMOVE LEFT-HAND SUPPORT BRACKET.** Loosen rear adjusting nut on transmission strut rod eye bolt, then remove cotter pin and clevis pin attaching forward end of strut rod to left-hand cross shaft support bracket. On vehicles without power take-off, remove two nuts and lock washers from studs attaching left-hand support bracket to transmission and pull bracket off studs. On vehicles with power take-off, remove power hoist and/or winch control levers from stud in left-hand side of transmission (par. 157 or 158). Remove control lever stud, remove nut and lock washer from forward stud, and remove bracket.

(3) **DISASSEMBLE LEVERS, CROSS SHAFT, AND BRACKETS.** Loosen clamp bolt in each lever and slide levers off ends of shaft. Remove Woodruff keys from shaft, then pull shaft out of bracket.

TRUCK, 2 1/2-TON, 6 x 6

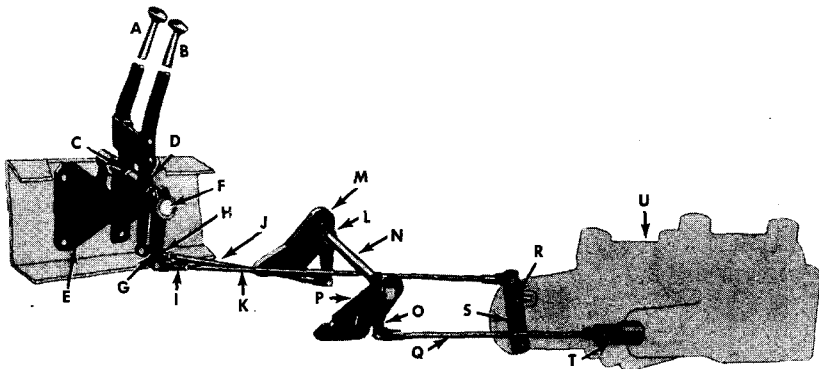

- | | | | |
|---|--|---|--|
| A | DECLUTCHING CONTROL UPPER LEVER | J | HIGH AND LOW SPEED CONTROL ROD (FRONT) |
| B | HIGH AND LOW SPEED CONTROL UPPER LEVER | K | DECLUTCHING CONTROL ROD |
| C | DECLUTCHING CONTROL LOWER OUTER LEVER | L | CROSS SHAFT RIGHT-HAND LEVER |
| D | HIGH AND LOW SPEED CONTROL LOWER LEVER | M | CROSS SHAFT RIGHT-HAND SUPPORT BRACKET |
| E | CONTROL LEVER BRACKET | N | CROSS SHAFT |
| F | CONTROL LEVER SHAFT | O | CROSS SHAFT LEFT-HAND LEVER |
| G | DECLUTCHING CONTROL LOWER INNER LEVER | P | CROSS SHAFT LEFT-HAND SUPPORT BRACKET |
| H | HIGH AND LOW SPEED CONTROL ROD ADJUSTABLE YOKE | Q | HIGH AND LOW SPEED CONTROL ROD (REAR) |
| I | DECLUTCHING CONTROL ROD ADJUSTABLE YOKE | R | DECLUTCHING SHIFT SHAFT |
| | | S | DECLUTCHING SHIFT LEVER |
| | | T | HIGH AND LOW SPEED SHIFT SHAFT |
| | | U | TRANSFER CASE |

RA PD 332989

**Figure 145—Transfer Case Controls and Linkage
(Used with Split Type Axles)**

f. Control Levers Removal.

(1) **REMOVE FLOOR PAN.** Lift floor seal up over ends of transfer case control levers and hand brake lever. Remove 12 floor pan cap screws and lock washers and lift floor pan up over levers and out of cab.

(2) **REMOVE UPPER LEVERS.** Remove two nuts, lock washers, and bolts attaching each upper lever to lower lever and remove upper levers.

(3) **REMOVE HAND BRAKE LEVER AND BRACKET.** Remove cotter pin and clevis pin attaching hand brake rod to hand brake lever. Remove two cap screws and washers attaching hand brake bracket to transmission cover and lift hand brake and lever assembly out of vehicle.

(4) **REMOVE TRANSMISSION COVER ASSEMBLY.** On vehicles equipped with power take-off, remove power take-off support bracket by removing four cap screws, two at top and two at bottom. Remove cap screw attaching speedometer cable clip to cover. Move gear-shift lever into neutral position. Thoroughly clean transmission cover with dry-cleaning solvent. Remove cover to case cap screws and lift cover assembly off from transmission case. **CAUTION: Do not change position of transmission gears while cover is removed. Cover transmission opening with cloth or paper to prevent dirt or tools from dropping into case.**

TRANSFER CASE AND CONTROLS

(5) **REMOVE LOWER LEVERS.** Loosen clamp bolt in declutching control lower inner lever and slide lever off end of shaft. Remove Woodruff key from shaft. Slide high and low control lower lever off end of shaft. Loosen clamp bolt in declutching control lower outer lever and slide lever outward (to right) on shaft until Woodruff key is exposed. Remove Woodruff key, then slide shaft inward (toward transmission) and remove lever from right-hand end of shaft.

g. Control Levers Installation.

(1) **INSTALL LOWER LEVERS.** Insert control lever shaft through bracket inner bushing with keyway end of shaft toward center of vehicle. Position declutching control lower outer lever on right-hand end of shaft with stop pad toward center of vehicle. Move shaft outward (to right) through support bracket inner bushing and declutching control lever until keyseat in shaft is exposed between lever and inner bushing in bracket. Tap Woodruff key into keyseat in shaft, aline key with keyway in lever, and move shaft outward (to right) until outer end of shaft enters right-hand bushing in bracket. Place high and low speed control lower lever over left-hand end of shaft with groove in lever toward center of vehicle. Tap Woodruff key into keyseat in inner end of shaft and install declutching control lower inner lever on shaft, with key alined with keyway in lever. With inner end of shaft even with inner side of declutching control lower inner lever, tighten clamp bolt in declutching control lower inner lever. Locate shaft in support bracket so levers are free and with declutching control outer lever against inner bushing in bracket; then tighten clamp bolt in declutching control lower outer lever.

(2) **INSTALL TRANSMISSION COVER ASSEMBLY.** Position a new gasket on top of transmission case. Place gearshift lever into neutral position and place cover assembly over transmission case with one edge of cover resting on corresponding edge of case and other edge tilted up. Visually check alinement of shift forks in cover with collars on gears in transmission. If gears have been moved, slide them on shaft as necessary to aline collars with forks. Make sure first and reverse rocker arm is positioned to engage rocker lug on left-hand shift rod in cover, then lower cover assembly into place on transmission. Install eight cover to case cap screws, and install power take-off support bracket on left-hand side (if used). Attach speedometer cable clip to left side of cover, using cap screw and lock washer. Move gearshift lever to all positions. If gearshift lever binds, or if gears cannot be easily shifted, remove cover and recheck alinement of shift forks and collars in gears.

(3) **INSTALL HAND BRAKE LEVER AND BRACKET.** Position hand brake lever and bracket assembly on right-hand side of transmission cover and attach with two cap screws and lock washers. The forward cap crew also attaches the engine ground strap, using a flat washer between the ground strap and lock washer. Connect hand brake rod to hand brake lever, using clevis pin and new cotter pin, and adjust hand brake (par. 193).

(4) **INSTALL UPPER LEVERS.** Install upper levers on high and low speed control lower lever and declutching control lower outer

TRUCK, 2 1/2-TON, 6 x 6

lever, attaching each with two bolts, nuts, and lock washers.

(5) **INSTALL FLOOR PAN.** Install floor pan over levers in cab and attach with 12 cap screws and lock washers. Install floor seal over hand brake lever and transfer case control levers.

h. High and Low Speed Control Cross Shaft and Brackets Installation.

(1) **ASSEMBLE LEVERS, CROSS SHAFT, AND RIGHT-HAND BRACKET.** Insert cross shaft through right-hand cross shaft support bracket, with grooved end of shaft toward left side of vehicle. Slide anti-rattle over left end of cross shaft. Tap Woodruff key into key-seats in shaft and install cross shaft levers on shaft. Tighten clamp bolts in levers firmly.

(2) **INSTALL RIGHT-HAND SUPPORT BRACKET AND CROSS SHAFT ASSEMBLY.** Position right-hand bracket and cross shaft assembly with holes in bracket over two studs in right-hand side of transmission. Install nuts and lock washers on studs and tighten firmly.

(3) **INSTALL LEFT-HAND SUPPORT BRACKET.** On vehicles without power take-off, place left-hand bracket over studs in left-hand side of transmission and over left-hand end of cross shaft. Install nuts and lock washers on studs and tighten firmly. Install retainer spring on left-hand end of cross shaft. Connect and adjust transmission strut rod (par. 155). On vehicles with power take-off, the procedure is the same except that the rear stud is replaced by a power hoist and/or winch control lever stud. Install power hoist and/or winch control levers (pars. 157 and 158).

i. Control Rods Installation. Check clevis pins for wear and discard any that are not full size. Obtain new pins for installation. Attach high and low speed control rod (rear) to high and low speed shifter shaft at transfer case and to left-hand cross shaft lever, using clevis pins and new cotter pins. Attach high and low speed control rod (front) to right-hand cross shaft lever in same manner, with adjustable yoke toward front of vehicle. Connect declutching control rod to declutching shifter shaft, using clevis pin and new cotter pin, with adjustable yoke toward front of vehicle. Adjust controls and connect rods to their respective control levers (subpars. **b** and **c** above). Lubricate linkage as directed in Section VIII.

161. TRANSFER CASE REMOVAL.

a. Drain Lubricant. Remove drain and filler plugs and allow lubricant to drain from transfer case. After draining, install and tighten plugs.

b. Disconnect Control Rods (fig. 144 or 145). Disconnect high and low speed control rod (rear) and declutching control rod from shifter shafts at transfer case by removing cotter pins and clevis pins.

c. Disconnect Speedometer Cable. Disconnect speedometer cable from transfer case idler shaft front cap by unscrewing knurled nut with pliers and pulling cable out of speedometer driven gear shaft.

TRANSFER CASE AND CONTROLS

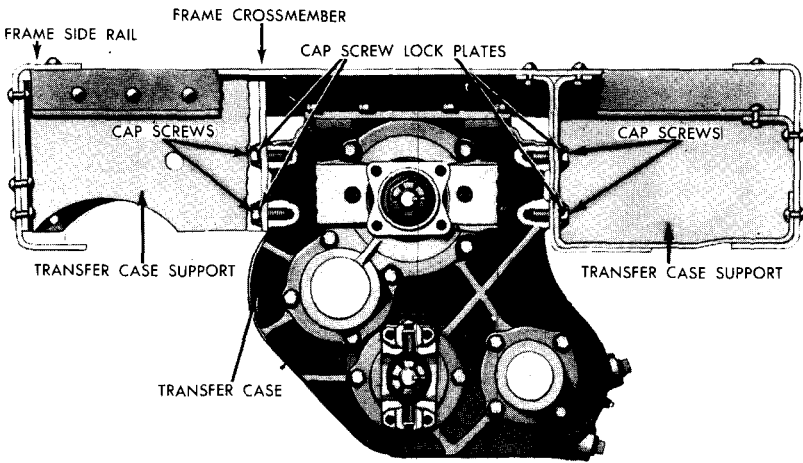

Figure 146—Transfer Case Mounting (Used with Banjo Type Axles)

RA PD 332887

d. Disconnect Hand Brake Control Rod and Propeller Shafts. Disconnect hand brake control rod at rear of transfer case by removing cotter pin and clevis pin. Disconnect propeller shafts at transfer case, two in front and two at rear.

e. Remove Transfer Case.

(1) **WITH BANJO TYPE AXLES** (fig. 146). Place dolly jack under transfer case and raise into position to support case. Bend cap screw lock plates away from cap screw heads and remove eight cap screws, four on each side. Lower transfer case on jack and withdraw from under vehicle.

(2) **WITH SPLIT TYPE AXLES** (fig. 147). Lift co-driver's seat up and latch in raised position. Remove access plate from cab floor just to the right of the driver's seat. On late vehicles, remove spare parts container from under co-driver's seat. Position jack under transfer case and raise into position to support case. Bend cap screw lock plates away from cap screw heads and remove four cap screws, two from crossmember and two from transfer case support. Lower transfer case on jack and remove from under vehicle. Do not lose spacers from top of transfer case.

f. Remove Hand Brake Assembly. Remove hand brake assembly from rear of transfer case (pars. 194 and 195).

162. TRANSFER CASE INSTALLATION.

a. Install Hand Brake Assembly. Install hand brake assembly on rear of transfer case (pars. 194 and 195).

b. Install Transfer Case.

(1) **WITH BANJO TYPE AXLES** (fig. 146). Place transfer case assembly on dolly jack and roll into approximate position under

TRUCK, 2½-TON, 6 x 6

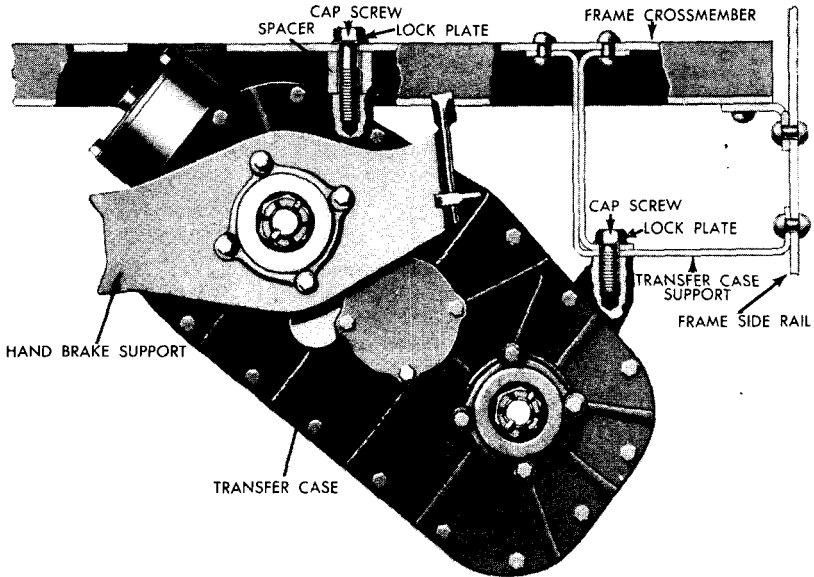

Figure 147—Transfer Case Mounting (Used with Split Type Axles)

RA PD 332885

vehicle. Raise transfer case into position between supports and align holes in supports with threaded holes in case. With lock plates under cap screw heads, install eight cap screws, four in each side. Tighten cap screws firmly and bend lock plates against cap screw heads. Lower dolly jack and remove from under vehicle.

(2) **WITH SPLIT TYPE AXLES** (fig. 147). Place transfer case on dolly jack and roll into approximate position under vehicle. Raise transfer case into position, being sure spacers are in place between top of transfer case and crossmember. With lock plates installed under cap screw heads, install four cap screws, two through crossmember and spacers and two through transfer case support. Tighten cap screws firmly and bend lock plates against cap screw heads. Install access plate on cab floor and install spare parts box (if used). Lower jack and remove from under vehicle.

c. **Connect Hand Brake Control Rod and Propeller Shafts.** Connect hand brake control rod at rear of transfer case, using clevis pin and new cotter pin. Adjust hand brake (par. 193). Connect propeller shafts to transfer case, two at front and two at rear (par. 176).

d. **Connect Speedometer Cable.** Connect speedometer cable to transfer case idler shaft front cap. Be sure that tongue on end of cable meshes with speedometer driven gear shaft and tighten knurled nut with pliers.

e. **Connect Control Rods** (fig. 144 or 145). Connect high and low speed control rod (rear) and declutching control rod to their

TRANSFER CASE AND CONTROLS

respective shifter shafts at transfer case, using clevis pins and new cotter pins. Adjust transfer case control linkage (par. 160).

f. **Lubricate.** Check condition of magnetic drain plug [(GM-602745) G85-32-02340], and replace if necessary. Fill transfer case to proper level with lubricant as recommended in Section VIII. Make sure drain and filler plugs are tight.

Section XXX

FRONT AXLE

163. DESCRIPTION.

a. **Description.** This section covers two types of axles, the split type and the banjo type (fig. 7, Section II). The split or two-piece type is so called since the housing is made in two pieces, bolted together at the differential. The banjo type housing is of one-piece construction. Each is a single-reduction, bevel-gear driving unit with full-floating axle shafts having constant velocity universal joints at the steering knuckles. Both types are mounted on semi-elliptic springs.

b. **Operation.** Power is transmitted from the transfer case to the front axle by a tubular propeller shaft. The engagement and disengagement of the front axle is controlled at the transfer case by a shift lever in the cab. Detailed instructions covering front axle engagement and disengagement are given in paragraph 16.

c. **Data.**

| <i>Type</i> | <i>GM Number</i> |
|--|------------------|
| Banjo Type (with conventional brake drums)..... | 3663017 |
| Banjo Type (with demountable brake drums)..... | 3678601 |
| Split Type (with Bendix-Weiss universal joints)..... | 2162378 |
| Split Type (with Rzeppa universal joints)..... | 2170974 |

164. FRONT WHEEL ALINEMENT.

a. **Front wheel alinement** has a major effect on steering from a standpoint of control, ease of steering, and safety. Front wheel mis-alinement is a major cause of premature and uneven tire wear. The factors involved in front wheel alinement are caster, camber, turning angle, and toe-in. These factors apply to both the split type and banjo type axles.

b. **Caster.** Front axle caster is the inclination of the center line through the upper and lower steering knuckle trunnions toward the rear of the vehicle (L, fig. 148). Caster is established by design and will be changed only by the shifting of the front axle on the

TRUCK, 2½-TON, 6 x 6

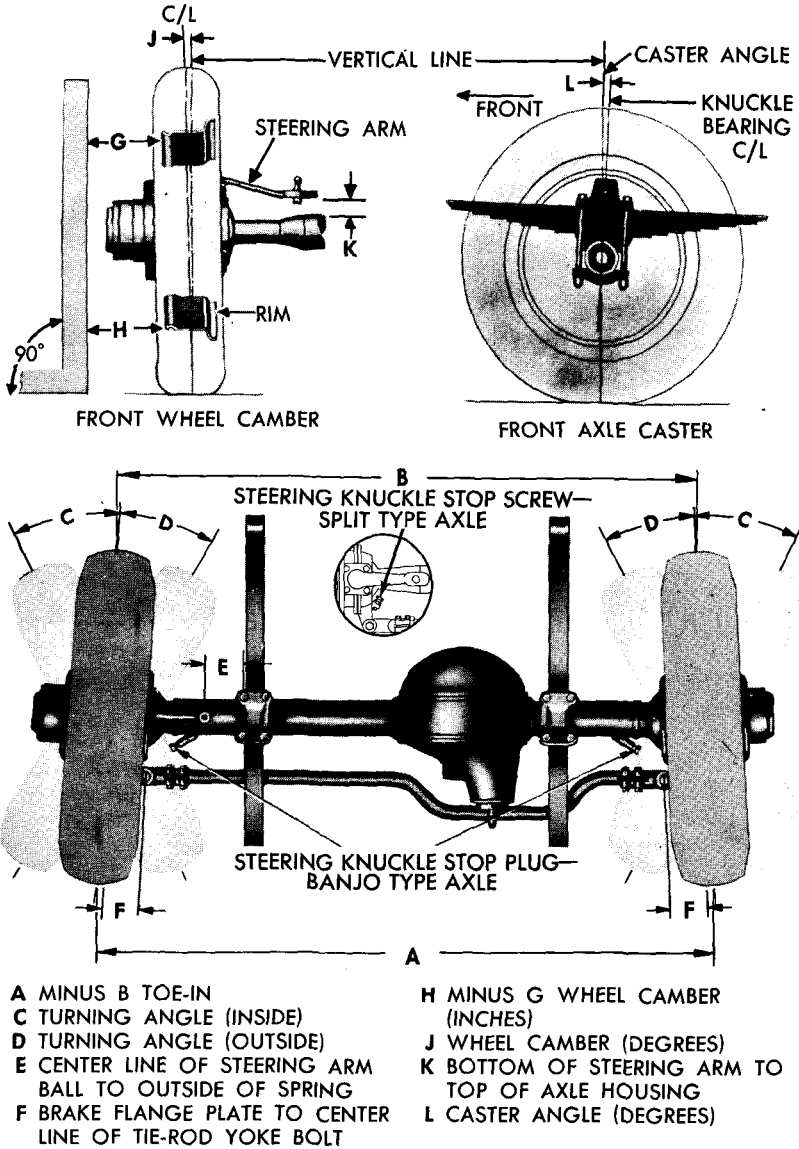

RA PD 332781

Figure 148—Front Wheel and Axle Alinement Chart

springs or by the distortion of the chassis frame or springs. There is no adjustment for caster.

c. **Camber.** Front wheel camber is the outward inclination of the wheels as viewed from the front of the vehicle, that is, the wheels are farther apart at the top than at the bottom (J, fig. 148). There is

FRONT AXLE

no adjustment for camber; however, loose wheel bearings, loose knuckle trunnion bearings, a bent steering knuckle, or bent axle housing will affect camber.

d. **Turning Angle.** Front wheel turning angle is the maximum angle through which the wheels may be turned from the straight-ahead position. This angle is greater for the inside wheel (C, fig. 148), than for the outside wheel (D, fig. 148).

e. **Toe-in.** Front wheel toe-in is the amount by which the wheels are closer together at the front than at the rear, with the wheels in a straight-ahead position. (A minus B, fig. 148.) Camber causes both wheels to have a tendency to turn outward from the vehicle. Toe-in counteracts this tendency and causes the wheels to roll straight ahead with no scuffing action.

165. TOE-IN ADJUSTMENT.

a. **Toe-in Check** (fig. 148). Inflate tires to correct pressure (par. 198), and place vehicle on a smooth, level surface with the wheels in straight-ahead position. Place gage (41-G-510) between the wheels ahead of the axle, with the ends of the gage bearing against the tire side walls and with both pendant chains just touching the ground. Set gage so pointer registers zero. Move the vehicle forward until gage is brought into position in back of the axle, with both pendant chains just touching the ground. The pointer will indicate the amount of toe-in or toe-out. Correct toe-in on both the banjo and split type axles is $\frac{1}{16}$ — $\frac{3}{16}$ inch.

b. **Toe-in Adjustment.** Loose wheel bearings, worn bushings in steering knuckle supports, damaged wheels, a bent steering knuckle,

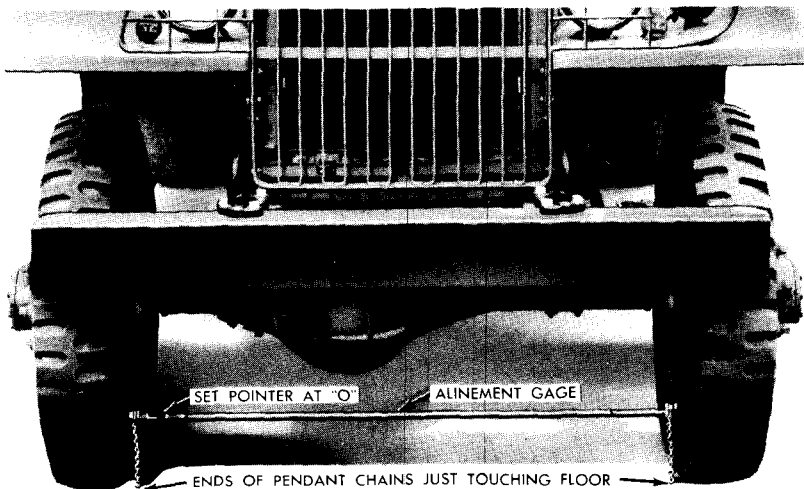

Figure 149—Checking Toe-In (Gage 41-G-510)

RA PD 332980

TRUCK, 2½-TON, 6 x 6

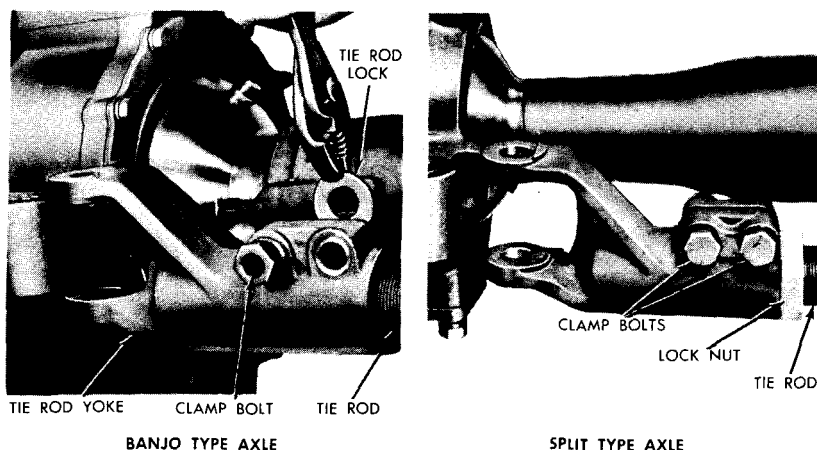

Figure 150—Tie Rod Yokes

RA PD 332904

a bent axle housing, or a bent or improperly adjusted tie rod will affect toe-in. Adjust the wheel bearings (par. 199) and replace the wheels, if damaged (par. 197), before adjusting the tie rod to correct toe-in.

(1) **REMOVE TIE ROD** (fig. 150). Remove tie rod (par. 166). On banjo type axles, remove the inner tie rod yoke clamp and lock from left-hand tie rod yoke and loosen all clamp bolts. On split type axles, loosen the yoke clamp bolts and loosen the lock nut at the left end yoke.

(2) **ADJUST TIE ROD** (fig. 151). Screw yokes onto or off of tie rod as required to correct toe-in. Toe-in will be increased about ⅛ inch by backing right-hand yoke (coarse threads) one turn further onto rod. Reversing this procedure will decrease toe-in by the same amount.

(3) **CHECK ADJUSTMENT.** After adjusting tie rod yokes, install tie rod yokes on steering knuckle supports (or inner flanges), and install each tie rod yoke bolt (fig. 152). It is not necessary to install nuts on yoke bolts until final adjustment has been made. Measure toe-in and readjust tie rod if necessary until toe-in measurement is correct.

(4) **INSTALL TIE ROD.** When adjustment is correct, reassemble tie rod yokes to steering knuckle supports (or inner flanges), install tie rod yoke bolts (fig. 152), and install nuts on bolts. Tighten nuts securely and install new cotter pins. On split type axles, tighten tie rod yoke clamp bolts and tighten lock nut at left-hand yoke (fig. 150). On banjo type axles, insert lock in left-hand tie rod yoke, making certain it is seated in keyway in tie rod, and aline hole in lock with clamp bolt hole (fig. 150). Insert clamp bolts, install nuts and lock washers, and tighten securely.

FRONT AXLE

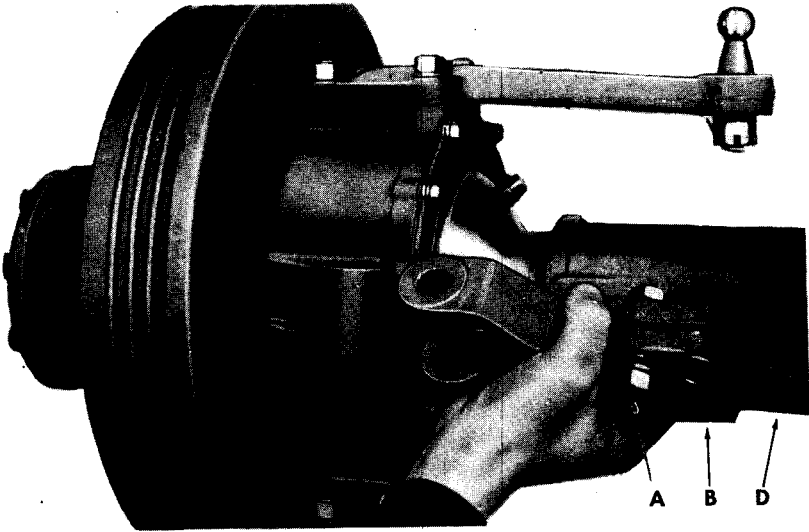

BANJO TYPE AXLE

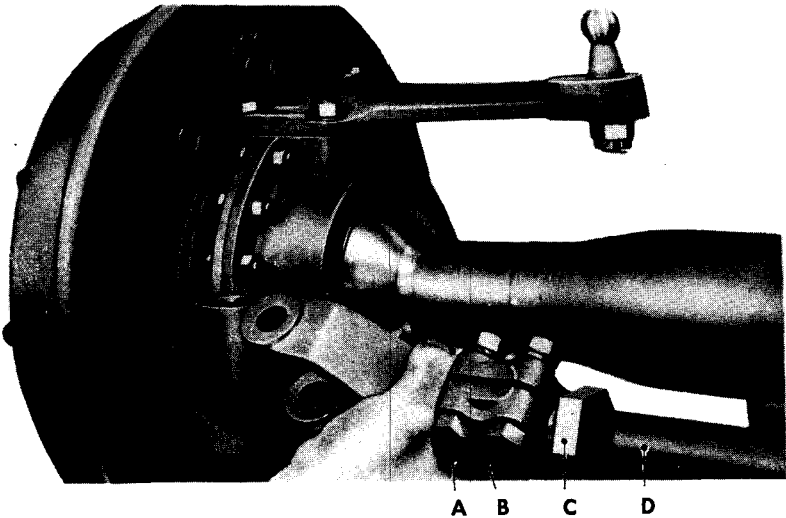

SPLIT TYPE AXLE

A TIE ROD YOKE CLAMP BOLT
B TIE ROD YOKE

C TIE ROD YOKE LOCK NUT
D TIE ROD

Figure 151—Adjusting Toe-In

TRUCK, 2½-TON, 6 x 6

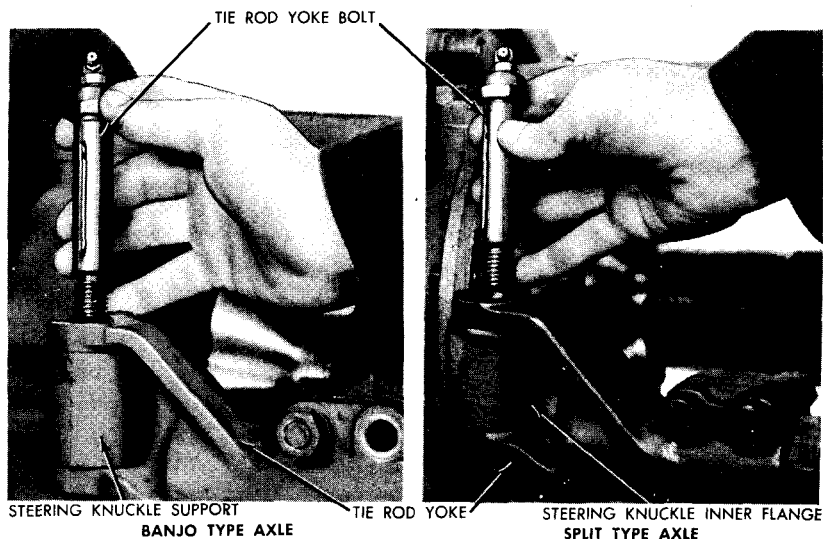

Figure 152—Installing Tie Rod Yoke Bolts RA PD 332846

166. TIE ROD.

a. The tie rod is a solid rod, threaded at each end with a double offset to clear the differential and pinion housing. The tie rod is connected to the steering knuckle supports (or inner flanges) by means of yokes, screwed onto the ends of the rod, and attached to the steering knuckle supports (or inner flanges) by tie rod yoke bolts, nuts, and cotter pins. On the banjo type axle (fig. 150), the tie rod is held in the correct relative position to the pinion housing by a lock at left end which is fitted into a keyway in the rod and held in place by the tie rod yoke inner clamp bolt. On the split type axle (fig. 150), this is accomplished by a lock nut tightened against the left end yoke. The threaded portion of each yoke is split and is held tightly on the rod by clamp bolts.

b. Removal.

(1) POSITION VEHICLE. Place vehicle on a level surface and apply hand brake. Place a jack under front axle housing and raise enough to take weight of vehicle off front wheels.

(2) REMOVE TIE ROD YOKE BOLTS. Remove cotter pin and nut from tie rod yoke bolt at each end of tie rod. Force bolts up out of tie rod yokes, and slide tie rod yokes off steering knuckle supports (or inner flanges).

c. Installation. Toe-in must be adjusted when installing tie rod. Complete instructions on adjusting toe-in and installing tie rod on both the split and banjo type axles are given in paragraph 165.

FRONT AXLE

167. AXLE SHAFT AND UNIVERSAL JOINTS.

a. **General.** The following procedures are to be used only to remove the axle shaft and universal joint assemblies for cleaning and inspection (par. 46), and special lubrication operations (Section VIII). Procedures apply to both the right- and left-hand assemblies unless otherwise stated in text.

b. **Axle Shaft and Universal Joint Removal (Banjo Type Axles).**

(1) **REMOVE WHEEL.** Jack up front end of vehicle, remove wheel stud nuts, and remove wheel and tire assembly.

(2) **REMOVE DRIVE FLANGE.** Remove eight cap screws and lock washers (or lock plate) attaching drive flange to hub. Install two drive flange cap screws in the two tapped holes in drive flange and pull drive flange off splined outer end of axle shaft by alternately turning in the two cap screws. Remove drive flange to hub gasket [(GM-3659733) G85-31-05780].

(3) **REMOVE HUB AND DRUM ASSEMBLY.** Remove wheel bearing adjusting nuts and remove hub and drum assembly.

(4) **REMOVE ANCHOR PLATE AND BRAKE SHOE ASSEMBLY** (fig. 168). Install wheel cylinder clamp on wheel cylinder to prevent ends coming off and remove brake shoe return spring. Remove six cap screws and lock washers attaching brake shoe anchor plate to anchor plate spacer and remove anchor plate and brake shoe assembly.

(5) **REMOVE ANCHOR PLATE SPACER AND OIL DEFLECTOR.** Remove 12 cap screws and lock washers attaching brake shoe anchor plate spacer, inner oil deflector, brake flange plate, and steering knuckle to steering knuckle support and remove anchor plate spacer and oil deflector.

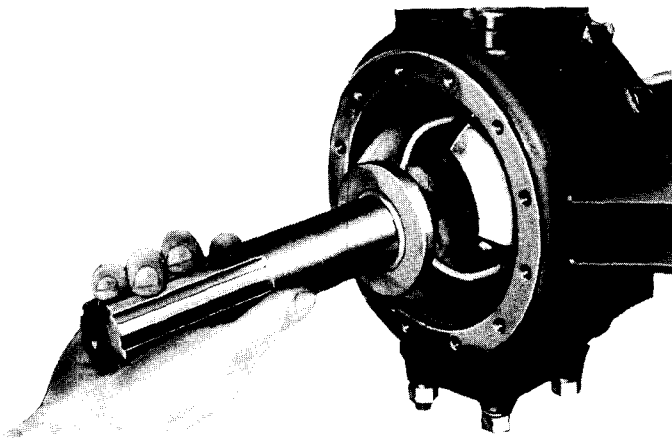

Figure 153—Removing Axle Shaft and Universal Joint Assembly (Banjo Type Axle)

RA PD 332925

TRUCK, 2½-TON, 6 x 6

(6) **REMOVE BRAKE FLANGE PLATE AND STEERING KNUCKLE.** Slide brake flange plate off steering knuckle and support it with a piece of wire to eliminate disconnecting brake hose. Remove steering knuckle and gasket from steering knuckle support.

(7) **REMOVE AXLE SHAFT AND UNIVERSAL JOINT ASSEMBLY** (fig. 153). Pull axle shaft and universal joint assembly out of axle housing.

c. Cleaning, Inspection, and Special Lubrication Operations (Banjo Type Axles).

(1) **CLEANING.** Thoroughly wash axle shaft and universal joint in dry-cleaning solvent to remove all old lubricant; also wash inside of steering knuckle support and housing outer end.

(2) **INSPECTION.** Inspect balls and ball races for grooved, scratched, or pitted condition. To determine if excessive play or backlash exists in the universal joint, place the assembly in a vise in a vertical position with the outer shaft up, and with vise jaws gripping the inner shaft just below the universal joint. Use soft metal or wood protectors in jaws of vise. Firmly push down on outer shaft so that it rests on center ball, and at the same time attempt to twist the joint in both directions. If any play or backlash is evident, report to higher authority. Inspect axle shaft thrust washers in steering knuckle and axle housing for excessive wear or damage. Examine axle shaft splines for nicks, cracks, or other damage. Report all worn or damaged conditions to higher authority.

(3) **SPECIAL LUBRICATION.** Pack new lubricant (Section VIII), well into universal joint until it fills all space between balls and universal joint yokes. Also spread lubricant on surfaces which contact thrust washers and bushing in steering knuckle.

d. Axle Shaft and Universal Joint Installation (Banjo Type Axles).

(1) **INSTALL AXLE SHAFT AND UNIVERSAL JOINT.** Using care not to damage oil seal in housing outer end, insert axle shaft and universal joint assembly into axle housing, guiding splined end of inner shaft into splined differential side gear.

(2) **INSTALL STEERING KNUCKLE.** Place steering knuckle over outer end of axle shaft and position against steering knuckle support, using a new gasket between knuckle and support. Milled slot on threaded end of steering knuckle must be at the top.

(3) **INSTALL BRAKE FLANGE PLATE, INNER OIL DEFLECTOR, AND BRAKE SHOE ANCHOR PLATE SPACER.** Place brake flange plate, inner oil deflector, and brake shoe anchor plate spacer on steering knuckle support, and install 12 cap screws and lock washers. Anchor plate spacer must be positioned with center line through any two opposite bosses horizontal. Tighten cap screws firmly.

(4) **INSTALL ANCHOR PLATE AND BRAKE SHOE ASSEMBLY.** Using six cap screws and lock washers, attach anchor plate and brake shoe assembly to anchor plate spacer and tighten cap screws firmly. Install brake shoe return spring and remove wheel cylinder clamp.

FRONT AXLE

(5) **INSTALL HUB AND DRUM ASSEMBLY.** Install hub and drum assembly and adjust wheel bearings (par. 199).

(6) **INSTALL DRIVE FLANGE.** Using a new drive flange gasket coated with grease, install drive flange over splined outer end of axle shaft and position against hub. Install drive flange cap screws and lock washers, and tighten to 85 - 95 foot-pounds.

(7) **INSTALL WHEEL.** Install wheel and tire assembly on hub, install wheel stud nuts, and tighten firmly. Lower jacks and remove from under vehicle.

(8) **LUBRICATE.** Lubricate steering knuckle and universal joint (Section VIII).

e. **Axle Shaft and Universal Joint Removal (Split Type Axles).** NOTE: *Two types of axle shaft and universal joints are used in split type axles—Bendix Weiss and Rzeppa. The following procedures cover both types with exceptions noted in text.*

(1) **REMOVE WHEEL.** Jack up front end of vehicle, remove wheel stud nuts, and remove wheel and tire assembly.

(2) **REMOVE DRIVE FLANGE.** Remove eight nuts and lock washers from studs attaching drive flange to hub. Remove universal joint stop bolt and stop from center of drive flange. Install two $\frac{3}{8}$ -inch cap screws in two tapped holes in drive flange. Pull drive flange off axle shaft and out of hub by alternately turning in the two cap screws. Remove drive flange to hub gasket [(GM-2144671) G57-01-94016].

(3) **REMOVE HUB AND DRUM ASSEMBLY.** Remove wheel bearing adjusting nuts and remove hub and drum assembly.

(4) **REMOVE OIL SHIELD AND BRAKE DUST SHIELD.** Remove 12 nuts and lock washers from studs attaching brake dust shield, oil shield, and steering knuckle to outer steering knuckle flange. Remove oil shield and brake dust shield; support brake dust shield with a piece of wire to eliminate disconnecting brake hose.

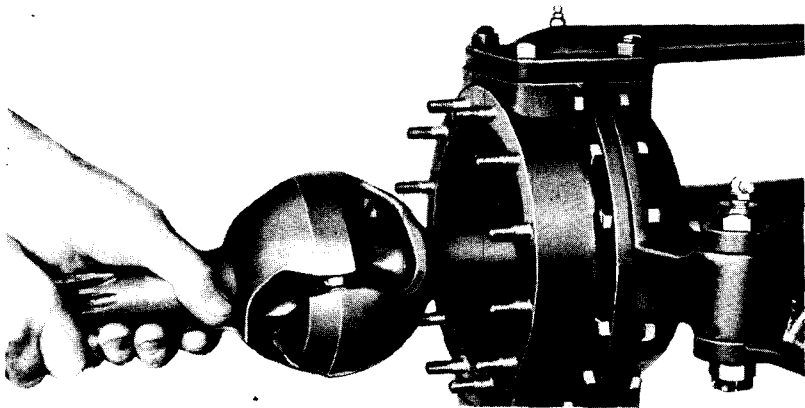

Figure 154—Removing Axle Shaft and Universal Joint Assembly (Split Type Axle)

RA PD 64662

TRUCK, 2½-TON, 6 x 6

(5) **REMOVE STEERING KNUCKLE.** Remove steering knuckle from outer steering knuckle flange. Knuckle can be loosened from flange by tapping on side of knuckle with a brass hammer and driving wedge blocks between the knuckle and flange.

(6) **REMOVE AXLE SHAFT AND UNIVERSAL JOINT ASSEMBLY** (fig. 154). Withdraw axle shaft and universal joint assembly from axle housing.

f. Cleaning, Inspection, and Special Lubrication Operations (Split Type Axles).

(1) **BENDIX-WEISS.** The Bendix-Weiss axle shaft and universal joint assemblies used in split type axles are essentially the same as those used in banjo type axles, and procedures given under subparagraph c above apply equally to these assemblies. **CAUTION:** *Do not disturb spacer pins in inner ends of shafts.*

(2) **RZEPPA.**

(a) **Cleaning.** Thoroughly wash axle shaft and universal joint assembly in dry-cleaning solvent to remove all old lubricant; also wash inside of steering knuckle flanges and housing outer end.

(b) **Inspection.** Check universal joint for excessive wear or rough operation by mounting the assembly in a vise with universal joint bell up and vise jaws gripping the shaft just below the universal joint. Use soft metal or wood protectors in vise jaws. Swing universal joint bell through its normal operating range and note any roughness or excessive looseness. If such a condition is evident, report to higher authority. Also check splines on axle shaft and universal joint bell for nicks, cracks, or other damage.

(c) **Special Lubrication.** Pack new lubricant (Section VIII) well into universal joint until it fills all space between balls, cage, inner race, and universal joint bell. Also spread grease on surface of universal joint bell which contacts bushing in steering knuckle.

g. Axle Shaft and Universal Joint Installation (Split Type Axles).

(1) **INSTALL AXLE SHAFT AND UNIVERSAL JOINT.** Using care not to damage oil seal in axle housing near differential, insert axle shaft and universal joint assembly into axle housing, guiding splined end of inner shaft into splined differential side gear.

(2) **INSTALL STEERING KNUCKLE, BRAKE DUST SHIELD, AND OIL SHIELD.** Slide steering knuckle over outer end of axle shaft and position on studs in outer steering knuckle flange with milled slot in threaded end at top. Install brake dust shield and oil shield on studs and attach with 12 nuts and lock washers.

(3) **INSTALL HUB AND DRUM ASSEMBLY.** Install hub and drum assembly and adjust wheel bearings (par. 199).

(4) **INSTALL DRIVE FLANGE.** Install drive flange over splined outer end of axle shaft, using a new gasket coated with grease between flange and hub. Aline holes in flange with studs in hub and push flange in against hub. Place universal joint stop in center of drive flange, install stop bolt through stop into end of axle shaft,

FRONT AXLE

and tighten firmly. Install eight nuts and lock washers on drive flange to hub studs and tighten nuts to 58-62 foot-pounds.

(5) **INSTALL WHEEL.** Install wheel and tire assembly on hub, install wheel stud nuts, and tighten firmly. Lower jacks and remove from under vehicle.

(6) **LUBRICATE.** Lubricate steering knuckle and universal joint (Section VIII).

168. FRONT AXLE REMOVAL.

a. Both the banjo and split type axles may be removed by the same procedure with exceptions noted in text.

b. **Position Vehicle.** Place vehicle on a level surface and apply hand brake to prevent vehicle from rolling. Place a dolly jack under differential housing and raise front end of vehicle high enough to permit withdrawing axle assembly. Place blocks under frame side rails at rear of front spring hanger brackets. Lower dolly jack until entire front end weight rests on blocks. Leave dolly jack raised high enough to support axle assembly.

c. **Remove Wheels.** Remove wheel stud nuts and remove wheel and tire assembly from each side.

d. **Disconnect Propeller Shaft.** Disconnect propeller shaft at differential. Tie propeller shaft up to prevent universal joint from becoming damaged or filled with dirt.

e. **Disconnect Drag Link.** Disconnect drag link at axle steering arm (par. 207).

f. **Disconnect Flexible Brake Hoses.** Turn off the front brake shut-off cock inside of right-hand frame side rail (fig. 185). Loosen connections at frame side rails, then remove hoses from wheel cylinders.

g. **Disassemble Spring to Axle Mounting.** The spring to axle mounting is slightly different on the two types of axles, therefore, this part of removal procedure is explained separately for each axle.

(1) **BANJO TYPE AXLE.** Remove nuts from U-bolts on both sides, remove shock absorber link bracket and spring bumper blocks, and remove U-bolts.

(2) **SPLIT TYPE AXLE.** Remove four nuts from spring bolts on left side and remove shock absorber link bracket and spring bumper block, and remove spring clip bolts. On right-hand side, remove four nuts from studs and remove shock absorber link bracket and spring bumper block. (The four studs will be removed from housing after axle assembly is withdrawn from under vehicle.)

h. **Remove Axle Assembly.** Lower dolly jack until axle assembly clears under side of chassis and withdraw from under vehicle. (On split type axles, remove the four studs from axle housing at right-hand spring seat.)

TRUCK, 2½-TON, 6 x 6

169. FRONT AXLE INSTALLATION.

a. The following procedures are applicable to both the banjo and split type axles, with exceptions noted in text.

b. **Position Axle Assembly.** (If axle to be installed is split type, install four studs in tapped holes in housing at right-hand spring seat.) Place axle assembly on dolly jack and move into position under vehicle. Raise axle assembly into position against springs, being certain spring center bolt heads enter alinement holes in axle spring seats.

c. **Assemble Spring to Axle Mounting.** This operation differs on the two types of axles, and will be described separately for each type.

(1) **BANJO TYPE AXLE.** Install U-bolts. U-bolts of three different lengths are used. The two shortest ones are used on the left-hand mounting and the remaining two are used on the right-hand mounting. The longer of the two on the right side is used on the inside, adjacent to the differential. Install spring bumper blocks and shock absorber link brackets on U-bolts, install nuts, and tighten to 170-185 foot-pounds.

(2) **SPLIT TYPE AXLE.** Install spring bolts, bolt guard, spring bumper block, and shock absorber link bracket on left-hand mounting and install nuts on spring clip bolts. The bolt guard at the bottom and the shock absorber link bracket at the top necessitates using the two longer bolts at the front. On right-hand mounting, install bumper block and shock absorber link bracket on studs and install nuts. Tighten nuts on both right- and left-hand mounting to 170-185 foot-pounds.

d. **Connect Propeller Shaft.** Connect propeller shaft at differential (par. 176).

e. **Connect Flexible Brake Hoses.** Install flexible hoses in wheel cylinders and tighten connections at frame side rails. Turn front brake shut-off cock on.

f. **Connect Drag Link.** Refer to paragraph 207 for instructions on installing and adjusting drag link on steering arm ball.

g. **Install Wheels.** Install wheel and tire assemblies on hubs, install wheel stud nuts, and tighten firmly.

h. **Remove Blocks and Dolly Jack.** Raise front of vehicle with dolly jack and remove blocks from under frame side rails. Lower dolly jack and withdraw from under vehicle. Check all nuts on spring mounting bolts for tightness with full weight of vehicle resting on springs.

i. **Bleed Brakes.** Bleed front wheel brakes (par. 180).

j. **Lubricate.** Check lubrication of complete axle assembly and propeller shaft universal joint as instructed in Section VIII. Check condition of filler plug gasket [(GM-344830) G85-31-05800] and replace if necessary.

Section XXXI

REAR AXLES

170. DESCRIPTION.

a. **Description.** The rear driving unit is a centrally supported unit consisting of two single-reduction, spiral-bevelled driving axles. Each axle is attached to the frame by three independent torque rods. Both driving and braking load is transferred directly to the chassis frame by these rods. Two types of axles are used, the banjo type and the split type (fig. 7). The split or two-piece type is so-called since the housing is made in two pieces, bolted together at the differential. The banjo type housing is of one-piece construction.

b. **Operation.** Power is transmitted from the transfer case to the forward rear (intermediate) axle by a single propeller shaft. Power to the rearward rear axle is transferred from the transfer case to a pillow block attached to the top of the forward rear (intermediate) axle, and thence to the rearward axle by another propeller shaft.

c. **Data.**

| Type | GM Number | |
|--|---------------------------|-----------|
| | Front (Intermediate) Unit | Rear Unit |
| Banjo Type (with conventional brake drums) . . . | 3665609 | 3665610 |
| Banjo Type (with demountable brake drums) . . . | 3678649 | 3678650 |
| Split Type | 2181204 | 2181205 |

171. AXLE SHAFT (BANJO TYPE AXLES).

a. **Description.** Axle shafts are full floating type with flanges forged at the outer ends. The axle shafts carry the driving force from the differential to the wheels. Flanges are attached to the hubs by

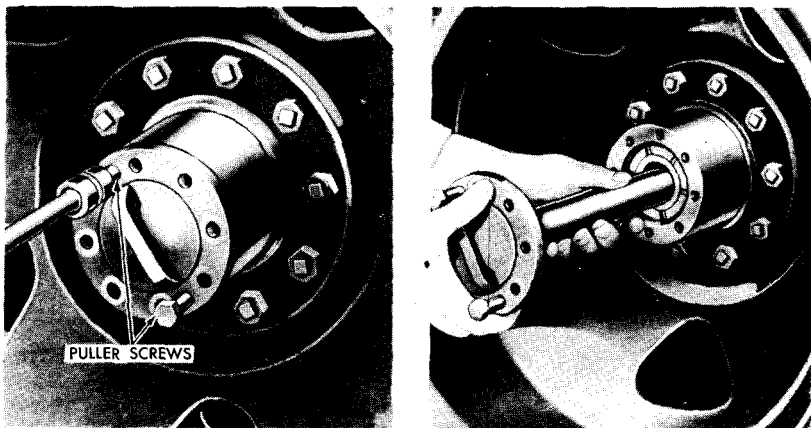

Figure 155—Removing Rear Axle Shaft (Banjo Type Axle) RA PD 64498

TRUCK, 2½-TON, 6 x 6

cap screws and the inner ends of the shafts are splined to the differential side gears.

b. **Removal.** Remove eight cap screws and lock washers attaching drive flange to hub. Using two of these cap screws as puller screws, thread them into the two tapped holes in flange (fig. 155). Pull shaft out by alternately turning in the two cap screws. Withdraw axle shafts from hub (fig. 155) and remove gasket [(GM 3660100) G85-31-06160].

c. **Installation.** Make sure axle shaft is clean. Slide gasket over end of shaft and hold in place on flange. Insert splined end of shaft through hub and guide splines into differential side gear. Aline holes in flange and hub and install eight cap screws with lock washers. Tighten cap screws alternately to 70-80 foot-pounds.

172. AXLE SHAFT (SPLIT TYPE AXLES).

a. **Description.** Axle shafts are full-floating type with flanges forged at the outer ends. The axle shafts carry the driving force from the differential to the wheels. Flanges are attached to the hubs by studs, nuts, and tapered dowels. Inner ends of the shafts are splined to the differential side gears.

b. **Removal** (fig. 156). Remove eight nuts and lock washers from flange to hub studs. Loosen puller screws and back lock nuts out to end of threads. Alternately turn puller screws in, pulling axle shaft and tapered dowels toward end of studs. Back puller screws out and drive axle shaft in until flange is against hub. Pull tapered dowels off studs. **NOTE: If tapered dowels are not loose, remove puller screws and remove lock nuts from screws. Install puller screws and again turn them in alternately to pull tapered dowels farther out toward end of studs. Drive axle shaft in and then remove dowels from studs.** Withdraw axle shaft from hub and remove two gaskets [(GM-2087553) G57-01-94022] and wheel bearing oil seal from studs.

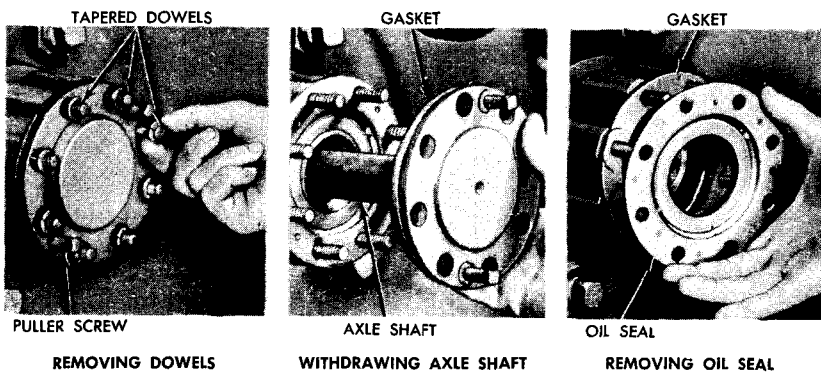
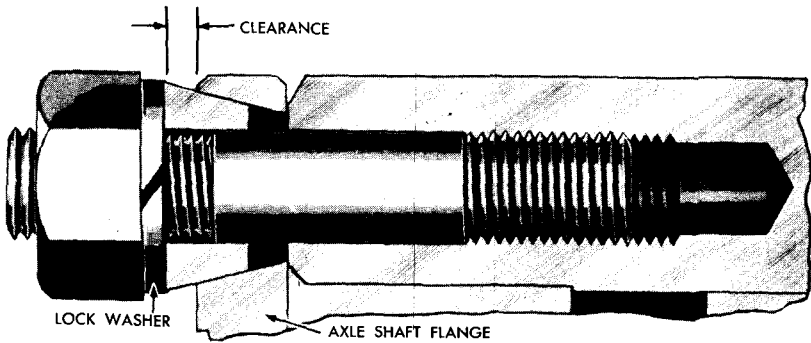

Figure 156—Rear Axle Shaft Removal (Split Type Axle)

RA PD 332896

REAR AXLES



RA PD 332909

**Figure 157—Axle Shaft Flange Dowel Clearance
(Split Type Axle)**

c. **Installation.** Inspect wheel bearing oil seal. Use a new seal if worn or damaged. Install gasket, oil seal, and another gasket on hub studs. Make sure axle shaft is clean and insert splined end of shaft through hub, guiding splines into differential side gear. **NOTE:** *Hub construction provides only two points against which the axle shaft puller screws may bear; axle shaft must be positioned with puller screws alined with these points.* Install tapered dowels on studs, and install nuts with lock washers. Tighten nuts alternately to 58-62 foot-pounds. Tapered dowels are split so they will compress around studs without bottoming against hub when nuts are tightened. There should be a slight clearance between lock washers and flange when nuts are tight (fig. 157). If there is no clearance, the studs, dowels, or holes in flange are worn excessively and new parts must be installed.

173. REAR AXLE REMOVAL.

a. **Preliminary Instructions.** The following procedure is applicable to either the banjo or split type axles, and to either the rearward or forward (intermediate) unit. Figure 158 shows items which must be disconnected prior to removing the rearward unit.

b. **Jack Up Rear End.** Place vehicle on a level surface and block front wheels. Place a jack under each trunnion cross shaft torque rod bracket (fig. 158), and jack up rear end. Place a dolly jack under unit to be removed and raise high enough to support unit.

c. **Remove Wheels.** Remove outer wheel nuts and remove outer wheel and tire assembly, then remove inner wheel nuts and remove inner wheel and tire assembly from each end of axle.

d. **Disconnect Brake Hose.** Loosen brake line connection at frame side rail, then unscrew flexible hose from wheel cylinder at brake flange plate (dust shield).

e. **Disconnect Propeller Shaft.** Disconnect propeller shaft at differential.

TRUCK, 2½-TON, 6 x 6

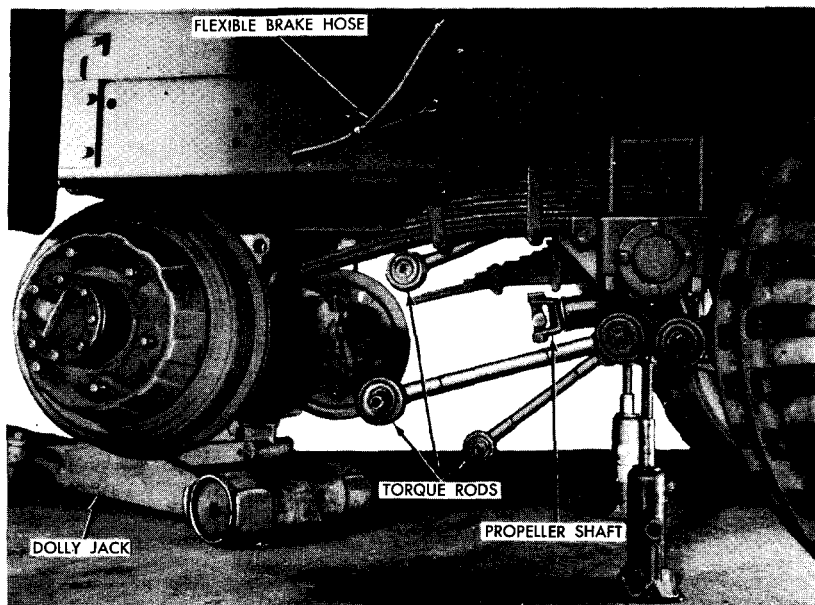

RA PD 332928

Figure 158—Rear Axle Removal (Banjo Type Shown)

f. **Remove Pillow Block (Forward Unit Only).** Remove four cap screws and lock washers attaching pillow block to bracket on axle housing and tie pillow block up to prevent it from dropping when axle is removed.

g. **Disconnect Torque Rods.** Disconnect torque rods as directed in paragraph 212.

h. **Withdraw Axle Assembly.** With axle resting on dolly jack, move forward or rearward as necessary until spring ends are free of guide brackets on axle housing and withdraw the axle assembly from under vehicle (fig. 158).

174. REAR AXLE INSTALLATION.

a. **Preliminary Instructions.** The following procedure is applicable to either the banjo or split type axles, and to either the rearward or forward (intermediate) unit. Figure 158 shows items which must be connected after axle is positioned under vehicle.

b. **Position Axle Assembly.** Place axle assembly on dolly jack and move into approximate position under vehicle (fig. 158). Move axle toward rear or front of vehicle as necessary, guiding spring ends into guide brackets on axle housing. Line up holes in torque rod brackets with torque rod end pins.

c. **Connect Torque Rods.** Connect torque rods as directed in paragraph 212.

REAR AXLES

- d. **Connect Propeller Shaft.** Connect propeller shaft at differential (par. 176).
- e. **Install Pillow Block (Forward Unit Only).** Attach pillow block to bracket on axle housing, using four cap screws and lock washers. Tighten cap screws firmly.
- f. **Connect Brake Hose.** Install flexible brake hose into wheel cylinder at brake flange plate (dust shield) on each end of axle and tighten snugly. Tighten brake line connections at frame side rails and bleed brakes (par. 180).
- g. **Install Wheels.** Place inner wheel and tire assemblies on hubs and install inner wheel nuts. Successively tighten opposite nuts to prevent cocking wheel on studs. Place outer wheel and tire assemblies on hubs with valve stems on opposite side of hub to the valve stems on the inner wheels. Install outer wheel nuts and tighten alternately.
- h. **Lubricate Axle and Remove Jacks.** Lubricate axle assembly and propeller shaft universal joints as directed in Section VIII. Lower jacks and remove from under vehicle.

Section XXXII

PROPELLER SHAFTS, UNIVERSAL JOINTS, AND PILLOW BLOCK

175. DESCRIPTION.

- a. **Propeller Shafts and Universal Joints** (fig. 159). Five propeller shafts and a pillow block transfer power from the transmission to the transfer case and three driving axles. Each shaft has a universal joint at each end to permit angular movement of shaft during rotation. Universal joint yoke is welded to shaft at one end and is splined to the shaft at the other end, forming a slip joint which permits telescopic action of shaft during operation.
- b. **Pillow Block** (fig. 161). Pillow block, mounted on top of forward rear (intermediate) axle housing, connects the two propeller shafts which transfer power from the transfer case to the rearward rear axle. The pillow block shaft is mounted on tapered roller bearings in the pillow block. Oil seals are used at each end of the pillow block to retain lubricant.

176. PROPELLER SHAFTS AND UNIVERSAL JOINTS.

- a. **General.** Propeller shafts are connected to their respective units either by two U-bolts or by four straight bolts, depending on the type of flange used. The following shafts are attached at both ends

TRUCK, 2 1/2-TON, 6 x 6

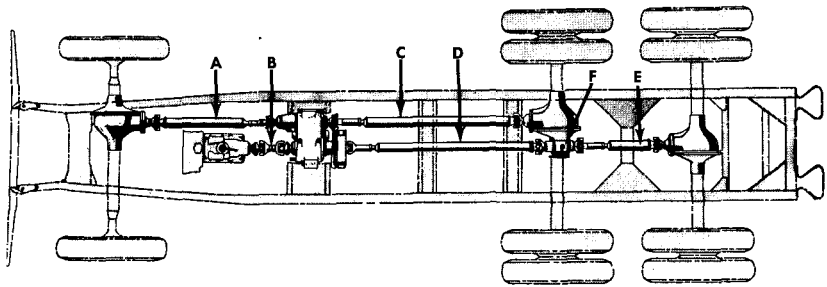

WITH SPLIT TYPE AXLE

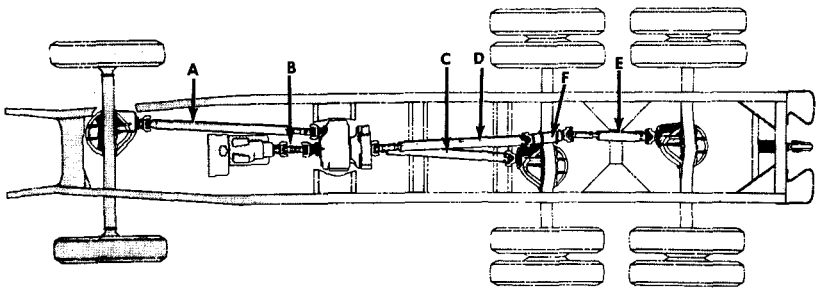

WITH BANJO TYPE AXLE

- | | |
|---|---|
| <p>A PROPELLER SHAFT TO FRONT AXLE B TRANSFER CASE TO TRANSMISSION PROPELLER SHAFT C TRANSFER CASE TO FORWARD REAR AXLE PROPELLER SHAFT</p> | <p>D TRANSFER CASE TO PILLOW BLOCK PROPELLER SHAFT E PILLOW BLOCK TO REARWARD REAR AXLE PROPELLER SHAFT F PILLOW BLOCK ASSEMBLY</p> |
|---|---|

RA PD 332923

Figure 159—Propeller Shaft Location

by U-bolts; transfer case to front axle; transfer case to forward rear (intermediate) axle; pillow block to rear axle. Transfer case to pillow block shaft is attached to the pillow block by U-bolts and to the transfer case by straight bolts. Transmission to transfer case shaft is attached at both ends by straight bolts. The slip joint and shaft are marked with arrows so that if the universal joint yoke is removed from the shaft, they may be reassembled in their original position with the universal joint yokes in the same plane.

b. Propeller Shaft Removal. Make certain arrows are visible (fig. 160); if not, punch mark both members so they may be reassembled in their original positions. Any shaft may be removed by disconnecting both ends as directed in step (1) or (2) below, whichever one may apply.

(1) **U-BOLT TYPE.** Remove four nuts and lock washers from U-bolts and remove U-bolts [(GM-2066840) G85-32-00500]. Shorten shaft by telescoping at slip joint and wrap tape around bearings and journal to prevent bearings dropping off.

PROPELLER SHAFTS, UNIVERSAL JOINTS, AND PILLOW BLOCK

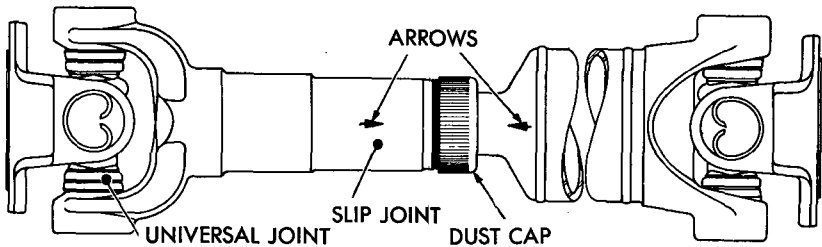

RA PD 64497

Figure 160—Universal Joint Alinement Marks

(2) **STRAIGHT BOLT TYPE.** Remove four nuts and lock washers from bolts attaching universal joint flange to transmission or transfer case. Remove bolts from companion flange on front or rear of transfer case [front—(GM-093420) G501-01-24271; rear—(GM-082069) G501-01-24270]. Separate flanges by telescoping shaft at slip joint.

c. **Propeller Shaft Installation.** Make sure that arrow (or marks made at removal) are alined (fig. 160). Position shaft with slip joint at input end and connect both ends as directed in step (1) or (2) below, whichever one may apply.

(1) **U-BOLT TYPE.** Remove tape or wrapping from bearings and journal. Make sure that bearings and journal are clean and the bearing needles are in place in bearings. Raise shaft into position and seat bearings in place in yoke. Install U-bolts around bearings and through yoke, install nuts and lock washers, and tighten snugly.

(2) **STRAIGHT BOLT TYPE.** Aline flanges and install four straight bolts. Install nuts and lock washers on bolts and tighten firmly.

177. **PILLOW BLOCK.**

a. **Check Adjustment.** Disconnect propeller shafts at each end of pillow block (par. 176 b (1)), and check pillow block shaft for end play. Shaft should spin freely in bearings and should not have more than a barely perceptible amount of end play. If end play is excessive, replace pillow block assembly.

b. **Removal (fig. 161).** NOTE: *If replacement unit is not equipped with flanges, the flanges must be removed from the old unit and installed on the replacement unit.*

(1) **REMOVE PILLOW BLOCK.** Disconnect propeller shafts at each end of pillow block (par. 176 b (1)). Tie propeller shafts up to prevent dirt from getting into bearings. Remove four cap screws and lock washers attaching pillow block to bracket on axle housing and lift pillow block from axle.

(2) **REMOVE FLANGES (IF NECESSARY).** Remove cotter pin, flange retaining nut, and washer from each end of pillow block shaft. Tap flanges off ends of shaft, using a soft metal hammer.

TRUCK, 2½-TON, 6 x 6

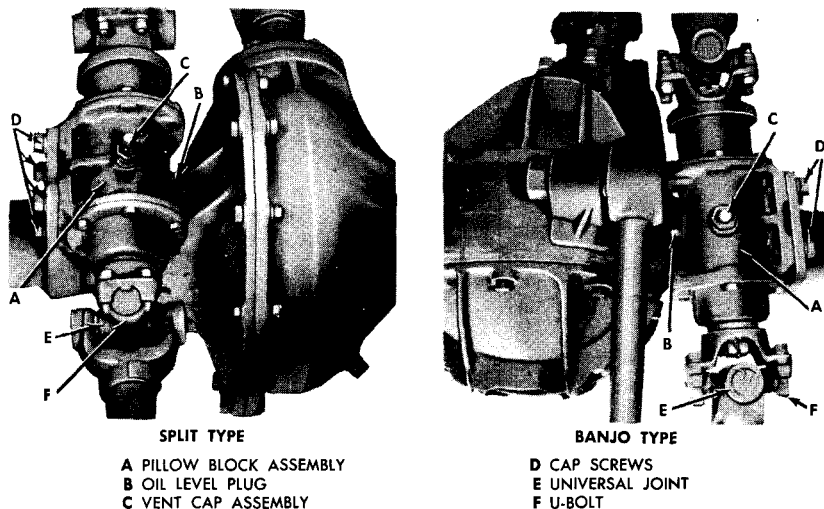

RA PD 332924

Figure 161—Pillow Block Installation

c. Installation (fig. 161).

(1) **LUBRICATION FITTING (LATE MODELS).** Pillow block assemblies on late model vehicles include a pressure fitting in place of the level plug (fig. 161). Whenever pillow block is removed for service purposes, the lubrication fitting can be installed in place of the level plug. Remove the filler plug and breather assembly, and level plug, then turn pillow block upside down, draining all lubricant. Turn shaft several times by hand and allow enough time for complete drainage. Reinstall filler plug and breather assembly in same location. Install 90 degree lubrication fitting in level plug location with end of fitting pointing toward front of vehicle and down approximately 15 degrees below horizontal position. Lubricate pillow block assembly with chassis grease as indicated in Section VIII.

(2) **INSTALL FLANGES (IF NECESSARY).** Loosen front and rear end cover cap screw. Seal surface on flange hub must be smooth and polished, and free of scores and nicks. Place key in keyway at each end of shaft. Install propeller shaft flange at each end of shaft, carefully sliding hub of flange through cover oil seal. Flange with dust shield must be installed on front end of shaft. Be certain outer portion of seal is not damaged or doubled back while installing the flange. Check depth of space between end of key and nut face of flange. If less than ⅜-inch deep, drive key in with punch to obtain this dimension. Apply aviation type permatex to end of new cork seal and force seal into keyway against end of key. Install tongued washer and flange nut on each end of shaft, tighten solidly, and lock in place with new cotter pin. With flange nuts tightened, the compressed cork will effectively seal the keyway. Tighten front and rear cover cap screws.

PROPELLER SHAFTS, UNIVERSAL JOINTS, AND PILLOW BLOCK

(3) **INSTALL PILLOW BLOCK** (fig. 161). Position pillow block at support bracket on axle housing, with dust slinger on pillow block toward front of vehicle. Install four bracket to pillow block cap screws and lock washers and tighten firmly. Connect propeller shafts at each end of pillow block (par 176 c (1)). Lubricate pillow block and universal joints as instructed in Section VIII.

Section XXXIII

SERVICE BRAKE SYSTEM

178. DESCRIPTION.

a. Description. The vacuum hydraulic operated service or foot brake system consists of an internal expanding type brake assembly comprising two brake shoe assemblies at each front wheel and at each inner wheel of the dual rear wheels. The system is comprised primarily of a manually operated foot pedal, interconnected to a hydraulic master cylinder to build up the initial hydraulic pressure; a Hydrovac power unit with related parts to increase initial hydraulic pressure as required; interconnecting hydraulic lines and fittings; and a hydraulic wheel cylinder to operate the mechanical brake shoe assembly at each wheel (fig. 162).

b. Operation. The operation of service brakes depends upon two elements: hydraulic fluid pressure and vacuum. The arrangement and mechanism of the component parts of system are such that both the hydraulic and vacuum principals must operate in conjunction with each other to finally apply brakes efficiently. The service brakes are operated simultaneously at all wheels by the manual application of the foot brake pedal.

(a) **Application.** The manually operated pedal, interconnected to the piston rod of the hydraulic master cylinder, forces the brake fluid under pressure from the master cylinder through pipe lines into the mechanism of Hydrovac unit, then into each wheel cylinder. When this initial pressure reaches a predetermined amount, the pressure operates the relay valve mechanism in the Hydrovac unit. The mechanism then cuts off the vacuum and admits atmospheric pressure to one side of the pistons in the power cylinder. Action of the pistons, interconnected to slave cylinder piston, then increases the hydraulic pressure to all wheel cylinders.

(b) **Release.** Upon release of the foot pressure at the brake pedal, initial line pressure is relieved. This decreased pressure permits the relay valve mechanism in the Hydrovac unit to close off the atmospheric pressure and open the vacuum port into the cylinders. Engine manifold vacuum creates vacuum on both sides of the Hydrovac pistons, thus permitting the spring to return the

TRUCK, 2½-TON, 6 x 6

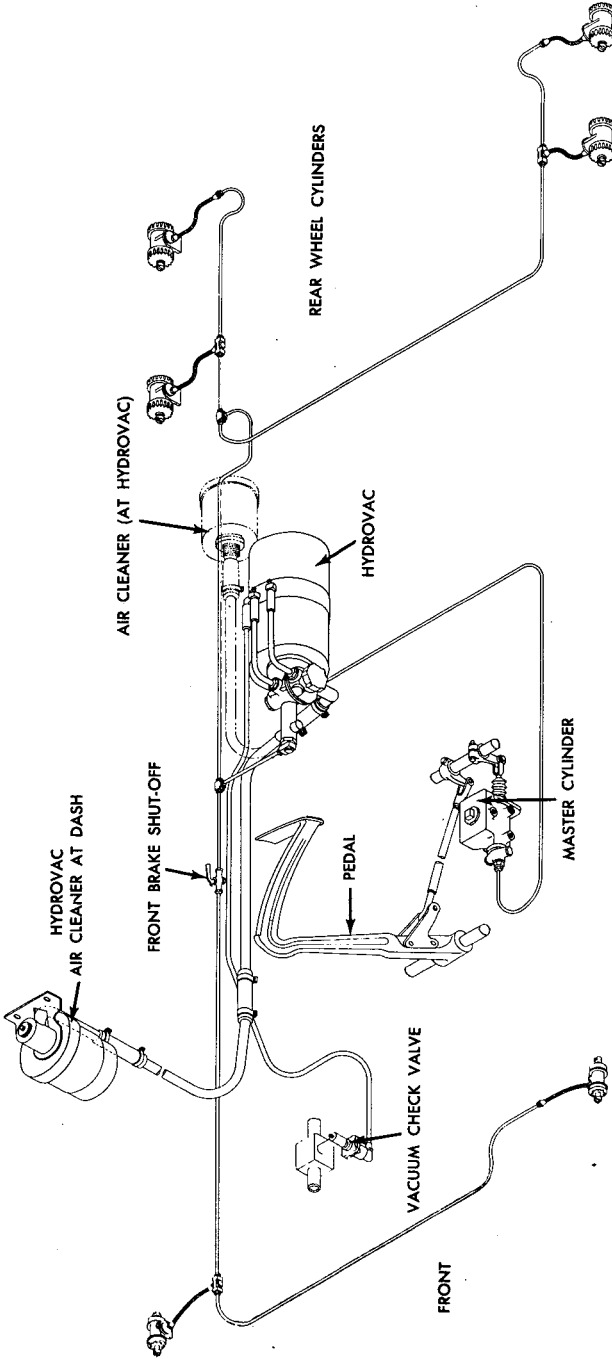

RA PD 332788

Figure 162—Service Brake System

SERVICE BRAKE SYSTEM

pistons to the released or off position. The brake shoe return springs can then return the brake shoes and the wheel cylinders into the released position, forcing the fluid from the wheel cylinders through the lines and the Hydrovac back into the hydraulic master cylinder reservoir.

179. SYSTEM TESTS.

a. **General.** There are several tests which may be applied to the service brake system, results of which will indicate the condition of the various units in the system. Generally, the performance of the brakes, together with a few simple tests, will indicate the condition of the power unit; however, in order to correctly diagnose specific deficiencies, vacuum and pressure gages should be used as indicated in the following subparagraphs.

b. **System Performance Tests.** The following tests should be made at regular intervals to check the general performance of the brakes:

(1) **WITH ENGINE RUNNING.**

(a) Start the engine and allow it to idle for about 10 seconds.

(b) Depress brake pedal with about as much foot pressure as required for normal stopping. Note the approximate position of the pedal pad and the foot pressure required to hold it in this position. Measure distance between pedal pad and toe board for further check as described in (2) below.

(c) Remove foot from pedal and turn off ignition switch.

(2) **WITH ENGINE STOPPED.**

(a) Depress brake pedal five times to approximately the same position as noted in step (1) (b) above.

(b) If the pressure required to push the pedal to this position during the fifth application is noticeably greater than in step (1) (b) above, the vacuum system is operating satisfactorily. If pressure is not greater, further tests should be made.

(c) **NOTE:** *Generally, an increase in required foot pressure will be noted upon each of the five applications as compared to the application immediately preceding it. This is because the system vacuum is being depleted during each application while the engine is not running.*

(d) After the vacuum in the system has been completely depleted, depress brake pedal and hold foot pressure. If the pedal gradually "falls away" under foot pressure, the hydraulic brake system is leaking and an immediate check and correction must be made.

(e) If the brake pedal travels to within two inches of the floor board, there is not enough brake pedal reserve and a brake shoe adjustment is required.

(3) **ROAD TEST.** Road test the vehicle by making a brake application at about 20 miles per hour, noting whether the vehicle stops evenly and quickly.

(a) If the brake pedal has a spongy feel when the brakes are applied, there is air in the hydraulic system. Bleed the system.

TRUCK, 2½-TON, 6 x 6

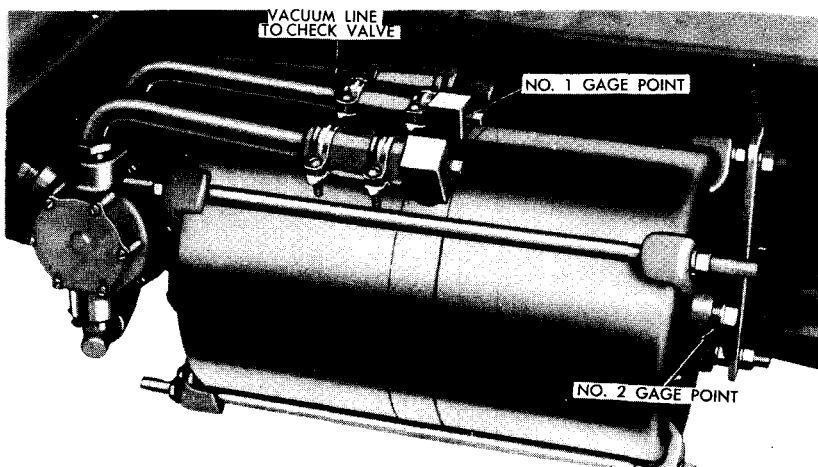

RA PD 332992

Figure 163—Hydrovac Vacuum Leak Tests

(b) If the brakes operate satisfactorily when tested at temperature above freezing, but are ineffective and do not release properly at temperatures below freezing, report this condition to higher authority, as water may have entered the vacuum system where it may later cause more serious difficulty.

c. **Vacuum Tests** (fig. 163). Vacuum test must be made with two vacuum gages (41-G-500). Gage, which will be termed as *No. 1*, must be installed in the Hydrovac center plate center elbow. It is necessary to remove the pipe plug from this elbow for the installation. Gage, which will be termed as *No. 2*, must be installed in place of the pipe plug at the back end of the rear cylinder shell.

(1) **VACUUM TEST (BRAKES RELEASED).**

(a) Start the engine and leave the brake pedal in released position. Note vacuum reading on *both* vacuum gages. They should register engine manifold vacuum (at least 14 in.), and should be exactly alike. If the reading is below manifold vacuum, a leak exists in the Hydrovac unit or in the lines from the intake manifold vacuum check valve.

(b) Stop the engine and remove the gage from the Hydrovac center plate elbow (No. 1) and reinstall the plug. Remove the vacuum line from the center plate elbow next to frame side rail, and connect the gage to the vacuum line. Start the engine and note the reading on the gage. If the gage does not register manifold vacuum (at least 14 in.), the leak is in the manifold vacuum check valve or lines. Check the lines from the Hydrovac unit to the manifold check valve for loose connections, etc. If the correction of loose connections in the lines does not remedy the leak, remove the pipe connection from the vacuum check valve at the valve. Install gage and start engine. Allow the engine to idle about 10 seconds, then turn off the

SERVICE BRAKE SYSTEM

ignition switch. If the gage reading decreases more than one inch of vacuum in 15 seconds, replace the check valve.

(c) After repairing or replacing manifold check valve or vacuum lines, reinstall gage No. 1 in the Hydrovac center plate center elbow. Reconnect the vacuum line to the elbow (next to side rail) and repeat test as described in step (a) above.

(d) If gages still register less than manifold vacuum, the leak exists in the Hydrovac unit, which must be replaced (par. 188).

(2) **VACUUM TEST (BRAKES APPLIED).**

(a) If, with the engine running and brake pedal released, both gages register manifold vacuum, depress the brake pedal and hold in the applied position. Note the reading of both gages. Gage No. 1 (on Hydrovac center plate elbow) should continue to register manifold vacuum, while gage No. 2 (at back end of rear cylinder shell) should drop to zero or, if a combination vacuum and pressure gage is used, to atmospheric pressure.

(b) If gage No. 1 (on Hydrovac center plate elbow) does not continue to register manifold vacuum, replace the Hydrovac unit (par. 188).

d. Hydraulic Pressure Test. These tests may be made to determine whether or not the correct hydraulic pressure is attained. The tests require the use of a hydraulic pressure gage registering at least 1200 pounds, in addition to a vacuum gage (41-G-500). Pressure gage must be installed in bleeder hole of a wheel cylinder. If a pressure gage is not available, vacuum leakage tests as described in subparagraphs c (1) and (2) above will generally indicate which unit, Hydrovac or check valve, is defective.

(1) If proper readings of manifold vacuum and atmospheric pressure are registered on gages No. 1 and 2, with the brake pedal depressed (subpar. c (2) above), the following test should be performed to check for hydraulic fluid leaks or deficient Hydrovac unit.

(2) Stop the engine and depress the brake pedal several times to deplete the vacuum in the Hydrovac, then depress the brake pedal again and note the reading on the hydraulic pressure gage at the wheel cylinder.

(3) Start the engine and depress the brake pedal again, noting pressure gage reading. If the reading is not double the pressure reading with the engine stopped, a leak in the hydraulic system is indicated. Hold the pedal in applied position for a few minutes and note the pressure reading at various intervals. The hydraulic pressure should not drop quickly and should not drop below the reading attained at the time of brake application.

(4) A low reading or a drop of hydraulic pressure indicates a leak either in the Hydrovac slave cylinder, or in the brake lines or wheel cylinders.

(5) Inspect each brake line and wheel cylinder separately and replace all worn or damaged parts. Repeat the tests described in steps (2) and (3) above. If the hydraulic pressure is still too low or drops too rapidly, a leak at the Hydrovac slave cylinder is indicated. Replace Hydrovac unit (par. 188).

TRUCK, 2½-TON, 6 x 6

180. BLEEDING SYSTEM.

a. The hydraulic lines must be bled to expel the air which may have entered the lines in the event any of the hydraulic lines connections have been broken or disconnected. The need of bleeding the system is generally indicated by a springy, spongy pedal action.

b. **Equipment.** System can be bled manually or with a pressure tank. When the manual system is used, two persons are needed to accomplish the operations; one to maintain a constant supply of fluid in the master cylinder reservoir and to pump the brake pedal, the other to accomplish bleeding operations at the Hydrovac unit and the wheel cylinders. If a conventional pressure tank is used, the tank may be connected to the hydraulic master cylinder, maintaining a constant supply of fluid in the reservoir, and sufficient air pressure to force the fluid through the lines to expel air at the bleeding points.

(1) **CONNECT PRESSURE TANK TO MASTER CYLINDER.** If pressure tank is used, connect tank hose with proper size adapter to the master cylinder filler cap aperture. The pressure tank should contain



HYDROVAC BLEEDING POINTS AND SEQUENCE

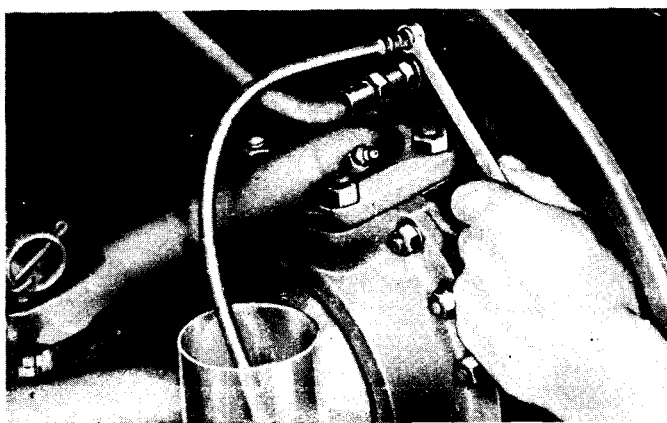

BLEEDING A WHEEL CYLINDER

Figure 164—Brake System Bleeding Points

RA PD 332862

SERVICE BRAKE SYSTEM

between 10 - 20 pounds air pressure and sufficient fluid to maintain constant fluid level in the master cylinder.

(2) **BLEED HYDROVAC.** The Hydrovac unit must be bled before bleeding the wheel cylinders and must be bled in correct sequence. Refer to figure 164 and bleed the Hydrovac at the bleeding screws in the sequence marked 1 and 2. It is not necessary to bleed the screw located on top of the slave cylinder directly above the inlet line connection. Remove bleeder cap screw and washer at each bleeder screw. Install bleeder tube (41-T-4170) in end of No. 1 bleeder screw. Place opposite end of bleeder tube in a suitable container with sufficient fluid to cover end of tube. While pumping brake pedal or with the use of air pressure in pressure tank, open bleeder screw three-quarters of a turn counterclockwise and observe flow of fluid at end of bleeder hose. Close bleeder screw firmly as soon as air bubbles stop and fluid comes out of tube in a solid stream. Repeat this operation on bleeder screw No. 2, making certain that hydraulic master cylinder has been replenished with fluid if manual system is used.

(3) **BLEED WHEEL CYLINDER.** Remove cap screw from wheel cylinder at backing plate and connect bleeder hose. Place the other end in a container with sufficient fluid to cover end of hose. While pumping with pedal or using pressure tank, open bleeder valve by turning three-quarters of a turn in counterclockwise direction. Close bleeder valve tightly as soon as air bubbles stop and fluid comes out in a solid stream. Repeat these operations on each wheel cylinder at the other brakes, replenishing fluid in hydraulic cylinder before each wheel cylinder is bled if using the manual system.

181. BRAKE SYSTEM ADJUSTMENTS FOR NORMAL WEAR.

a. **General.** Brake system adjustments necessary to compensate for normal wear are commonly confined to adjustments at the brake shoes. Other system adjustments such as brake pedal to toe board clearance and hydraulic master cylinder linkage adjustment are, as a general rule, not required to compensate for normal wear. These linkage adjustments are only necessary if linkage has been replaced or distorted as the result of collision, etc.

b. **Front Brake Shoe Adjustment (fig. 165).** Always check hub bearing adjustment (par. 199). A satisfactory brake adjustment cannot be obtained unless the hub bearings are in proper adjustment.

(1) **ON BANJO TYPE AXLES ONLY.** Remove two adjusting hole covers on backing plate, one at each side of hydraulic flexible line connection. Insert screw driver through hole in plate until screw driver engages notches on wheel cylinder adjusting cap (fig. 165). Turn adjusting cap in clockwise direction (when looking at end of cylinder) until there is a slight drag as wheel is turned by hand. Back off adjusting cap four notches to provide running clearance between brake lining and brake drum. Repeat this procedure at rearward shoe. Make adjustment at both front wheels, and make

TRUCK, 2½-TON, 6 x 6

certain that brake shoe adjustments on both wheels are as uniform as possible.

(2) ON SPLIT TYPE AXLES ONLY. Adjust by turning adjusting cam on forward shoe in direction as indicated by arrows in figure 165 until brake drags slightly when wheel is revolved by hand. Back off adjusting cam just enough to allow wheel to revolve freely. Repeat this procedure at rearward shoe. Both adjustments at each wheel should be as uniform as possible. In rare instances, this man-

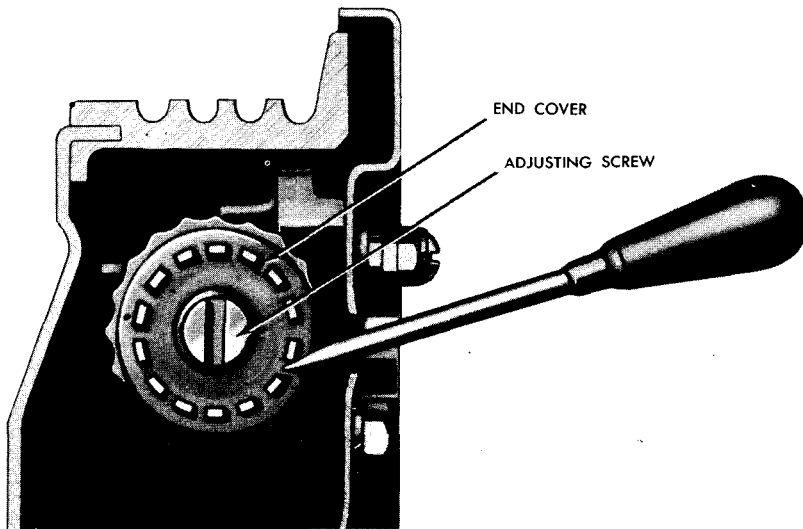

FRONT BRAKE SHOE ADJUSTMENT (BANJO TYPE AXLE)

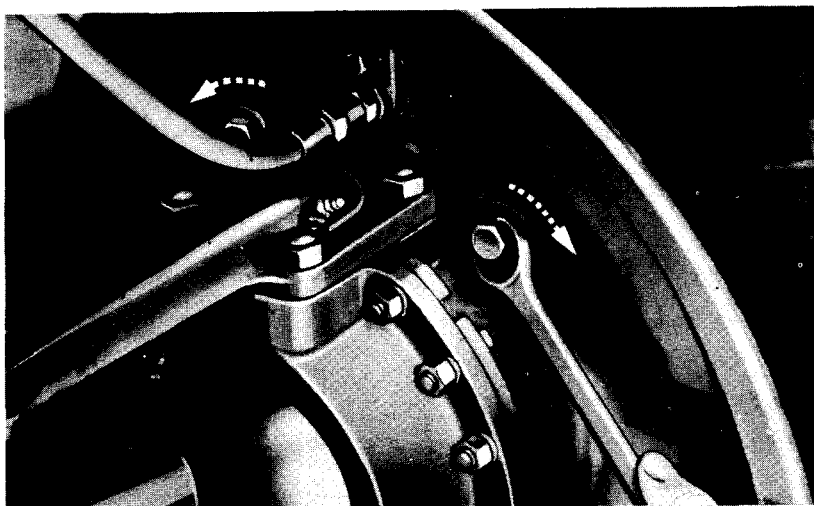

FRONT BRAKE SHOE MINOR ADJUSTMENT (SPLIT TYPE AXLE)

RA PD 332987

Figure 165—Front Brake Shoe Adjustment for Normal Wear

SERVICE BRAKE SYSTEM

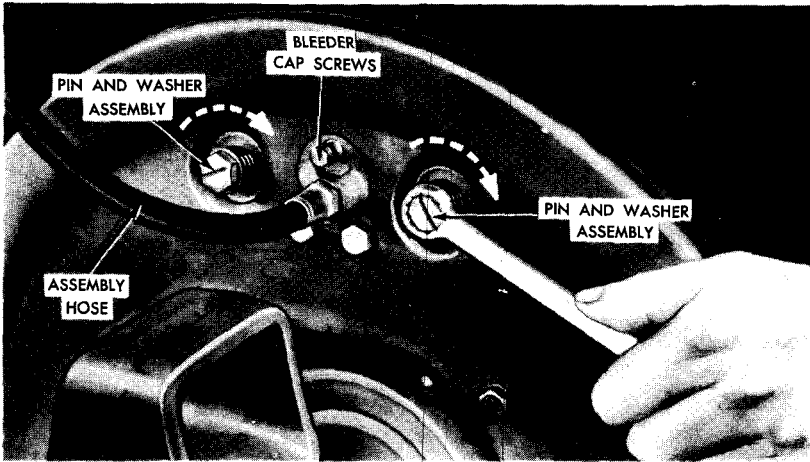

RA PD 16043

Figure 166—Rear Brake Shoe Adjustment for Normal Wear

ner of adjustment may not give entirely satisfactory results. In such instances, a *major adjustment* must also be made as described in paragraph 183.

c. **Rear Brake Shoe Adjustment.** Rear brake shoes are adjusted the same on both split and banjo type axles. Install wrench on hex head of one adjusting pinion shaft. Turn adjuster in clockwise direction as indicated by arrows on figure 166 until there is a slight drag as wheel is revolved by hand. Back off adjuster three-quarters of a turn, which will provide proper running clearance between brake lining and brake drum. Repeat the procedure on the opposite adjuster. Make certain that all brake shoes on each axle are adjusted as uniformly as possible.

182. FRONT BRAKE SHOES (WITH BANJO TYPE AXLE).

a. **Description** (fig. 167). The shoe assemblies are connected to an anchor plate with articulating links and an anchor pin. Guide plates, riveted to the anchor plate near the upper ends of the shoes, hold each shoe in the proper alinement. The upper end of each shoe rests in slotted adjusting studs threaded into wheel cylinder caps. On vehicles equipped with demountable brake drums only, the drum must be removed to gain access to shoe assemblies. The hub, drum, and bearings must be removed on vehicles equipped with conventional drums.

b. **Shoe Assembly Removal.** Jack up front wheel to be serviced. Remove wheel. On vehicles equipped with demountable drums, remove drum (par. 185). On other vehicles, remove hub, drum, and bearings (par. 201).

(1) **DISCONNECT SHOE LINKAGE** (fig. 168). Install wheel cylinder clamp (41-C-1835) over ends of wheel cylinder. Remove return spring [(GM-2030574) G85-11-02130] with pliers (41-P-

TRUCK, 2 1/2-TON, 6 x 6

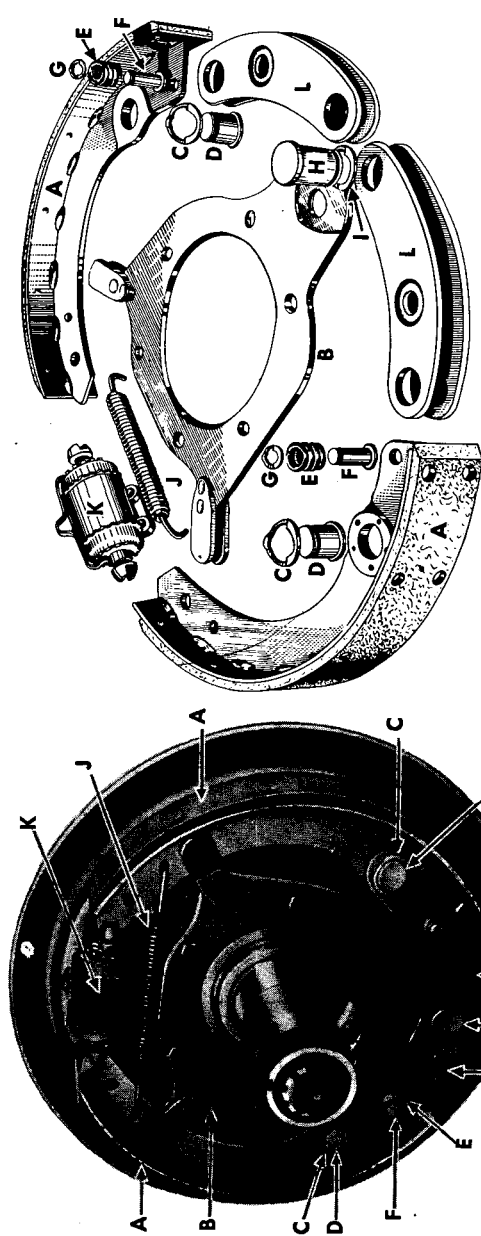

- A BRAKE SHOE AND LINING
- B FRONT BRAKE SHOE ANCHOR PLATE ASSEMBLY
- C FRONT BRAKE SHOE LINK PIN LOCK
- D FRONT BRAKE SHOE LINK PIN
- E PIN SPRING
- F PIN
- G PIN LOCK
- H ANCHOR PIN
- I ANCHOR PIN LOCK
- J FRONT BRAKE SHOE RETURN SPRING
- K FRONT BRAKE SHOE WHEEL CYLINDER
- L FRONT BRAKE SHOE LINK

Figure 167—Front Brake Shoe Assembly—Banjo Type Axle

RA PD 307476

SERVICE BRAKE SYSTEM

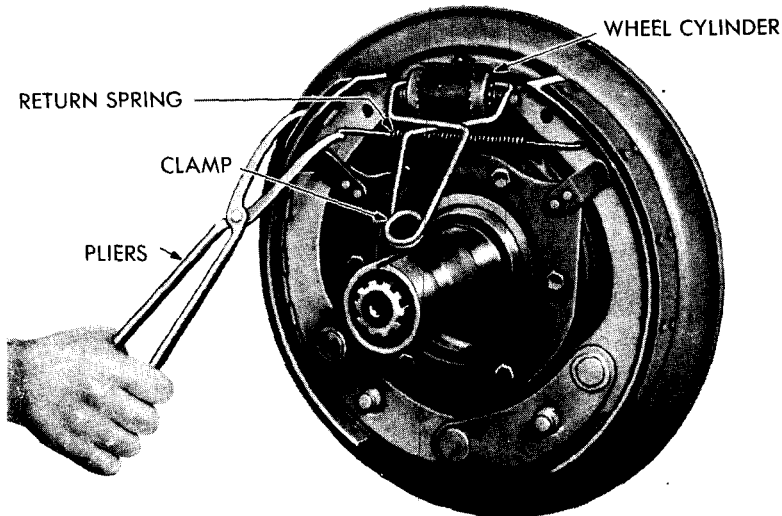

RA PD 332845

Figure 168—Method of Clamping Wheel Cylinder and Removing Spring (Clamp 41-C-1835 and Pliers 41-P-1579)

1579). Remove anchor pin lock with screw driver, then remove anchor pin.

(2) **REMOVE SHOES.** Brake shoes [(GM-3660054) G85-31-13220] with the links attached, can be removed by swinging them clear of guides on anchor plate. Remove friction pin lock, pins, and springs. Remove link pin locks and pins.

c. Brake Shoe Assembly Installation.

(1) **INSTALL LINKS TO SHOES.** Install brake shoe links to forward and reverse shoes. Links on reverse shoe are wider at anchor end than at shoe end. Install brake shoe link pin and lock. Install friction pin, springs, and new lock.

(2) **POSITION SHOES.** Position forward and reverse shoes between guide plates on anchor plate assembly. Check fit of shoes in guides. Shoes should be free without excessive side movement. Attach links to anchor plate with anchor pin and pin lock. Attach one end of return spring to one shoe, then with pliers (41-P-1579), attach other end to opposite shoe. Remove wheel cylinder clamp.

(3) **INSTALL BRAKE DRUM.** On vehicles with conventional type brake drums, install hub, drums, and bearings, then adjust the wheel bearings (par. 199). On vehicles equipped with demountable drums, install drums as described in paragraph 185.

(4) **ADJUST.** Install wheel, then adjust brake shoes as described in paragraph 181.

TRUCK, 2½-TON, 6 x 6

RA PD 316906

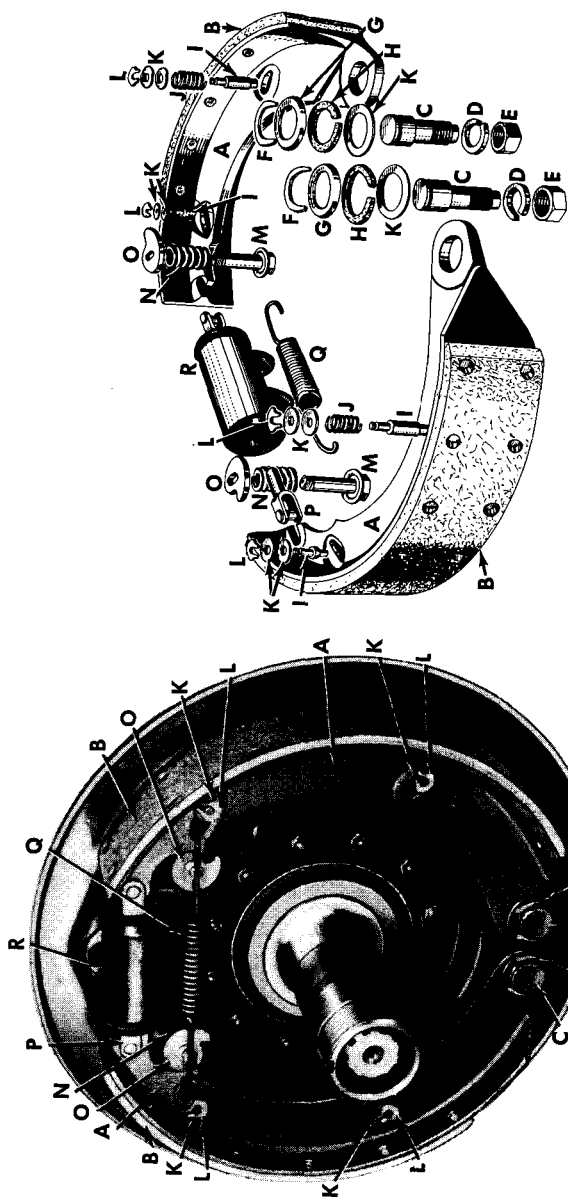

- J GUIDE PIN SPRING
- K PLAIN WASHER
- L "C" WASHER
- M ADJUSTING CAM
- N PIN SPRING
- O ADJUSTING CAM
- P YOKE
- Q RETURN SPRING
- R WHEEL CYLINDER

- A BRAKE SHOE AND LINING
- B BRAKE LINING
- C ANCHOR PIN
- D LOCK WASHER
- E NUT
- F ANCHOR PIN LOCK
- G RETAINER
- H FELT WASHER
- I GUIDE PIN

Figure 169—Front Brake Shoe Assembly—Split Type Axle

SERVICE BRAKE SYSTEM

183. FRONT BRAKE SHOES (WITH SPLIT TYPE AXLE).

a. **Description** (fig. 169). The brake shoes are anchored to the backing plate by adjustable eccentric pins at lower ends of the shoes. Adjusting cams, located near the upper ends of the shoes, bear against the brake shoes. Guide pins, two in each shoe, are riveted to the backing plate. Special washers used over pins are used on each side of the shoes and are held in place with C-washers which fit into the grooves at outer ends of the guide pins. C-washers are also used to hold the brake shoes in place on anchor pins. On vehicles equipped with split type axles, demountable brake drums are used.

b. **Shoe Assembly Removal.** Jack up front wheel to be serviced. Remove wheel, then remove demountable drum (par. 185).

(1) **DISCONNECT SHOE LINKAGE.** Install clamp (41-C-1835) over ends of wheel cylinder. Remove C-washers from anchor pins, using a 3/4-inch end wrench and hammer in manner shown in figure 170. It is not necessary to remove the anchor pins. With pliers, remove guide pin lock on both shoes (fig. 171).

(2) **REMOVE SHOES.** With pliers (41-P-1579), remove return spring [(GM-2030574) G85-11-02130]. Pull each shoe away from wheel cylinder yoke, then pull shoes [(GM-2030568) G508-03-84922 forward and (GM-2030569) G508-03-84923 reverse] straight out to remove from anchor pins at bottom and guide pins midway on shoes.

c. **Shoe Assembly Installation.**

(1) **POSITION BRAKE SHOES.** Position brake shoes over anchor pins and guide pins. Install a flat washer over each guide pin before installing brake shoes. Make certain that wheel cylinder yokes are positioned in upper end of brake shoes properly.

(2) **INSTALL BRAKE SHOE RETURN SPRING.** Install one end of

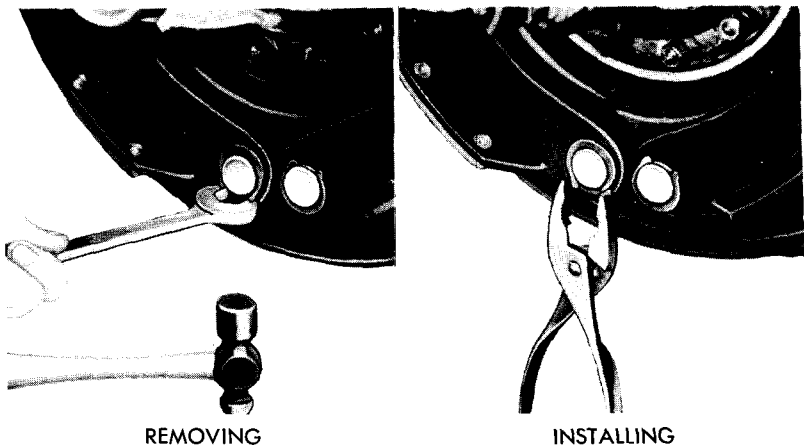
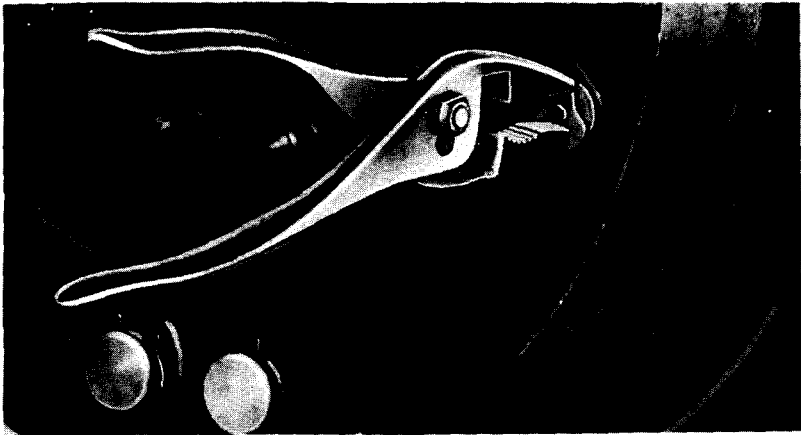

Figure 170—Removal and Installation of Anchor Pin Washers (Front Split Type Axle)

RA PD 64539

TRUCK, 2½-TON, 6 x 6



REMOVING

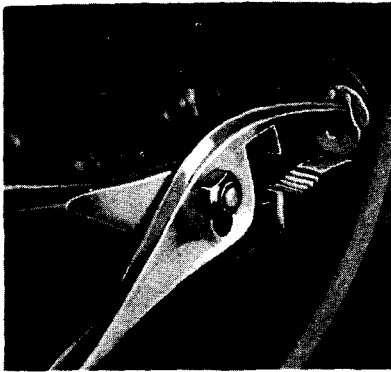

INSTALLING

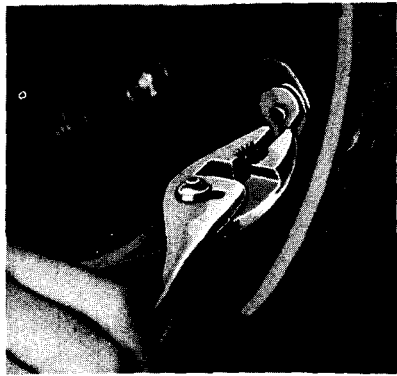

CLAMPING

Figure 171—Removing, Installing, and Clamping Guide Pin Locks (Front Split Type Axle)

RA PD 332914

spring in brake shoe, then with pliers (41-P-1579), install other end of spring in other brake shoe. After return spring is installed, remove wheel cylinder clamp (41-C-1835) from wheel cylinder.

(3) **INSTALL C-WASHERS IN GUIDE AND ANCHOR PINS.** Install flat washers over guide pins, then install C-washers on guide pins (fig. 171), making certain that C-washers seat solidly and are locked securely. Install C-washers on anchor pins. Tap washer into place firmly, then lock C-washers securely (fig. 171). Turn anchor pins until marks on pins are toward each other (fig. 172). Install drum (par. 185) and wheel.

d. Major Shoe Adjustment.

(1) **ADJUST FORWARD SHOE LINING CLEARANCE AT BOTTOM** (fig. 172). Remove inspection cover on front of brake drum. Revolve

SERVICE BRAKE SYSTEM

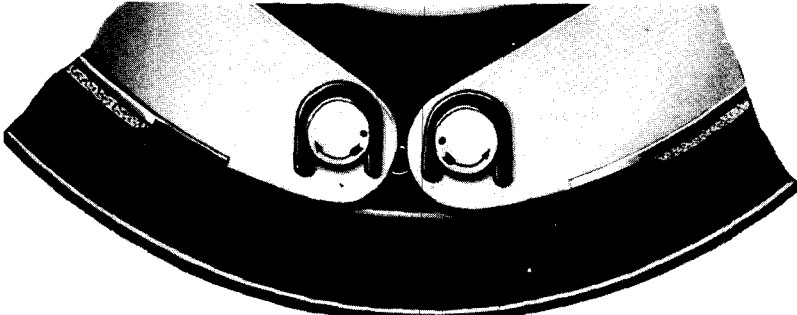

ANCHOR PIN POSITION



LINING CLEARANCE CHECK

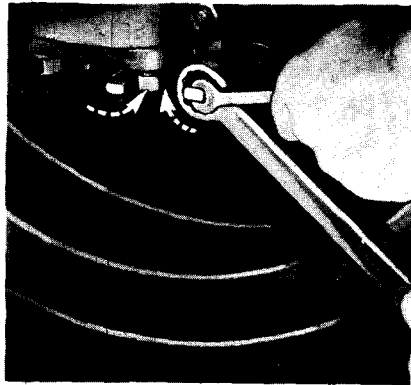

MAJOR ADJUSTMENT

RA PD 332852

Figure 172—Position of Anchor Pin and Major Adjustment

drum until opening is about $1\frac{1}{2}$ inches from end of forward brake shoe. Insert 0.010 inch feeler gage between drum and bottom or heel of shoe. Back off lock nut on anchor pin, using two wrenches, one on lock nut and the other on anchor pin. Turn anchor pin in direction shown in figure 172 until clearance of 0.010 inch is obtained.

(2) **ADJUST FORWARD SHOE LINING CLEARANCE AT TOP.** Revolve drum until opening is about $1\frac{1}{2}$ inches from end of lining at top or toe of shoe. Insert 0.020 inch feeler gage and turn anchor pin until that clearance is obtained. Recheck lower clearance.

(3) **ADJUST LINING CLEARANCE AT REVERSE SHOES.** Repeat steps (1) and (2) above on reverse shoe. Make certain that adjustments at both shoes are approximately the same. Tighten anchor pin lock nuts and check all clearances again.

(4) **ADJUST SHOES AT CAM.** Adjust shoes at cams as described in paragraph 181. Install wheel. Install inspection cover on brake drum.

TRUCK, 2 1/2-TON, 6 x 6

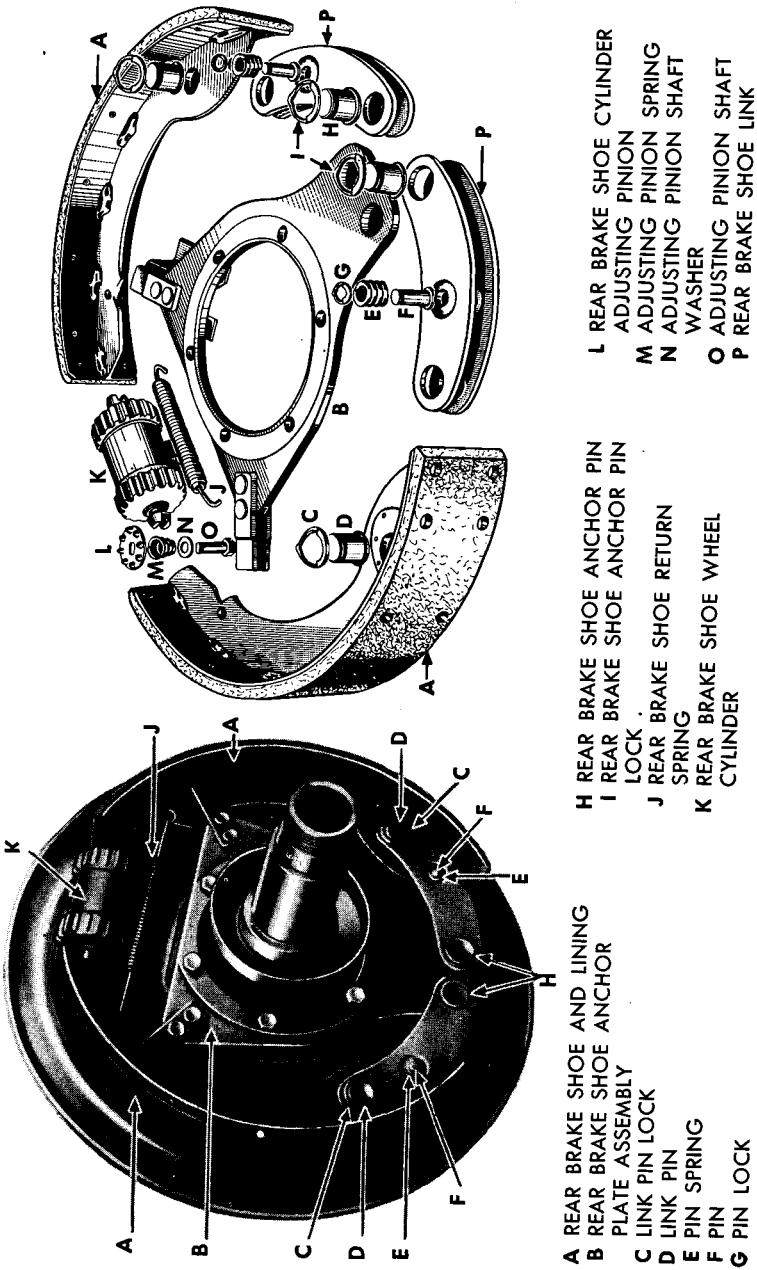

- A REAR BRAKE SHOE AND LINING
- B REAR BRAKE SHOE ANCHOR PLATE ASSEMBLY
- C LINK PIN LOCK
- D LINK PIN
- E PIN SPRING
- F PIN LOCK
- G PIN LOCK
- H REAR BRAKE SHOE ANCHOR PIN LOCK
- I REAR BRAKE SHOE ANCHOR PIN
- J REAR BRAKE SHOE RETURN SPRING
- K REAR BRAKE SHOE WHEEL CYLINDER
- L REAR BRAKE SHOE CYLINDER
- M ADJUSTING PINION
- N ADJUSTING PINION SPRING
- O ADJUSTING PINION SHAFT WASHER
- P REAR BRAKE SHOE LINK

Figure 173—Rear Brake Shoe Assembly

RA PD 307477

SERVICE BRAKE SYSTEM**184. REAR BRAKE SHOES.**

a. **Description** (fig. 173). The rear brake shoe assemblies on both split and banjo type axles are two-shoe type and are similar in construction. The shoes are anchored to the anchor plate through articulating links and two anchor pins located at the bottom of the anchor plate. The guide plates, riveted to the anchor plates near the upper ends of the shoes, hold each brake shoe in the proper alignment. The upper end of each brake shoe rests in a slotted adjusting stud threaded in the end caps of the wheel cylinder. Vehicles with banjo type axles are equipped with either demountable or conventional (non-demountable) type brake drums, while vehicles with split type axles are equipped with demountable type drums only.

b. Brake Shoe Assembly Removal.

(1) **REMOVE BRAKE DRUM, OR HUB AND DRUM.** Remove wheel. On vehicles equipped with demountable type drums, remove drum (par. 185). On other vehicles, remove hub, drum, and bearings (par. 201).

(2) **DISCONNECT SHOE LINKAGE.** Install clamp (41-C-1835) over wheel cylinder. Remove return spring with pliers (41-P-1579). Remove anchor pin locks (fig. 174), then remove pins. Brake shoes [(GM-3660048) G85-31-13240] with links attached, may then be swung clear of guide plates.

(3) **REMOVE LINKS AND FRICTION PINS.** Remove link pin lock and pin from each shoe. Remove friction pin lock, spring, and pin from each shoe.

c. Brake Shoe Assembly Installation.

(1) **INSTALL LINKS ON SHOES.** Install links to both shoes by installing link pin and lock, and friction pin, spring, and lock on each shoe. Use new locks, if available.

(2) **INSTALL SHOES.** Position shoes in place at guide plates. Install anchor pins and locks. Use new locks and make sure that locks fit in grooves of pins. With pliers (41-P-1579), install return spring, then remove clamp (41-C-1835).

(3) **INSTALL DRUM, OR HUB AND DRUM.** If demountable drum

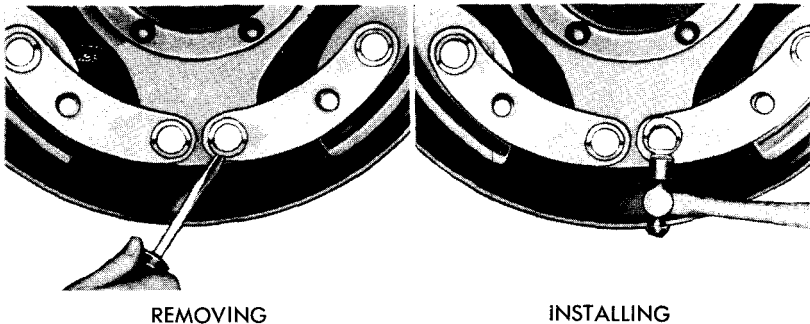

Figure 174—Removing and Installing Anchor Pin Locks

RA PD 64589

TRUCK, 2½-TON, 6 x 6

is used, install as described in paragraph 185. On other vehicles, install hub, drum, and bearings, then adjust wheel bearings (par. 199).

- (4) ADJUST. Adjust brake shoes (par. 181).

185. BRAKE DRUMS.

a. **With Banjo Type Axles.** Front and rear brake drums on banjo type axles are either the demountable type or conventional (non-demountable) type. The demountable type may be removed from the hub without the necessity of removing the complete hub and drum assembly. The non-demountable type drum is attached to the hub with serrated bolts and cannot be replaced until hub, drum, and bearings are removed.

- (1) DRUM REPLACEMENT (NON-DEMOUNTABLE TYPE).

(a) *Removal.* Position hub assembly so that bolt heads are accessible. Mark the *exact center* of bolt head with a center punch, then with a 7/8-inch drill positioned on mark, drill a hole to approximate depth shown in figure 175. The hole must be deep enough so that bolt head is severed from bolt. While drilling bolt head, be certain that drill is alined correctly. Position a blunt pointed drift pin in drilled hole, then strike drift pin firmly with a hammer until bolt is driven out of hub. Perform above operation on balance of bolts, then remove drum from hub.

(b) *Front Drum Installation.* Position and aline drum on hub, then insert wheel bolts through drum and hub. Make certain that serrations on bolt and in hub are in alinement. Drive or press wheel bolts firmly in place. Wheel bolts must be a tight press fit.

(c) *Rear Drum Installation.* Position and aline drum on hub, then place gasket between inner side of drum and oil deflector. The small hole in gasket and channel in deflector must be alined with oil relief hole in brake drum. Insert wheel bolts, with bolt and hub serrations in alinement, through oil deflector, gasket, drum, and hub.

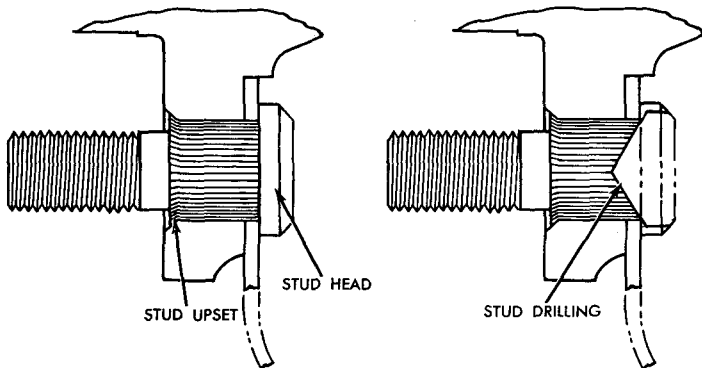

Figure 175—Removal and Installation of Hub Bolts
(Front Shown)

RA PD 332754

SERVICE BRAKE SYSTEM

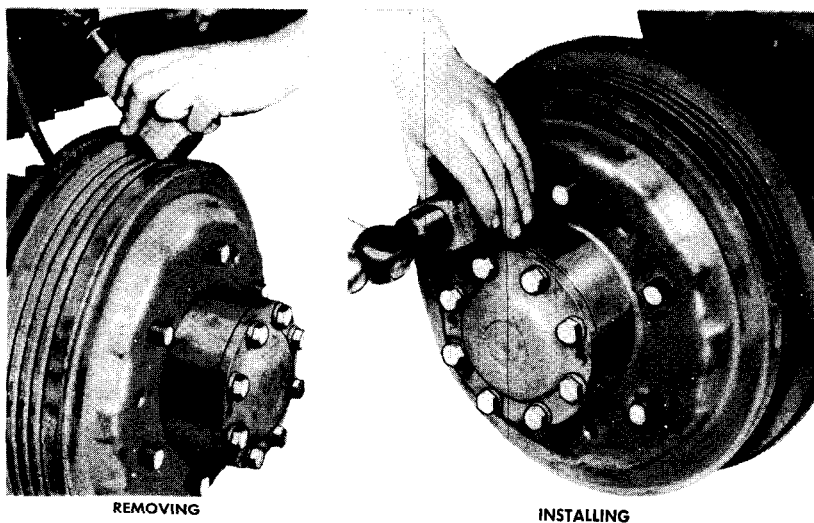

Figure 176—Removing and Installing Demountable Drum (Banjo Type Axle)

RA PD 332901

Drive or press wheel bolts firmly in place. Wheel bolts must be a tight press fit.

(2) **DRUM REPLACEMENT (DEMOUNTABLE TYPE)** (fig. 176). Remove three slotted countersunk head screws which attach brake drum to hub. Apply a few drops of penetrating oil through each hole in drum so that it might flow around shoulder on hub where brake drums fit. Allow penetrating oil sufficient time to act, then position a block of wood in a groove of the drum and drive drum evenly from shoulder. Reinstall by driving drum into place with a block of wood.

b. With Split Type Axles (fig. 177). Brake drums on vehicles equipped with split type axles are demountable type. The front brake drums are attached to the hub with cap screws, while the rear brake drums are attached to hub with countersunk screws.

(1) **FRONT BRAKE DRUM REPLACEMENT.** Remove six cap screws and lock washers which attach drum to hub adapter. Reinstall three of the cap screws in three additional puller screw holes in drum. Tighten screws alternately and evenly until drum is free. Install drum so that attaching screw holes match with those on hub adapter. Tighten cap screws evenly and firmly, using new lock washers.

(2) **REAR BRAKE DRUM REPLACEMENT.** Remove countersunk head screws which attach drum to hub. Apply a few drops of penetrating oil at point where drum contacts pilot shoulder of hub. Place a soft metal bar between wheel studs and strike bar sharply with hammer. This must be accomplished all around the hub until drum is loosened sufficiently to lift off of hub. When installing the drum,

TRUCK, 2½-TON, 6 x 6

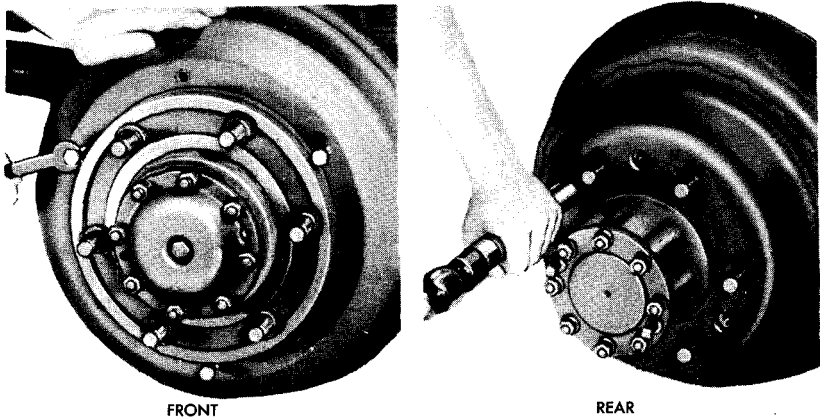

RA PD 332855

**Figure 177—Removing and Installing Demountable Drum
(Split Type Axle)**

position drum over ends of wheel bolts, then drive drum into place with a block of wood and hammer. Install the attaching screws and tighten firmly.

186. BRAKE PEDAL AND LINKAGE.

a. The brake pedal, mounted on a cross shaft with the clutch pedal, is linked to hydraulic master cylinder cross shaft outer lever with an adjustable pull rod. The rod can be adjusted at clevis for pedal to toe board clearance. A return spring at master cylinder end of rod returns pedal to fully released position after pedal pressure is released.

b. Pedal and Pull Rod Removal (fig. 178).

(1) **DISCONNECT CLUTCH PEDAL LINKAGE.** Remove floor and toe board. Disconnect clutch pedal pull back spring. Loosen check nut and adjusting nut on clutch pedal adjusting link. Unhook link from pedal.

(2) **DISCONNECT BRAKE PEDAL LINKAGE.** At pedal, remove clevis pin from rod yoke. At master cylinder outer lever, remove clevis pin from adjustable yoke and withdraw rod. Disconnect pedal return spring [(GM-369935) G501-03-89794].

(3) **REMOVE PEDALS AND BRACKET.** Remove three cap screws which attach pedal bracket to transmission and clutch housing. Bracket with pedals can then be withdrawn as an assembly.

(4) **REMOVE PEDALS.** Remove taper pin which attaches collar to shaft. Collar, clutch pedal, and brake pedal may then be withdrawn from shaft.

c. Pedal and Pull Rod Installation.

(1) **INSTALL PEDALS TO SHAFT AND BRACKET.** Install brake

SERVICE BRAKE SYSTEM

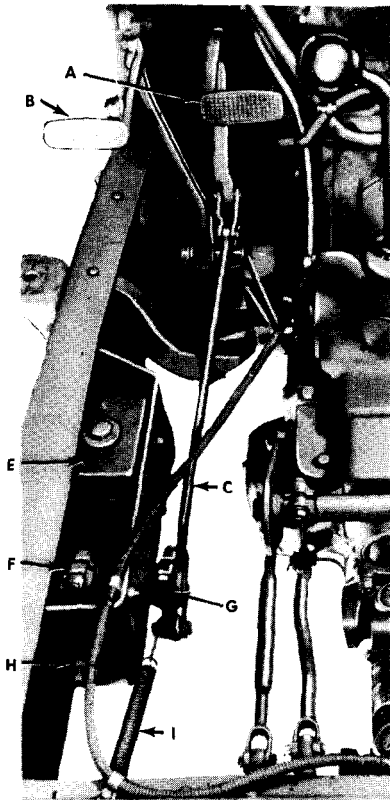

PEDAL AND LINKAGE INSTALLED

- A BRAKE PEDAL
- B CLUTCH PEDAL
- C PEDAL TO INNER LEVER ROD
- D PEDAL BRACKET
- E MASTER CYLINDER OUTER LEVER
- F MASTER CYLINDER INNER LEVER
- G MASTER CYLINDER INNER LEVER
- H STOP SCREW
- I RETURN SPRING

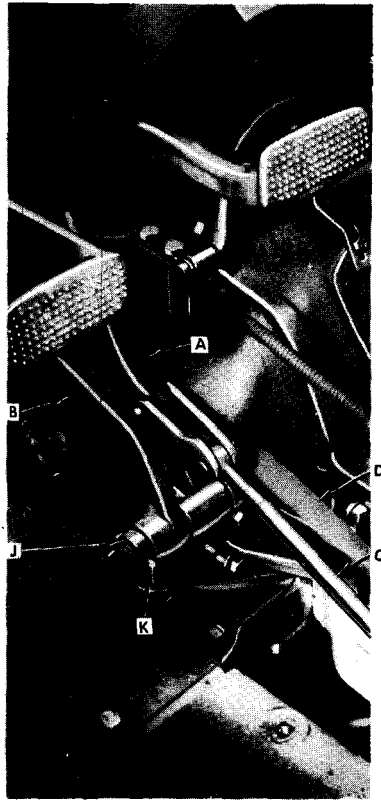

BRAKE AND CLUTCH PEDALS INSTALLED

- G MASTER CYLINDER INNER LEVER
- H STOP SCREW
- I RETURN SPRING
- J COLLAR
- K COLLAR PIN

RA PD 332935

Figure 178—Brake Pedal and Linkage

pedal, then clutch pedal on shaft. Place collar over outer end of shaft and line up pin holes in shaft and collar. Install taper pin.

(2) **INSTALL PEDAL AND BRACKET.** Install bracket with pedals on transmission and clutch housing. Use new lock washers and tighten cap screws firmly.

(3) **CONNECT CLUTCH PEDAL LINKAGE.** Connect clutch pedal link to pedal. Adjust clutch pedal free-travel (par. 150).

(4) **ATTACH ROD TO BRAKE PEDAL.** Install pedal to master cylinder lever rod at pedal. Use new cotter pin. *Do not connect rod to master cylinder outer lever until master cylinder push rod stop screw adjustment is checked and adjusted as described in paragraph 187 d.*

TRUCK, 2½-TON, 6 x 6

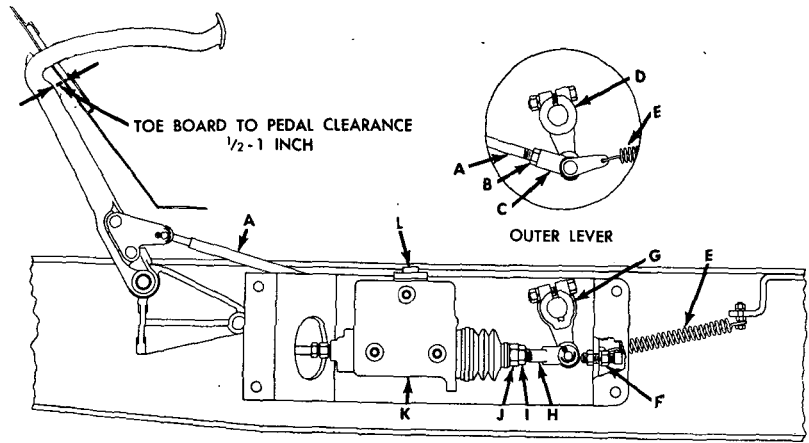

PEDAL AND MASTER CYLINDER LINKAGE

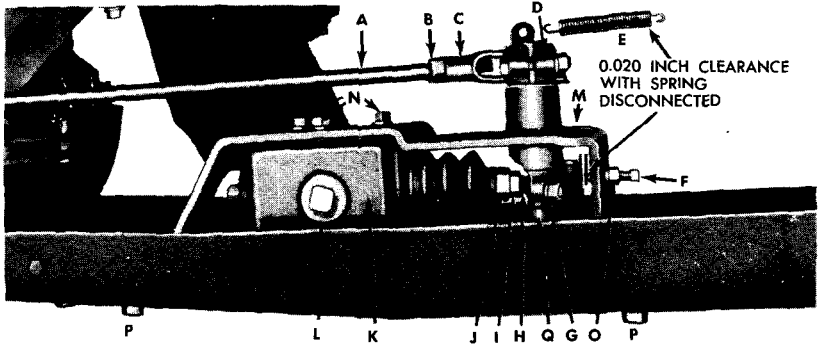

ADJUSTMENT OF STOP SCREW

- | | |
|-------------------------------|----------------------------------|
| A PEDAL TO INNER LEVER ROD | J PUSH ROD NUT |
| B ADJUSTABLE YOKE LOCK NUT | K MASTER CYLINDER |
| C ADJUSTABLE YOKE | L FILLER CAP |
| D MASTER CYLINDER OUTER LEVER | M MASTER CYLINDER BRACKET |
| E RETURN SPRING | N BRACKET TO CYLINDER CAP SCREWS |
| F STOP SCREW | O STOP SCREW LOCK NUT |
| G MASTER CYLINDER INNER LEVER | P FRAME TO BRACKET BALLS |
| H PUSH ROD YOKE | Q LEVER SHAFT |
| I YOKE LOCK NUT | |

RA PD 332934

Figure 179—Pedal and Master Cylinder Linkage

(5) **CONNECT ROD TO OUTER LEVER.** After master cylinder push rod stop screw is checked, connect rod to outer lever and install return spring. Check pedal to toe board clearance as described in subparagraph d below.

d. **Pedal to Toe Board Clearance** (fig. 179). Brake pedal in released position must have ½ to 1 inch clearance between pedal and underside of toe board with pedal in *fully released* position. Withdraw clevis pin at outer lever and remove clevis from lever.

SERVICE BRAKE SYSTEM

Loosen clevis lock nut and turn clevis as necessary to obtain correct clearance at toe board. Tighten clevis lock nut and reinstall to outer lever.

187. HYDRAULIC MASTER CYLINDER AND LINKAGE.

a. The hydraulic master cylinder is comprised of a hydraulic piston and a fluid reservoir. Application of the brake pedal operates push rod through linkage. When the brake pedal is applied, the movement of the pedal through the linkage operates the piston in the master cylinder assembly, displacing hydraulic fluid and building up pressure in the lines which is eventually utilized at the wheel cylinders as pressure is further increased by action of the Hydrovac unit.

b. Master Cylinder and Linkage Removal (fig. 179).

(1) **DISCONNECT BRAKE PEDAL LINKAGE.** Remove floor boards. Disconnect brake pedal return spring. Remove pedal to outer lever rod from outer lever.

(2) **DISCONNECT HYDRAULIC LINE AND SWITCH WIRES.** Disconnect hydraulic line at front of master cylinder [fitting gasket (GM-285059) G67-06-00810]. Remove wires from stop light switch terminals.

(3) **REMOVE MASTER CYLINDER WITH BRACKET.** Remove four master cylinder bracket to frame bolts and nuts. Master cylinder with bracket and levers can then be withdrawn as an assembly.

(4) **REMOVE MASTER CYLINDER FROM BRACKET.** Remove pin from clevis connecting cylinder push rod to inner lever. Remove six master cylinder to bracket cap screws and withdraw master cylinder (GM-21553233). Levers may be removed by loosening clamp bolts. Drive shaft from bracket to remove inner lever.

c. Master Cylinder and Linkage Installation (fig. 179).

(1) **INSTALL MASTER CYLINDER TO BRACKET.** After shaft and inner and outer levers have been installed in bracket, attach master cylinder to bracket. Tighten attaching cap screws firmly. Attach push rod yoke to master cylinder push rod, then attach yoke to lever.

(2) **INSTALL MASTER CYLINDER AND BRACKET.** Install master cylinder and bracket to frame side rail. Tighten attaching bolts and nuts firmly. Install hydraulic line to front of cylinder. Connect stop light switch wires to switch. Fill cylinder with fluid. Check condition of filler cap gasket [(GM-080445) G85-31-05820].

(3) **ADJUST MASTER CYLINDER PUSH ROD.** Loosen yoke to push rod lock nut. With one wrench on push rod nut, and another on lock nut, turn push rod until rear of piston touches stop plate in end of master cylinder. Turn push rod one additional turn (until it is loose in piston) and tighten lock nut. Piston is fully released when rear of piston contacts stop plate at rear of master cylinder barrel. If piston is not allowed to return to a fully released position, piston cup will cover by-pass hole in master cylinder, thereby preventing fluid entering master cylinder barrel on return stroke.

TRUCK, 2½-TON, 6 x 6

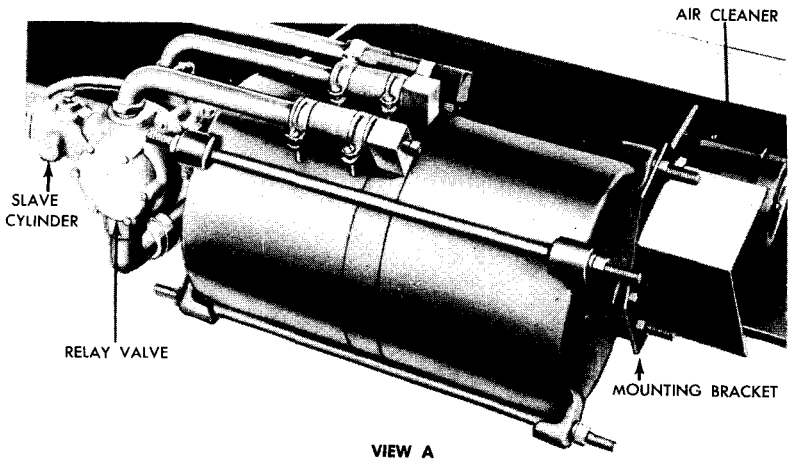

VIEW A

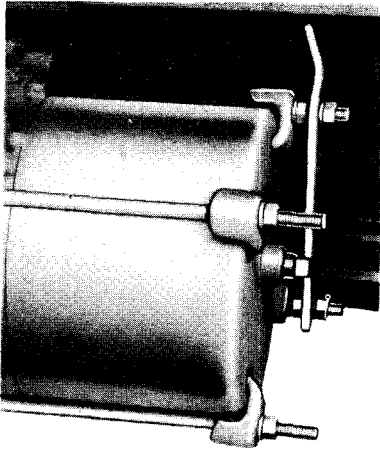

VIEW B

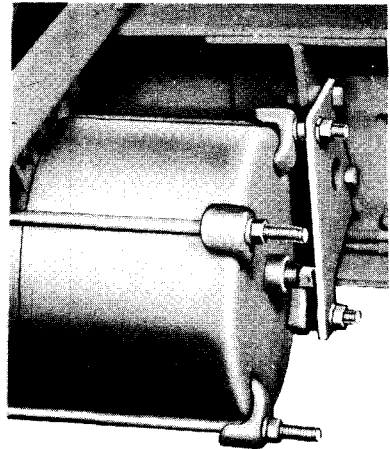

VIEW C

Figure 180—Hydrovac Installed (Oil Wetted Type Cleaner Shown)

RA PD 333015

(4) **IMPORTANT.** Before connecting brake pedal push rod and return spring to outer lever, stop screw at rear of master cylinder must be adjusted as described in subparagraph d below.

(5) **CONNECT LINKAGE TO OUTER LEVER.** After stop screw adjustment has been made, connect pedal pull rod and spring to outer lever. Check and adjust pedal to toe board clearance (par. 186 d).

d. Master Cylinder Push Rod Stop Screw Adjustment. After master cylinder push rod is adjusted as described in subparagraph c (3) above, measure clearance between inner lever and stop screw (fig. 179). If pedal is connected to outer lever, the return spring

SERVICE BRAKE SYSTEM

must be disconnected before this clearance check is made. Adjust the stop screw to permit 0.020 inch clearance between screw and inner lever.

(1) **IMPORTANT.** If this clearance is excessive, the master cylinder piston will strike stop in cylinder too sharply. If clearance is less than 0.020 inch, the piston will not clear fluid by-pass in cylinder when brakes are released. *Do not check or adjust stop screw with return spring connected.* Always check this clearance before making pedal to toe board clearance adjustment.

188. HYDROVAC ASSEMBLY.

a. **Description** (fig. 180). The Hydrovac assembly, located on the inside of the right-hand frame side rail behind the transfer case, consists of a hydraulic slave cylinder, a vacuum suspended power cylinder, and a hydraulic relay valve, all assembled as one complete unit. The Hydrovac unit is so constructed that in case the vacuum power fails, brakes may be applied by hydraulic system with slightly more manual effort. An oil wetted type air cleaner on some vehicles is connected to relay valve and mounted adjacent to Hydrovac unit (fig. 181). On late vehicles, an oil bath air cleaner is mounted on engine side of dash and connected to Hydrovac with tubing (fig. 182).

b. **Cleaning Hydrovac Cleaner.**

(1) **OIL WETTED TYPE** (fig. 181).

(a) *Remove Air Cleaner Shield.* Remove two nuts and lock washers attaching shield to Hydrovac bracket, then remove air cleaner shield.

(b) *Disassemble Air Cleaner.* Remove cover retaining screw

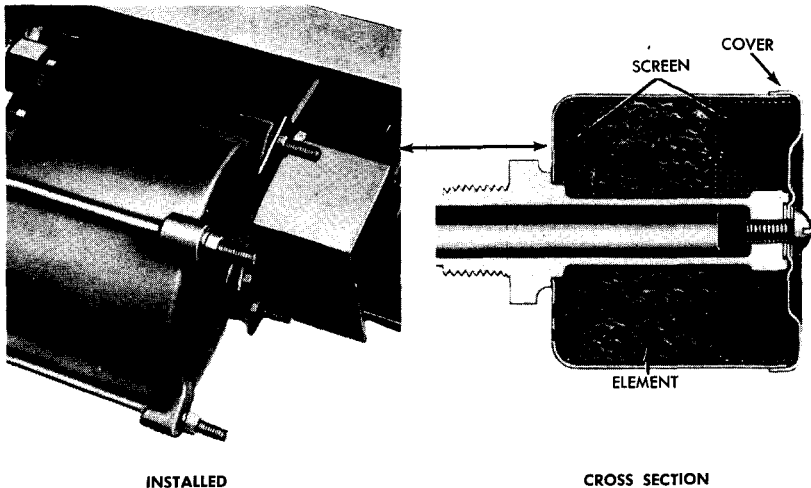

Figure 181—Oil Wetted Type Cleaner

RA PD 332889

TRUCK, 2½-TON, 6 x 6

and washer and remove air cleaner as an assembly from air cleaner stem. Remove cover from air cleaner shell, then extract outer screen, filter hair element, and inner screen from shell.

(c) *Cleaning.* Immerse air cleaner parts in dry-cleaning solvent to loosen and wash out accumulated dirt. Blow all parts dry with compressed air after deposits of dirt have been removed. Immerse curled hair element in light engine oil, withdraw, and allow surplus to drain off.

(d) *Assemble Air Cleaner.* Install air cleaner shell over end of air cleaner stem. Install inner screen (small). Position oil treated element evenly around stem inside of shell. Install outer (large) screen with edge of screen toward cover. Install and secure cover with retaining screws and washer.

(e) *Install Air Cleaner Shield.* Position shield over studs of Hydovac and attach with two nuts and lock washers.

(2) OIL BATH TYPE—DASH MOUNTED (fig. 182).

(a) *Remove Cleaner.* Turn body of cleaner to left until body and element can be withdrawn from bracket.

(b) *Clean Element.* Slush element in dry-cleaning solvent and blow dry with compressed air. Dip element into engine oil (refer to Section VIII, Lubrication).

(c) *Clean and Fill Body.* Slush body in dry-cleaning solvent. Wipe dry. Fill body to oil mark with engine oil (refer to Section VIII, Lubrication).

(d) *Install Cleaner.* Insert element into body. Attach body and element to bracket by turning it to the right on the threads.

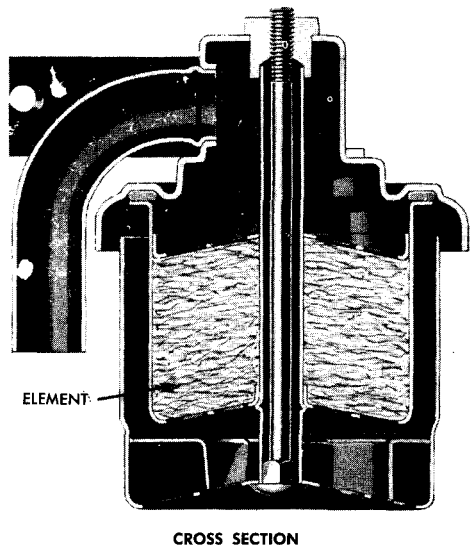
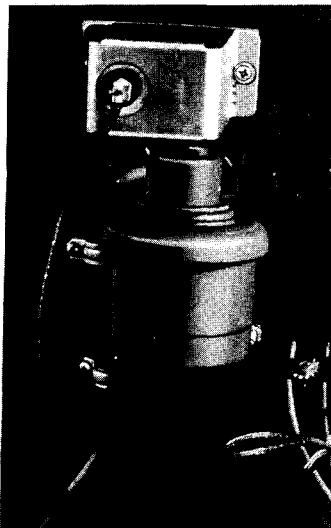

Figure 182—Oil Bath Type Cleaner

RA PD 332886

SERVICE BRAKE SYSTEM

c. **Hydrovac Assembly Removal.** NOTE: *Due to changes in vehicle design, different conditions will be encountered when removing (or installing) the Hydrovac. Difference in mountings are shown in figure 180, and will be noted in text as necessary.*

(1) **DISCONNECT HYDRAULIC LINES.** Disconnect hydraulic outlet line at front end of slave cylinder, and disconnect hydraulic inlet line at bottom rear of slave cylinder.

(2) **DISCONNECT AIR CLEANER TUBE.** Disconnect air cleaner tube at bottom of relay valve. Remove bolt attaching vacuum line clip to frame crossmember.

(3) **REMOVE HYDROVAC.** This procedure depends upon the type of mounting used, and upon the location of the air cleaner. Removal for each mounting shown in figure 180 will be covered separately.

(a) *View A* (fig. 180). Remove two nuts and lock washers attaching Hydrovac to front support bracket. Remove two nuts and lock washers attaching Hydrovac and air cleaner shield to rear support bracket. Remove air cleaner shield, then remove air cleaner from air cleaner stem. Remove nuts and lock washers from two bolts attaching Hydrovac rear mounting bracket to frame side rail, and remove bolts. Move Hydrovac back and lower onto propeller shaft. Loosen clamp attaching vacuum line hose (GM-2156846) to center plate elbow, remove line from elbow, then remove Hydrovac and rear support bracket from under vehicle. Remove rear support bracket and air cleaner tube assembly from Hydrovac cylinder studs.

(b) *View B* (fig. 180). This procedure is the same as step (a) above except that operations pertaining to Hydrovac air cleaner and tube are omitted.

(c) *View C* (fig. 180). Remove two nuts and lock washers attaching Hydrovac to front support bracket. Remove two nuts and lock washers attaching Hydrovac to rear support bracket. Loosen to limit of threads, but do not remove, bolts attaching front support bracket to frame side rail. Loosen to limit of threads, but do not remove, bolts attaching rear support bracket to frame side rail reinforcement. Push Hydrovac forward as far as possible, then pry back on rear support bracket until bracket clears ends of studs. Move Hydrovac back until studs clear front support bracket and lower assembly onto propeller shaft. NOTE: *In the event the brackets will not spread far enough to clear the studs, the extreme ends of the studs may be cut off.* Loosen clamp attaching vacuum line to center plate elbow, remove line from elbow, then remove Hydrovac from under vehicle.

d. **Hydrovac Assembly Installation.**

(1) **INSTALL HYDROVAC.** This procedure depends upon the type of mounting used, and upon the location of the air cleaner. Installation for each mounting shown in figure 180 will be covered separately.

(a) *View A* (fig. 180). Lift Hydrovac up onto propeller shaft and connect vacuum line to center plate elbow. Tighten clamp firmly. Place rear support bracket and air cleaner tube on cylinder studs,

TRUCK, 2 1/2-TON, 6 x 6

and position the assembly at the frame side rail, with the forward ends of the cylinder studs through front support bracket. Install and tighten two bolts, lock washers, and nuts attaching rear support bracket to frame side rail. Install nuts and lock washers on front ends of cylinder studs and tighten firmly. Install air cleaner on air cleaner stem. Position air cleaner shield on cylinder studs, install nuts and lock washers, and tighten firmly.

(b) *View B* (fig. 180). This procedure is the same as step (a) above except that operations pertaining to the air cleaner and tube are omitted.

(c) *View C* (fig. 180). Lift Hydrovac up onto propeller shaft and connect vacuum line to center plate elbow, tightening clamp firmly. Position Hydrovac with front end of studs through front support bracket, then pry back on rear support bracket until rear end of studs will enter holes in rear bracket. Tighten nuts on front and rear support brackets, then install and tighten nuts and lock washers on studs attaching Hydrovac to support brackets at both ends.

(2) **CONNECT AIR CLEANER TUBE.** Connect air cleaner tube to bottom of relay valve and tighten clamp firmly. Install bolt, lock washer, and nut attaching vacuum line clip to frame crossmember.

(3) **CONNECT HYDRAULIC LINES.** Connect hydraulic outlet line to front of slave cylinder and connect inlet line to bottom rear of slave cylinder. Tighten connections firmly.

(4) **LUBRICATE HYDROVAC AND BLEED SYSTEM.** Lubricate Hydrovac as directed in Section VIII, and bleed *entire* brake system (par. 180).

189. WHEEL CYLINDERS.

a. One wheel cylinder is used at each wheel to transmit the hydraulic pressure energy in the hydraulic lines to the brake shoes. The hydraulic pressure forces the wheel cylinder pistons apart and outward. The brake shoes, interconnected with the wheel cylinder assembly, are also forced outward and against the drum, thus applying the brakes.

b. **Removal.** On vehicles equipped with demountable drums, it is only necessary to remove drum (par. 185) to gain access to wheel cylinders. On other vehicles, remove hub, drum, and bearings. If front cylinders are to be replaced, turn off shut-off cock on right-hand frame side rail.

(1) **DISCONNECT BRAKE SHOES FROM WHEEL CYLINDER.** Install wheel cylinder clamp (41-C-1835) over ends of wheel cylinder. Remove brake shoe return spring, then swing brake shoes outward and away from wheel cylinder ends.

(2) **REMOVE WHEEL CYLINDER** (fig. 183). Remove two backing plate to wheel cylinder cap screws and lock washers. Pull cylinder away from backing plate, then disconnect flexible hose [(GM-2196415) front; (GM-2076248) G85-01-01040 rear] connections at wheel cylinder by turning wheel cylinder, while wrench holds hose connection nut. Do not twist hose during this operation.

SERVICE BRAKE SYSTEM

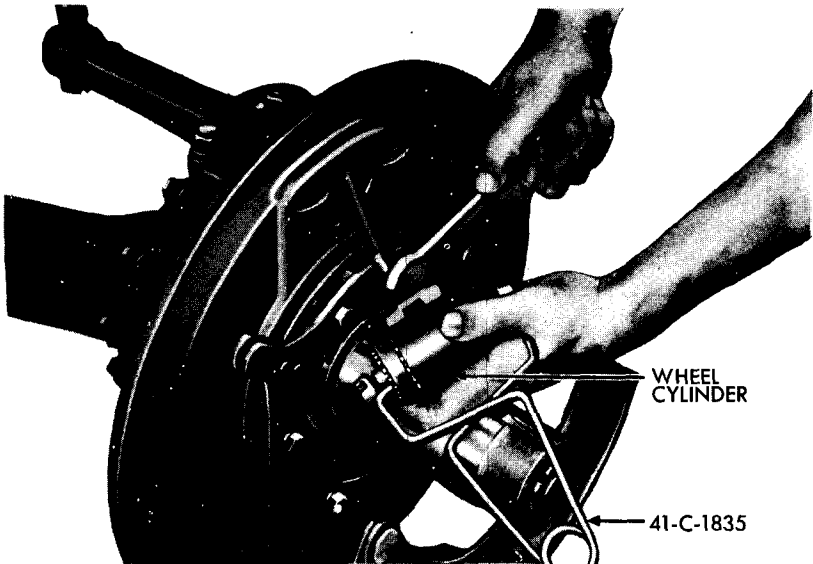

Figure 183—Removal of Wheel Cylinder

RA PD 307367

c. Installation.

(1) **ATTACH WHEEL CYLINDER TO BACKING PLATE.** Place clamp (41-C-1835) over wheel cylinder. Install gasket [split type front only (GM-285059) G67-06-00810] over end of flexible hose with hose inserted through backing plate. Connect hose to wheel cylinder. Hold hose connection nut with wrench to prevent hose twisting, and turn wheel cylinder onto fitting. Install wheel cylinder [split type axle front (GM-2030567) G57-01-45860; banjo type front (GM-5451212) G501-01-45862; rear (GM-5451214) G501-01-45863] to backing plate with two backing plate to wheel cylinder cap screws and lock washers. Tighten cap screws securely. Position brake shoes at wheel cylinder adjusting studs, then install brake shoe return spring and remove clamp.

(2) **INSTALL DRUM, OR HUB, DRUM, AND BEARINGS.** Install demountable drum (par. 185) on vehicles so equipped. On other vehicles, install hub, drum, and bearings, then adjust bearings (par. 199).

(3) **BLEED BRAKES.** After wheel has been installed, open front brake line shut-off cock and bleed brake system (par. 180).

(4) **ADJUST BRAKE SHOES.** Adjust brake shoes at wheel which required cylinder replacement (par. 181).

190. VACUUM CHECK VALVE.

a. (fig. 184). The check valve is installed at the intake manifold in the vacuum line between the intake manifold and the Hydrovac unit. The purpose of the check valve is to seal the vacuum in the

TRUCK, 2½-TON, 6 x 6

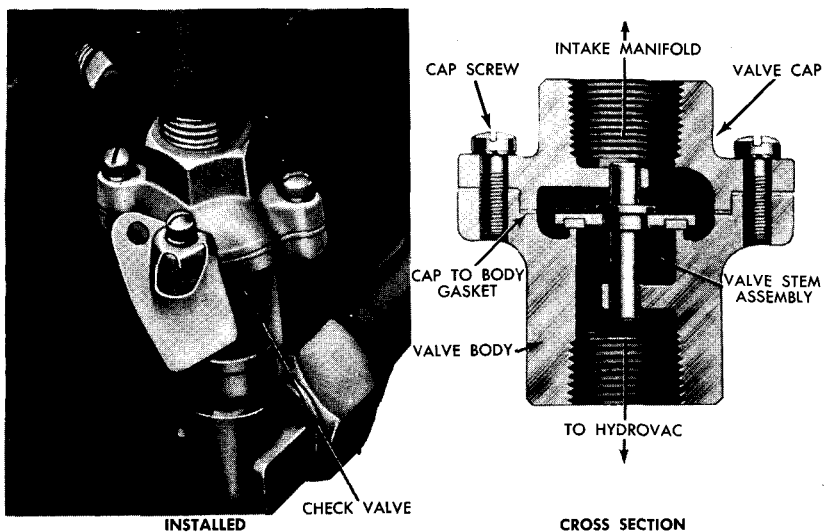

Figure 184—Vacuum Check Valve

RA PD 332865

Hydrovac and vacuum lines. Check valve mechanism seals vacuum in the lines after engine has been stopped, providing sufficient vacuum for a complete brake application.

b. Removal.

- (1) DISCONNECT VACUUM LINE CONNECTION AT VALVE. Disconnect tube nut from elbow at bottom of check valve.
- (2) REMOVE ELBOW. Remove elbow from bottom of check valve.
- (3) REMOVE CHECK VALVE. Remove check valve from intake manifold fitting. Valve is threaded onto manifold fitting.

c. Installation.

- (1) INSTALL CHECK VALVE TO MANIFOLD FITTING. Paint threads of intake manifold fitting, using anti-seize mica base compound. Install check valve to manifold fitting and tighten securely.
- (2) INSTALL ELBOW. Paint male threads of elbow with anti-seize mica base compound, then install in check valve and tighten securely in proper alignment for vacuum line installation.
- (3) INSTALL VACUUM LINE. Install vacuum line connection on elbow, and tighten connection. Make certain that all connections are tightened securely. Check for leaks (par. 179).

191. HYDRAULIC AND VACUUM LINES AND FITTINGS.

a. Hydraulic Lines and Fittings. The hydraulic lines between hydraulic master cylinder and Hydrovac unit and between Hydrovac unit and right- and left-hand frame side rails are metal type and clipped securely to crossmembers and frame side rails. Flexible tub-

SERVICE BRAKE SYSTEM

ing is used between frame side rail connections and each wheel cylinder. These flexible tubings are supported with coil springs and clips attached to the frame side rails at rear and to fender skirts at front.

b. Metal Hydraulic Line Replacement. When the metal hydraulic lines within the frame side rails are replaced, make sure that all connections are tightened securely and that all lines are checked after replacement for leaks. After replacement of all hydraulic lines, bleed the system (par. 180). Metal hydraulic lines are accessible as follows:

(1) **RIGHT-HAND FRONT TO LEFT-HAND FRONT BRAKE LINE.** Right to left front brake line assembly is accessible along the front frame crossmember under radiator. It is clipped to the front crossmember with two clips, bolts, and nuts.

(2) **SHUT-OFF COCK TO FRONT BRAKE LINE.** Shut-off cock to right-hand front brake line tee line is clipped to the right-hand frame side rail and is accessible under the hood and under floor boards in the cab.

(3) **FRONT WHEEL SHUT-OFF COCK (fig. 185).** This shut-off cock is attached to a support on the inside of the right-hand frame side rail and is accessible under the floor boards of cab.

(4) **HYDROVAC TO FRONT SHUT-OFF COCK LINE.** Hydrovac to front shut-off cock line is attached to right-hand frame side rail. This line is accessible under the right-hand side of cab.

(5) **MASTER CYLINDER TO HYDROVAC LINE.** The master cylinder to Hydrovac line assembly extends from master cylinder along left-hand frame side rail, then along crossmember to left-hand frame side rail to tee. This line is clipped to crossmember and frame side rail with four clips, bolts, and nuts.

(6) **RIGHT REAR TO LEFT REAR BRAKE LINE.** Right to left rear brake line extends from right-hand tee along frame crossmember, then to left-hand tee on left-hand frame side rail. This line is clipped to crossmember with two clips, bolts, and nuts.

(7) **INTERMEDIATE RIGHT-HAND BRAKE LINE.** This line extends from right-hand tee to right forward rear axle brake line tee.

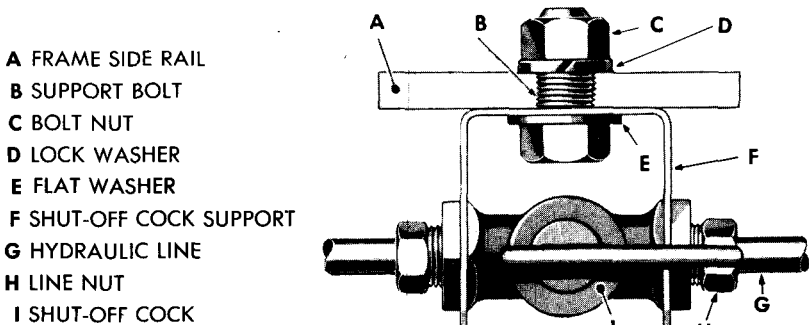

- A FRAME SIDE RAIL
- B SUPPORT BOLT
- C BOLT NUT
- D LOCK WASHER
- E FLAT WASHER
- F SHUT-OFF COCK SUPPORT
- G HYDRAULIC LINE
- H LINE NUT
- I SHUT-OFF COCK

RA PD 64564

Figure 185—Front Wheel Shut-Off Cock

TRUCK, 2½-TON, 6 x 6

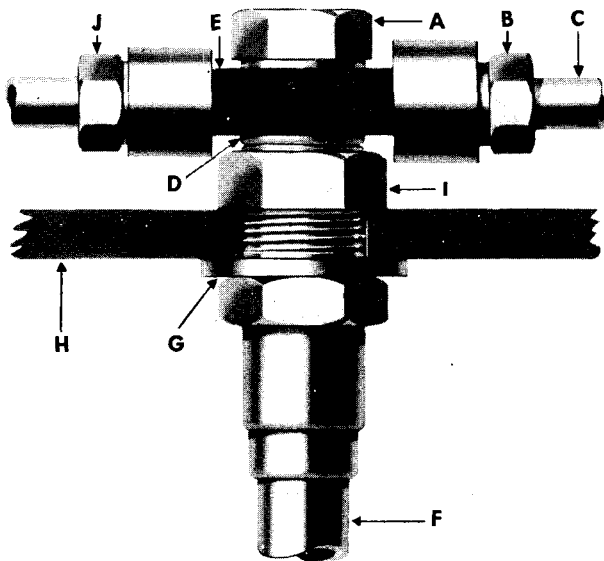

- | | |
|--------------------------|-----------------------|
| A TEE TO FITTING BOLT | F FLEXIBLE HOSE |
| B TUBING NUT | G TOOTHED LOCK WASHER |
| C HYDRAULIC METAL TUBING | H FRAME SIDE RAIL |
| D GASKET | I LOCK NUT |
| E TUBE TEE | J TUBING NUT |

RA PD 333060

Figure 186—Frame Tee Connection

(8) **REAR BRAKE LINES.** The right- and left-hand rear brake lines extend along right and left frame side rails respectively from the forward rear axle brake line connections to the rearward rear axle connections. Each one of these lines is clipped to frame with two clips, bolts, and nuts.

(9) **HYDROVAC TEE TO RIGHT-HAND FORWARD REAR AXLE TEE LINE.** Hydrovac tee to right-hand forward rear axle tee line extends along inside of right-hand frame side rail. This line is held in place by clips, bolts, and nuts.

c. Flexible Tubing and Connection Replacement. Flexible brake lines extending from the frame side rails to the wheel cylinders at each brake assembly on right- and left-hand sides are attached at the frame side rail through special connections.

(1) **TEE CONNECTION** (fig. 186). Tee connections on the frame side rails at the right front wheel, and right- and left-hand forward rear wheels are of special construction. When the flexible lines between these tees and wheel cylinders are removed, it is necessary that tee attaching bolt and lock nut be removed, and hose connection pulled away from frame side rail. After this has been accomplished, the hose can be unscrewed from the wheel cylinder. Make certain

SERVICE BRAKE SYSTEM

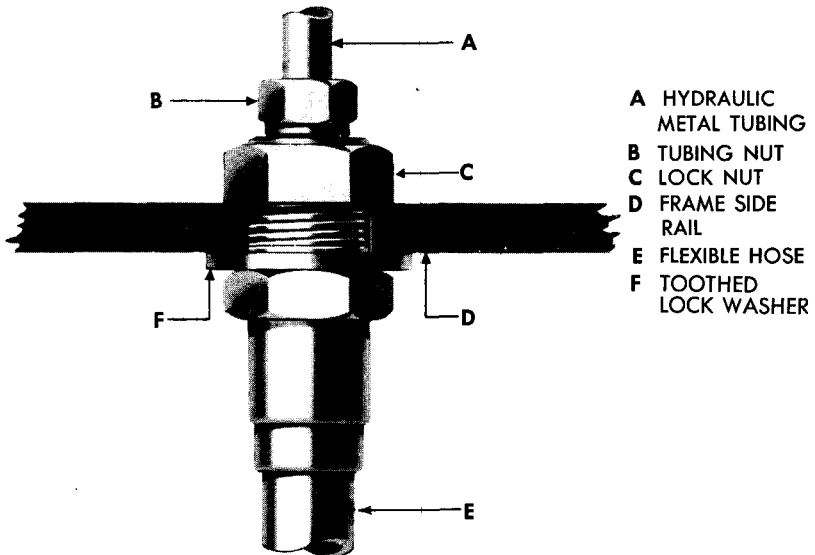

Figure 187—Frame Connection

RA PD 333062

that internal toothed lock washer and new tee gaskets (GM-231343) are positioned properly at installation.

(2) **FRAME SIDE RAIL CONNECTIONS** (fig. 187). The frame side rail connections at left and right rearward rear axle wheels, and left front wheels are special type. When removing the flexible lines with this type connection from wheel cylinder, it is necessary that the lock nut be removed. The flexible hose connection can then be removed from the frame side rail. After it is removed from the frame side rail, the flexible line can be removed from the wheel cylinder. When installing, make certain that a new internal toothed lock washer is used and connection is tightened securely.

d. **Tube Repair.** Hydraulic tubing may be cut and flared with standard flaring equipment.

Section XXXIV

HAND BRAKE SYSTEM

192. DESCRIPTION.

a. **General.** Manually operated hand brake lever at right of driver is connected by a rod and levers to an external contracting type brake band, mounted at rear of transfer case. Brake band assembly

TRUCK, 2½-TON, 6 x 6

is anchored to the transfer case by supports integral with rear bearing cap. Brake drum is bolted between transfer case propeller shaft companion flange and universal joint flange yoke.

b. Operation (fig. 188). As hand brake lever is pulled back, brake rod is pulled forward, applying pressure to cam levers and adjusting bolt at brake band. Movement of cam levers and adjusting bolt draws ends of shoe toward each other, bringing lining into contact with drum. As hand brake lever is moved forward, brake rod moves to rear, transmitting movement to cam levers and adjusting bolt. Ends of band are forced apart by release springs to restore operating clearance between lining and drum.

193. ADJUSTMENT ON VEHICLE.

a. Adjustment Procedure (fig. 189). Adjust when hand brake lever reserve travel is less than one-half of the ratchet range. Operations must be performed in sequence as follows:

(1) **DISCONNECT BRAKE ROD (fig. 189).** Block wheel to prevent vehicle moving. Release brake by pushing hand brake lever forward as far as possible. Remove cotter pin and clevis pin attaching brake rod end to cam levers.

(2) **ADJUST LINING AT ANCHOR (fig. 189).** Remove lock wire at anchor screw slot. Adjust anchor screw to obtain a clearance of 0.010-0.015 inch between lining and drum at anchor. Insert lock wire through anchor bracket and slot in anchor screw, and twist end of wire to lock screw in adjusted position.

(3) **ADJUST LINING AT BOTTOM (fig. 189).** Loosen lock nut on locating screw. Hold screw with screw driver to prevent screw turning while adjusting nut is turned to obtain clearance of 0.020 inch between drum and lining. Tighten lock nut firmly.

(4) **ADJUST LINING AT TOP (fig. 189).** Loosen lock nut at lower end of adjusting bolt. Turn adjusting nut to obtain a clearance of 0.020 inch between lining and drum. Tighten lock nut firmly.

(5) **ADJUST BRAKE ROD (fig. 189).** Loosen brake rod end lock nut. Turn rod end as necessary to aline hole in end with holes in cam levers. Connect rod end to levers with clevis pin and secure with cotter pin. Tighten rod end lock nut firmly, then check hand brake lever for varying degrees of application. Remove blocks from wheels.

194. BRAKE DRUM.

a. Removal.

(1) **DISCONNECT PROPELLER SHAFT.** Block wheel to keep vehicle from moving. Push hand brake lever forward to fully released position. Remove the four nuts and lock washers from propeller shaft flange bolts at brake drum, and push bolts through drum. Telescope propeller shaft slip joint and swing shaft out of the way.

(2) **LOOSEN BRAKE BAND.** Remove lock wire from anchor screw, then remove anchor screw. Remove lock nut and adjusting nut from locating screw, then remove locating screw. Remove lock nut, adjusting nut, washers, and compression spring from adjusting bolt.

HAND BRAKE SYSTEM

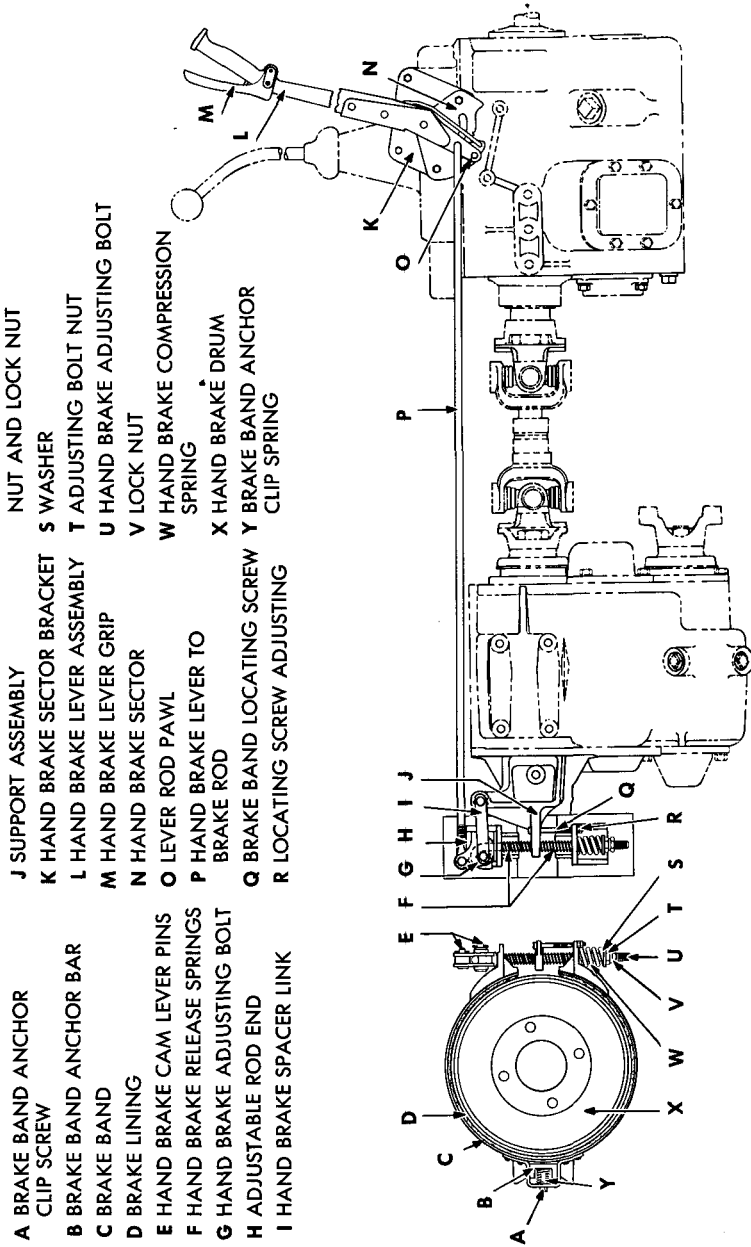

- A BRAKE BAND ANCHOR
- B BRAKE BAND ANCHOR BAR
- C BRAKE BAND
- D BRAKE LINING
- E HAND BRAKE CAM LEVER PINS
- F HAND BRAKE RELEASE SPRINGS
- G HAND BRAKE ADJUSTING BOLT
- H ADJUSTABLE ROD END
- I HAND BRAKE SPACER LINK
- J SUPPORT ASSEMBLY
- K HAND BRAKE SECTOR BRACKET
- L HAND BRAKE LEVER ASSEMBLY
- M HAND BRAKE LEVER GRIP
- N HAND BRAKE SECTOR
- O LEVER ROD PAWL
- P HAND BRAKE LEVER TO BRAKE ROD
- Q BRAKE BAND LOCATING SCREW
- R LOCATING SCREW ADJUSTING
- S NUT AND LOCK NUT
- W WASHER
- T ADJUSTING BOLT NUT
- U HAND BRAKE ADJUSTING BOLT
- V LOCK NUT
- W HAND BRAKE COMPRESSION SPRING
- X HAND BRAKE DRUM
- Y BRAKE BAND ANCHOR
- Z CLIP SPRING

RA PD 332921

Figure 188—Hand Brake, Lever, and Linkage

TRUCK, 2½-TON, 6 x 6

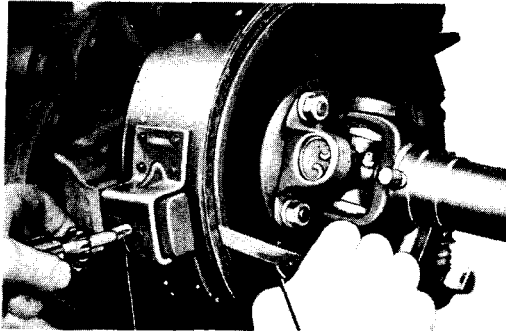

ANCHOR ADJUSTMENT.

ANCHOR SCREW FEELER GAGE

BOTTOM ADJUSTMENT

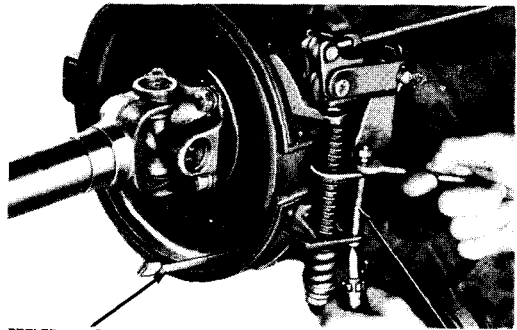

FEELER GAGE

LOCATING SCREW

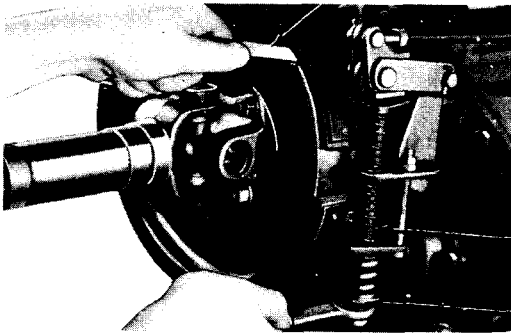

TOP ADJUSTMENT

ADJUSTING BOLT

ADJUSTING NUT

RA PD 332971

Figure 189—Hand Brake Band Adjustment

(3) **REMOVE BRAKE DRUM.** Pull brake band from anchor and swing band and drum to right, pivoting band on adjusting bolt. Use wood block and hammer to drive drum off transfer case companion flange if necessary. Remove drum from band. Whenever brake drum is removed, always examine condition of brake lining; replace band if lining is glazed, burnt, or excessively worn.

b. Installation.

(1) **CLEAN AND INSPECT.** Soak brake drum in dry-cleaning solvent, and wipe dry with clean cloth. Examine drum; replace with new

HAND BRAKE SYSTEM

drum if cracked or broken, or if deeply scored or grooved.

(2) **INSTALL BRAKE DRUM.** Position drum in band, then swing band and drum into position against transfer case companion flange. Swing brake band into position on anchor then install anchor clip spring and anchor screw. Install locating screw, then install adjusting nut and lock nut loosely on locating screw. Install compression spring, washers, adjusting nut, and lock nut on adjusting bolt.

(3) **CONNECT PROPELLER SHAFT.** Position propeller shaft flange to brake drum, position bolts, and install four lock washers and nuts. Make sure drum is properly aligned with mating flanges, then tighten nuts firmly.

(4) **ADJUST BRAKE BAND.** Adjust brake band as described in paragraph 193 a.

195. BRAKE BAND.

a. Removal (fig. 188).

(1) **REMOVE BRAKE DRUM.** Remove brake drum as described in paragraph 194 a.

(2) **DISCONNECT BRAKE LINKAGE.** Remove cotter pin and hand brake cam lever clevis pin attaching linkage to adjusting bolt. Swing brake rod and spacer links out of the way.

(3) **REMOVE BRAKE BAND.** With band disengaged from anchor, rotate band approximately 45 degrees in a counterclockwise direction to permit removal of adjusting bolt. Remove adjusting bolt, release springs, and brake band.

b. Installation (fig. 188).

(1) **INSTALL BRAKE BAND.** Position brake band around brake drum. Insert adjusting bolt through upper bracket on band with hook end up, then install one release spring on bolt. Position assembly of drum and band on vehicle and insert adjusting bolt through hole in support. Swing drum and band to left side of vehicle, at same time rotating band clockwise into position.

(2) **INSTALL SPRINGS AND ADJUSTMENTS.** Swing brake band into position on anchor, then install anchor clip spring and anchor screw. Install bottom release spring on adjusting bolt, position bolt through bottom bracket, then install compression spring, washers, and nuts loosely. Install locating screw, then install nuts loosely on screw.

(3) **CONNECT BRAKE LINKAGE.** Position brake rod cam levers and spacer links to adjusting bolt. Install clevis pin and secure with cotter pin.

(4) **CONNECT PROPELLER SHAFT.** Connect propeller shaft as described in paragraph 194 b (3).

(5) **ADJUST BRAKE BAND.** Adjust brake band as described in paragraph 193 a.

196. BRAKE LINKAGE.

a. Removal (fig. 188).

(1) **DISCONNECT BRAKE ROD.** Block wheels to prevent movement of vehicle. Remove floor pan, then remove cotter pin attaching brake rod to hand brake lever. Remove cotter pin and clevis pin attaching brake rod end to cam levers, then remove brake rod from vehicle.

TRUCK, 2½-TON, 6 x 6

(2) **REMOVE LEVER, SECTOR, AND BRACKET.** Remove two cap screws and washers attaching sector bracket to transmission. Remove hand brake lever, sector, and sector bracket as an assembly from vehicle.

(3) **DISASSEMBLE LEVER, SECTOR, AND BRACKET.** Remove two nuts and lock washers from bolts attaching sector to sector bracket, remove two bolts and spacers, then remove sector bracket. Remove bolt and washer attaching hand brake lever to sector, then separate sector from lever.

b. Installation (fig. 188).

(1) **ASSEMBLE LEVER, SECTOR, AND BRACKET.** Assemble sector and lever with bolt and nut. Install two bolts through lower holes in sector bracket with flat head bolt in countersunk hole. Install a spacer on each bolt, then position bracket to sector with bolts inserted through holes in sector. Install two lock washers and nuts, and tighten nuts firmly.

(2) **INSTALL LEVER, SECTOR, AND BRACKET.** Position assembly of lever, sector, and bracket in vehicle. Install two cap screws and lock washers through upper holes in sector bracket into tapped holes in transmission, and tighten cap screws firmly.

(3) **INSTALL BRAKE ROD.** Loosen brake rod end lock nut, then position brake rod in vehicle. Hook end of rod in brake lever and install cotter pin. Turn rod end as necessary to aline hole in end with holes in cam levers. Install clevis pin and secure with cotter pin. Tighten rod end lock nut firmly. Position and install floor pan, then remove blocks from wheels.

Section XXXV

WHEELS, TIRES, AND HUBS

197. WHEELS.

a. Front.

(1) **ALL VEHICLES EXCEPT CHASSIS SERIAL NO. CCKW 353-236404-2 TO 236520-2 (fig. 190).** Each disc-type front wheel is mounted on six hub studs, and is held in place with inner nuts which thread directly on studs. Outer nuts, which permit installation of dual wheels, thread over inner nuts. These wheels are equipped with lock ring type rim (RH type).

(2) **CHASSIS SERIAL NO. CCKW-353-236404-2 TO 236520-2 ONLY (fig. 191).** On these vehicles, single disc wheel is attached to hub with six nuts. Wheel is equipped with side ring type rim (CV type) with bead lock type tire.

b. Rear.

(1) **ALL VEHICLES EXCEPT CHASSIS SERIAL NO. CCKW-353-236404-2 TO 236520-2 (fig. 192).** Dual rear wheels are mounted on

WHEELS, TIRES, AND HUBS

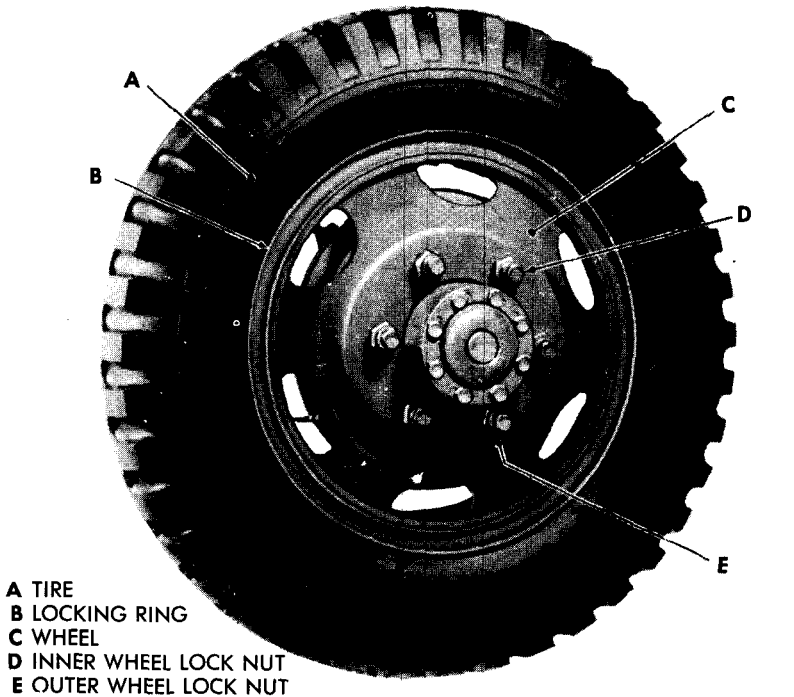

Figure 190—Front Wheel Mounting (Standard)

RA PD 64669

six stud hubs. The inner wheel is held in place with sleeve type square-headed inner nuts, which thread on hub studs. The outer wheel is mounted over inner nuts and is held in place with hex nuts which thread on inner nuts. The wheels are equipped with lock ring type rims (RH type).

(2) CHASSIS SERIAL NO. CCKW-353-236404-2 to 236520-2 ONLY (fig. 191). On these vehicles, each single rear wheel is attached to a wheel spacer by six studs and nuts. Wheel spacer is attached to hub studs by sleeve-type nuts.

c. **Tightening Wheel Nuts.** Wheel nuts on right- and left-hand wheels are not interchangeable. Nuts for right-hand wheels are marked *R*, while nuts for left-hand wheels are marked *L*.

(1) STANDARD WHEELS.

(a) *Front Wheels.* The inner nuts actually hold wheel in place. With wrench furnished with vehicle, tighten inner nuts (square-headed) alternately. Tighten outer (hex) nuts in same manner. *Do not use added extension on wrench.*

(b) *Rear* (fig. 192). Loosen outer nuts (hex), then alternately tighten inner nuts (square-headed) with wrench and extension furnished with vehicle. Tighten outer nuts (hex) in same manner.

(2) WHEELS ON CHASSIS SERIAL NO. CCKW 353-236404-2 to 236520-2 ONLY. Tighten front wheel nuts alternately with wrench

TRUCK, 2½-TON, 6 x 6

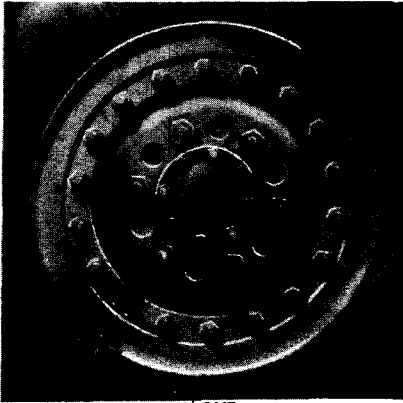

FRONT

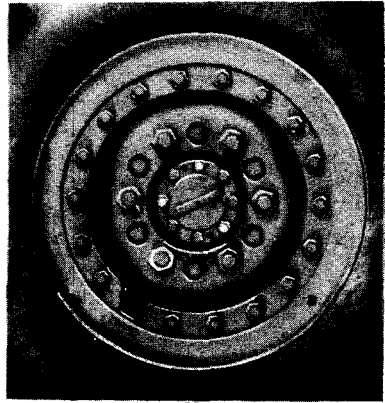

REAR

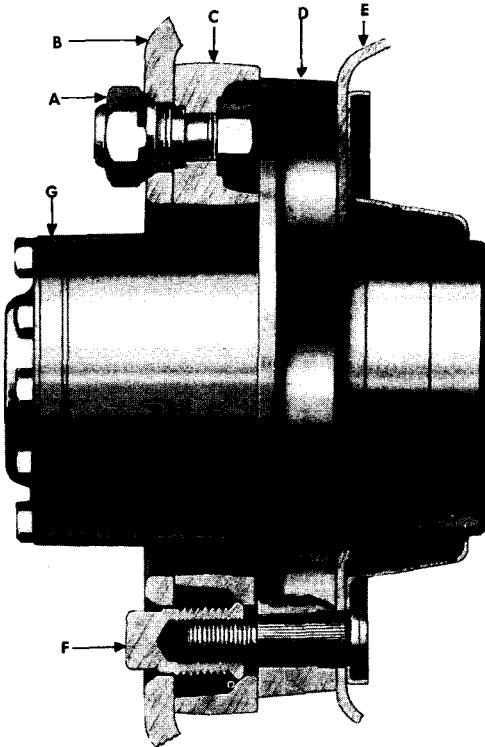

REAR WHEEL MOUNTING

- A WHEEL NUT
- B WHEEL
- C WHEEL SPACER
- D HUB
- E BRAKE DRUM
- F WHEEL SPACER NUT
- G AXLE SHAFT DRIVE FLANGE

Figure 191—Front and Rear Wheel Mounting (Bead Lock Type)

RA PD 333049

WHEELS, TIRES, AND HUBS

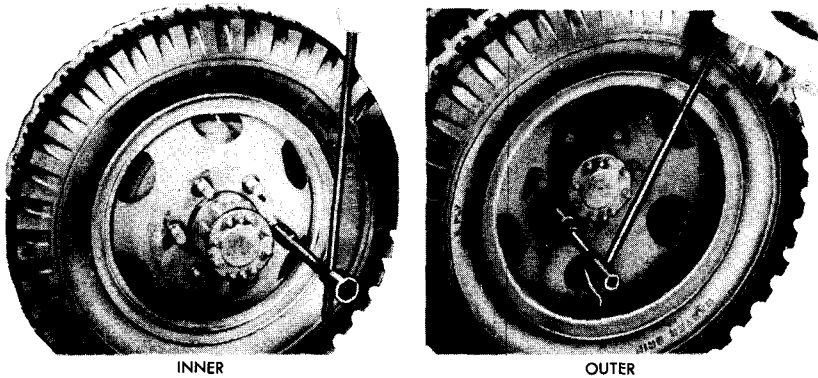

TIGHTENING REAR WHEEL

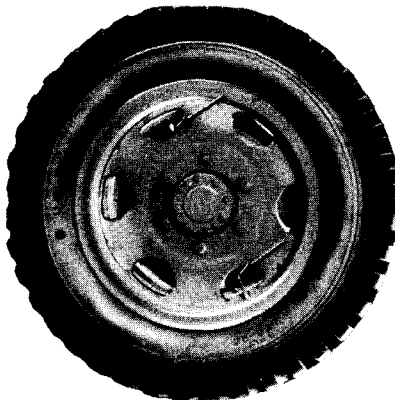

TIRE VALVE POSITION

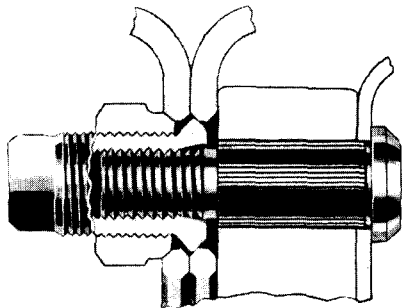

DUAL WHEEL MOUNTING NUTS

RA PD 332974

Figure 192—Rear Wheel Mounting (Standard)

and extension furnished with vehicle. On rear wheels, tighten the square-head spacer nuts first, then the wheel nuts. *Do not attempt to tighten or loosen side ring nuts while tire is inflated. This procedure is dangerous.*

d. Wheel Replacement.

(1) FRONT.

(a) *Standard Wheel.* Jack up wheel until tire clears ground. Remove inner nut [R.H.—(GM-279672) G501-03-14847; L.H.—(GM-279673) G501-03-14848], and outer nut [R.H.—(GM-279670) G501-03-14845; L.H.—(GM-279671) G501-03-14846], together by applying wrench to inner nut (square-head). Install in reverse manner and tighten as previously explained.

(b) *On Chassis Serial No. CCKW-353-236404-2 to 236520-2 Only* (fig. 191). Remove the six wheel nuts. Do not loosen side ring nuts.

TRUCK, 2½-TON, 6 x 6

(2) REAR.

(a) *Standard Wheel* (fig. 192). Remove outer nuts (hex) first; remove outer wheel. Remove all inner nuts (square-head); then remove inner wheel. When installing, install outer wheel in such a position to permit access to inner tire valve stem (fig. 192). Tighten wheel nuts as explained in subparagraph c (1) (a) above.

(b) *On Chassis Serial No. CCKW 353-236404-2 to 236520-2 Only* (fig. 191). Remove the hex wheel nuts only. Do not remove the square-head spacer nuts. After installation, tighten nuts in manner described in subparagraph c (2) above.

198. TIRES AND RIMS.

a. **Standard.** Pneumatic tires are held to rim with a solid clamp ring.

b. **On Chassis Serial No. CCKW 353-236404-2 to 236520-2.** These vehicles are equipped with hinged metal bead lock type rims with a side ring bolted to wheel.

c. **Tire Inflation.** Inflation pressure on standard tire is 55 pounds. On bead-lock tires, the pressure is 40 pounds. Tire pressure in all tires must be equal. Before tires are inflated at regular inspection, each tire should be gaged for pressure loss. When making a pressure loss check, use the same gage on all tires so that any element of gage inaccuracy will be same on all tires. If any appreciable loss is noted in any one tire, that tire should be dismantled and checked.

d. **Tire Replacement.** Replacement tires should be of same make, if possible, as those on vehicle. If tires do not have same outside diameter within ¼ inch, excessive tread scuffing will result. When replacement is made, make selection by measuring outside diameter. Tires may be equipped with either non-directional or directional treads (fig. 193). Non-directional tread tires may be placed in any position on wheels. Directional tread tires must be positioned as follows:

(1) **FRONT.** Mount with the open part of the V-tread in direction of rotation—so that open part of "V" contacts ground first.

(2) **REAR.** Mount so that point of "V" is toward direction of rotation.



ONE TYPE NON-DIRECTIONAL TREAD
PATTERN

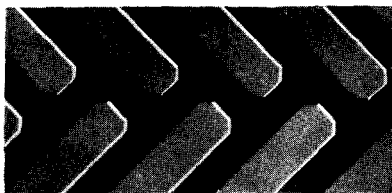

DIRECTIONAL TREAD TYPE PATTERN

Figure 193—Tire Tread Patterns

RA PD 64520

WHEELS, TIRES, AND HUBS

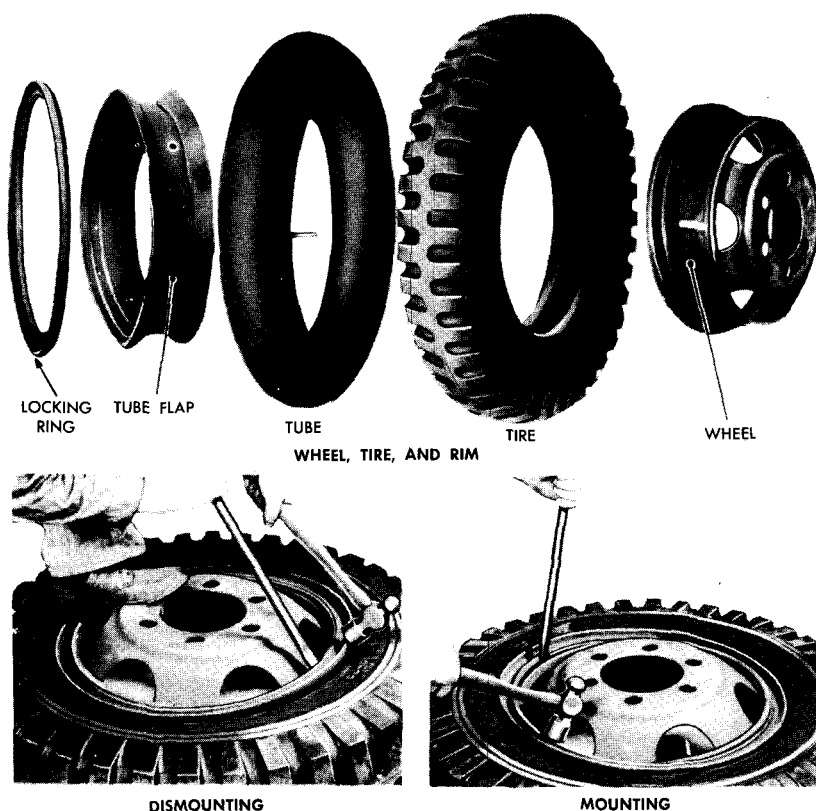

Figure 194—Standard Tire Mounting and Dismounting

RA PD 333016

e. Dismounting and Mounting Tires (Standard Tires) (fig. 194).

(1) **DISMOUNTING.** Jack up vehicle and remove wheel. Lay wheel and tire flat. Deflate tube by removing valve core. Force one side of clamp ring toward center of wheel until it drops into groove in wheel. Insert heavy screw driver into recess in clamp ring and pry this side of ring out over edge of wheel. Work ring off with tire irons and remove tire, flap, and tube.

(2) **MOUNTING.**

(a) *Install Tube.* Install tube in tire so that valve stem is at red dot on sidewall of tire. Install tire flap. Inflate tube sufficiently to prevent tube falling out or being pinched during mounting.

(b) *Install Tire on Rim.* Place wheel flat on floor or ground and drop tire down over wheel. Carefully insert valve stem in hole in rim pointing toward the concave side of the wheel.

(c) *Install Clamp Ring.* Place one edge of clamp ring over edge of rim and force entire ring over rim, using a heavy brass or

TRUCK, 2½-TON, 6 x 6



Figure 195—Bead Lock Tire and Rim Mounting and Dismounting

RA PD 333018

soft metal hammer. Be sure clamp ring is seated against rim of wheel through its whole circumference. Inflate tire to 55 pounds. Install wheel and tighten mounting nuts.

f. **Dismounting and Mounting Tires—Bead Lock Type (CCKW 353-236404-2 to 236520-2 Only) (fig. 195).**

(1) **DISMOUNTING.**

(a) *Remove Wheel and Deflate Tire.* Remove wheel. Completely deflate tire. Do not attempt to remove side ring nuts until tire has been completely deflated.

(b) *Remove Side Ring.* With wrench furnished with vehicle, remove the 17 hex nuts which attach ring to wheel.

(c) *Remove Bead Lock.* Use tire irons around bead of tire to dislodge it from rim. Lift tire, tube, and bead lock from rim. Reinstall valve core and inflate tube enough to spread tire beads. Use lock ring removing bar to pry up on bead lock at a point about eight inches from hinge. Press at point on bead lock marked, "To collapse, press here." After bead lock has collapsed to limit of hinge, turn lock 90 degrees in tire to provide necessary clearance at

WHEELS, TIRES, AND HUBS

valve stem. Remove bead lock from casing, then deflate tube and remove.

(2) MOUNTING.

(a) *Install Tube.* Install tube in casing and inflate enough to hold in place.

(b) *Install Bead Lock over Valve Stem.* With bead lock collapsed, insert valve stem through hole in lock. Install inside of tire with plane of lock at 90 degrees to plane of tire. Collapse and press bead half-way through tire.

(c) *Position Bead Lock in Tire.* Inflate tube sufficiently to spring casing beads apart about same width as bead lock. Turn bead lock in tire from its 90 degree position. While working lock into position between tire beads, turn bead lock until lug near valve stem is directly under stem after bead lock is in position.

(d) *Close Bead Lock Hinge.* Deflate tire completely. Hold one end of lock in place with one foot, and jerk other end up sharply with both hands until hinge snaps into place. Bead lock must be centered so that its edges are below beads of tires all the way around.

(e) *Install Tire on Rim.* Install tire and bead lock assembly on wheel rim with valve stem pointing outward. Be sure that lug on bead lock engages valve stem slot in wheel rim.

(f) *Install Side Ring.* Install side ring and tighten nuts alternately with wrench furnished with vehicle. *These nuts must be tightened before attempting to inflate tire.* Inflate tire, after nuts have been tightened, to 40 pounds. Reinstall wheel, tighten wheel nuts.

199. WHEEL BEARING ADJUSTMENT.

a. **General.** All hubs are mounted on opposed tapered roller bearings which can be adjusted for wear whenever necessary. The actual method of adjustment is the same for both front and rear hubs (split or banjo type axles), however, construction of adjusting nuts, locks, lock nuts, and seals differ on the two types of axles.

b. **Checking Adjustment.** Jack up wheel to be checked until tire clears ground. Check the sideways "shake" of wheels. Grasp tire at top and pull back and forth, or use a long bar under tire. If bearings are correctly adjusted, movement of brake drum in relation to top of dust shield will be just perceptible, with wheel turning freely. If movement is excessive, adjustment is required as explained in subparagraphs c and d below.

c. Front Hub Bearing Adjustment.

(1) BANJO TYPE AXLES (fig. 196).

(a) Remove drive flange (par. 167 b (2)). Bend tangs of lock away from outer nut. With wrench furnished with vehicle (use notched end), remove outer nut. Remove nut lock.

(b) While turning wheel, tighten inner nut until wheel binds. Back off nut about one-eighth turn, then check adjustment.

(c) Install new lock, then bend short tang of lock into a notch of inner nut. Install outer nut and tighten firmly. Check adjustment, then bend long tangs of lock over outer nut. Reinstall drive flange (par. 167 d (6)).

TRUCK, 2 1/2-TON, 6 x 6

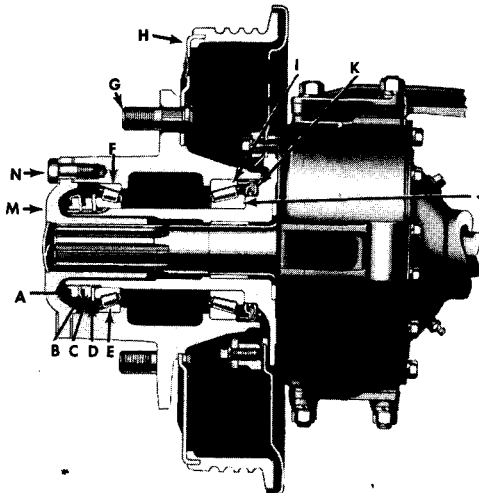

CROSS SECTION—CONVENTIONAL TYPE DRUM SHOWN

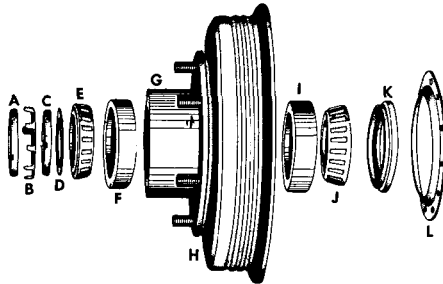

HUB AND DRUM COMPONENTS—CONVENTIONAL TYPE DRUM

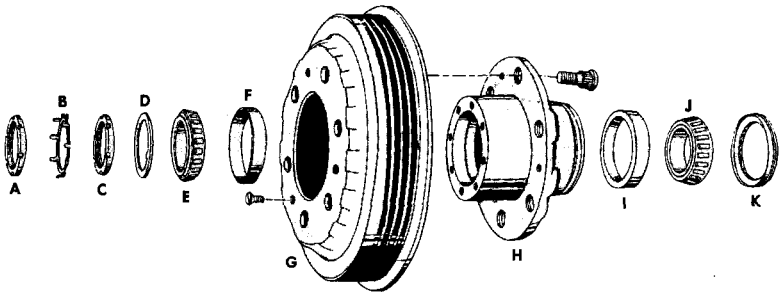

HUB AND DRUM COMPONENTS—DEMOUNTABLE TYPE DRUM

- | | |
|--------------------------|-----------------------------------|
| A OUTER NUT | I INNER BEARING CUP |
| B LOCK | J INNER CONE AND ROLLERS |
| C INNER NUT | K INNER BEARING OIL SEAL ASSEMBLY |
| D WASHER | L INNER OIL DEFLECTOR |
| E OUTER CONE AND ROLLERS | M DRIVE FLANGE |
| F OUTER BEARING CUP | N DRIVE FLANGE CAP SCREW |
| G HUB | O GASKET |
| H DRUM | |

Figure 196—Front Hub and Bearings—Banjo Type Axles

RA PD 333050

WHEELS, TIRES, AND HUBS

(2) **SPLIT TYPE AXLES** (fig. 197).

(a) Remove drive flange (par. 167 e (2)). Bend lock away from outer nut. With hex end of adjusting wrench, remove outer nut. Remove nut lock.

(b) While turning wheel, tighten inner nut until wheel binds. Back off nut about one-eighth turn, then check adjustment.

(c) Install new lock, then bend portion of lock over inner nut. Install and tighten outer nut. Check adjustment, then bend portion of lock over outer nut. Reinstall drive flange (par. 167 g (4)).

d. **Rear Hub Bearing Adjustment** (fig. 198).

(1) **BANJO TYPE AXLES**. Adjustment procedures are same as described for front hub (subpar. c (1) above) except that axle shaft must be removed (par. 171). Outer nut also includes a seal assembly.

(2) **SPLIT TYPE AXLES** (fig. 199). Remove axle shaft (par. 172). Remove outer oil seal and retainer. Balance of procedure is the same as described in subparagraph c (2) above. New axle shaft flange and oil seal retainer gaskets must be used when these parts are reinstalled.

200. CLEANING AND LUBRICATING WHEEL BEARINGS.

a. Whenever hubs and bearings are removed for replacement of parts or at periods indicated in paragraph 37, hubs and bearings must be cleaned and lubricated in following manner:

(1) **PRELIMINARY**. Remove wheels (par. 197). Remove hubs and bearings (par. 201 or 202).

(2) **CLEAN AND INSPECT BEARING CONE AND ROLLER ASSEMBLIES**. Immerse bearing cone and roller assemblies in dry-cleaning solvent. Clean with a stiff brush to remove all old lubricant. Blow dry with compressed air, directing air across bearings. Do not spin dry bearings with air or hands. Inspect rollers for defects and wear. Do not reinstall bearings if pitted, worn, or scored.

(3) **LUBRICATE CONE AND ROLLER BEARING ASSEMBLIES**. Using lubricant specified on Lubrication Order, roll or knead lubricant into rollers, completely filling spaces above and beneath cone. Use bearing lubricator if available. Wrap bearings in clean cloth if not to be installed immediately.

(4) **CLEAN AND INSPECT HUBS AND BEARING CUPS**. Thoroughly wash hub with dry-cleaning solvent, removing all old lubricant. Inspect condition of bearing cups. Replace if worn, distorted, or scored.

(5) **LUBRICATE HUBS AND SPINDLES**. Apply a thin coat (not over 1/16 in. thick) of same lubricant used on bearings to inside surface of hub, outside surface of spindle, and inner surface of drive flange. Do not pack or fill hub with lubricant as this excess may result in leakage onto brake lining.

(6) **DURING AND AFTER INSTALLATION OF HUB AND BEARINGS**. Install hubs and bearings as instructed in paragraph 201 or 202. During installation, coat inner bearing cage and fill space between inner bearing and inner seal with lubricant. After bearing adjust-

TRUCK, 2½-TON, 6 x 6

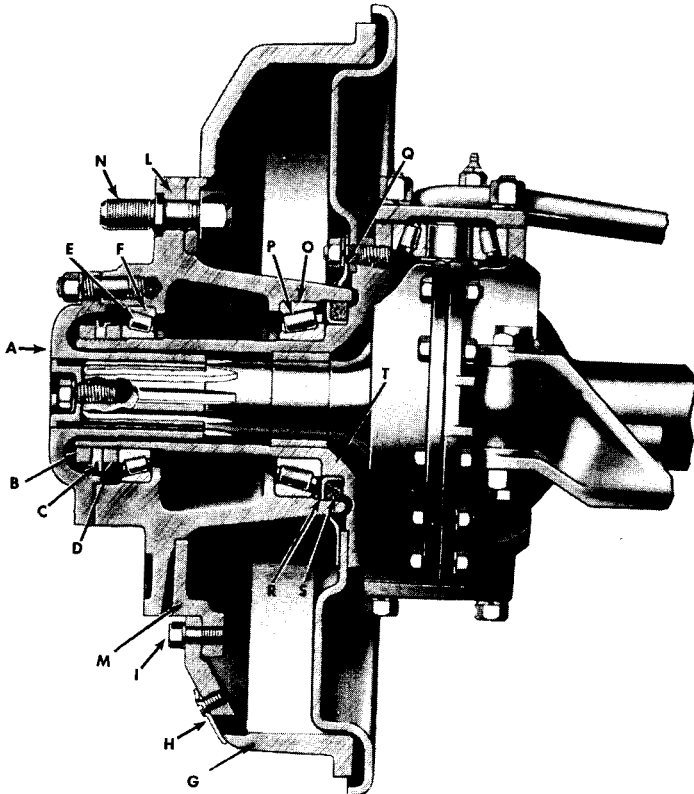

CROSS SECTION—DEMOUNTABLE TYPE DRUM

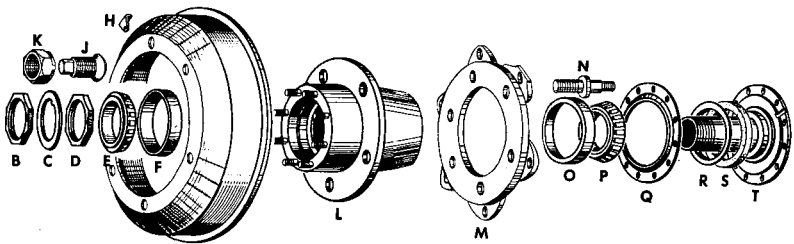

HUB COMPONENTS

- A DRIVE FLANGE
- B OUTER NUT
- C LOCK
- D INNER NUT
- E OUTER CONE AND ROLLERS
- F OUTER BEARING CUP
- G BRAKE DRUM
- H INSPECTION HOLE COVER
- I DRUM CAP SCREW
- J LOCKING NUT, INNER

- K LOCKING NUT, OUTER
- L HUB
- M ADAPTER
- N FRONT WHEEL STUD
- O INNER BEARING CUP
- P INNER CONE AND ROLLERS
- Q SHIELD
- R SEAL RETAINER
- S SEAL
- T KNUCKLE

Figure 197—Front Hub and Bearings—Split Type Axles

RA PD 333029

WHEELS, TIRES, AND HUBS

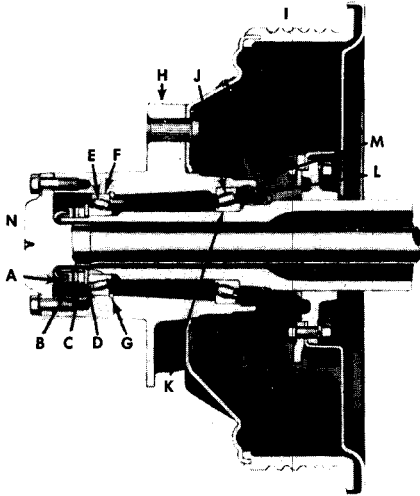

CROSS SECTION—CONVENTIONAL TYPE DRUM SHOWN

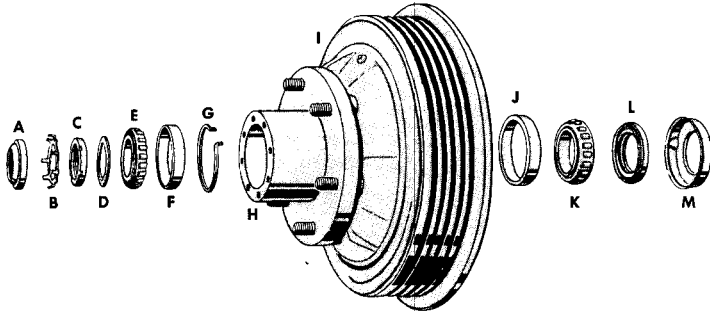

HUB AND DRUM COMPONENTS—CONVENTIONAL TYPE DRUM

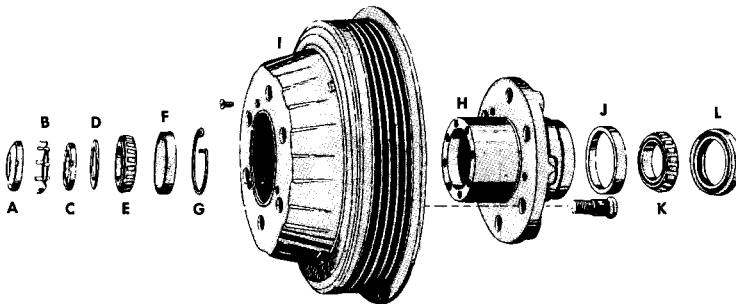

HUB AND DRUM COMPONENTS—DEMOUNTABLE TYPE DRUM

- A OUTER NUT AND SEAL
- B LOCK
- C INNER NUT
- D WASHER
- E OUTER CONE AND ROLLERS
- F OUTER BEARING CUP
- G SNAP RING

- H HUB
- I BRAKE DRUM
- J INNER BEARING CUP
- K INNER CONE AND ROLLERS
- L INNER OIL SEAL ASSEMBLY
- M OIL DEFLECTOR
- N AXLE SHAFT

RA PD 333051

Figure 198—Rear Hub and Bearings—Banjo Type Axles

TRUCK, 2 1/2-TON, 6 x 6

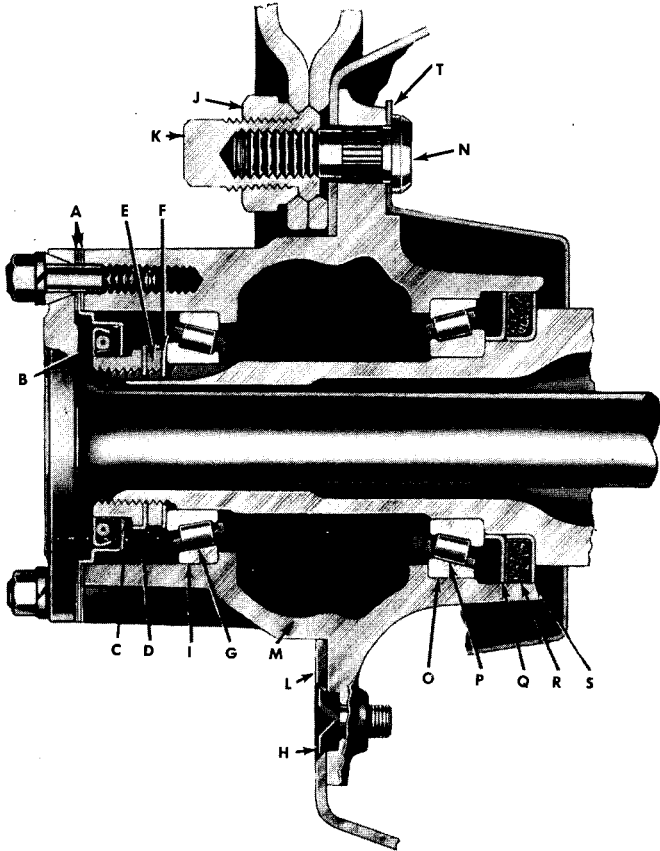

CROSS SECTION

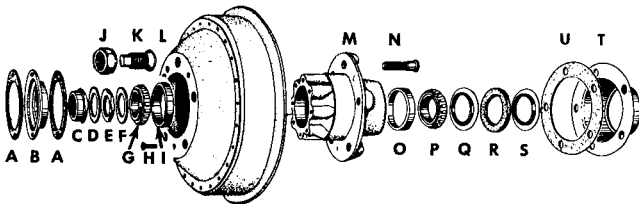

HUB COMPONENTS

- | | |
|--------------------------|--------------------------|
| A FLANGE GASKET | K INNER LOCKING NUT |
| B OUTER OIL SEAL | L BRAKE DRUM |
| C OUTER NUT | M HUB |
| D LOCK | N WHEEL STUD |
| E INNER NUT | O INNER BEARING CUP |
| F WASHER | P INNER CONE AND ROLLERS |
| G OUTER CONE AND ROLLERS | Q RETAINER |
| H DRUM SCREW | R OIL SEAL |
| I OUTER BEARING CUP | S RETAINER |
| J OUTER LOCKING NUT | T SHIELD |
| | U GASKET |

Figure 199—Rear Hub and Bearings—Split Type Axle

RA PD 333002

WHEELS, TIRES, AND HUBS

ment, fill annular space between hub wall and adjusting nut (outside of outer bearing) with lubricant.

201. HUBS AND BEARINGS—BANJO TYPE AXLES.

a. Description.

(1) **FRONT** (fig. 196). The hub and bearings are retained in place with inner and outer adjusting nuts, with a star lock between the two nuts. A spacer washer is used between outer bearing and inner adjusting nut. An oil seal assembly is pressed into inner end of hub.

(2) **REAR** (fig. 198). The hub and bearings are retained in place with an inner adjusting nut and an outer nut and seal assembly. A star lock is installed between inner and outer nuts. A spacer washer is used between outer bearing and inner adjusting nut. An oil seal assembly is pressed into inner end of hub.

b. Front Hub and Bearing Removal.

(1) **REMOVE WHEEL AND DRIVE FLANGE.** Remove wheel. Remove drive flange (par. 167 b (2)).

(2) **REMOVE ADJUSTING NUTS, LOCK, AND SPACER WASHER.** Bend tangs of lock away from outer nut. Remove outer nut and lock [(GM-3659724) G85-31-08140], then remove inner nut and spacer washer.

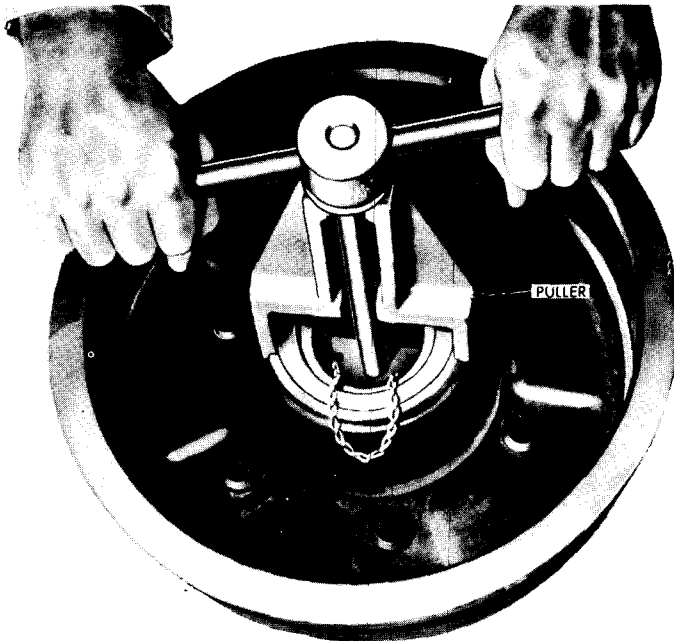

Figure 200—Removing Inner Cone and Rollers (Puller 41-P-2898)

RA PD 332964

TRUCK, 2½-TON, 6 x 6

(3) **REMOVE HUB AND BEARINGS.** Pull hub and drum straight off from steering knuckle. Bearings, cups, and inner oil seal are withdrawn with hub and drum. Remove outer bearing cone and roller assembly [(GM-144507) G85-31-04520] with fingers.

(4) **REMOVE INNER OIL SEAL AND CONE AND ROLLER ASSEMBLY.** With special puller (41-P-2898), remove inner bearing cone assembly, [(GM-186574) G85-31-04500] and inner oil seal [(GM-3665138) G-85-31-12420]. The remover tool is installed in hub by tilting the plate with the chain attached, so that it may be slipped through the bearing and engage the outer race of the bearing. The plate is then held in this position by chain while threading the remover shaft into the tapped hole. The remover body is then located against the seal housing. The bearing assembly and oil seal are removed by turning the remover handle (fig. 200).

(5) **REMOVE CUPS (IF NECESSARY).** Use a drift through inner side of hub. With light hammer, drive on alternate sides to prevent cocking in hub. [Inner cup—(GM-186573) G85-31-05000; outer cup—(GM-142224) G85-31-05020].

c. Front Hub and Bearing Installation.

(1) **CLEAN AND LUBRICATE HUB AND BEARINGS.** Clean and lubricate hub and bearings as directed in paragraph 200.

(2) **INSTALL CUPS.** Install inner and outer cups in hub with

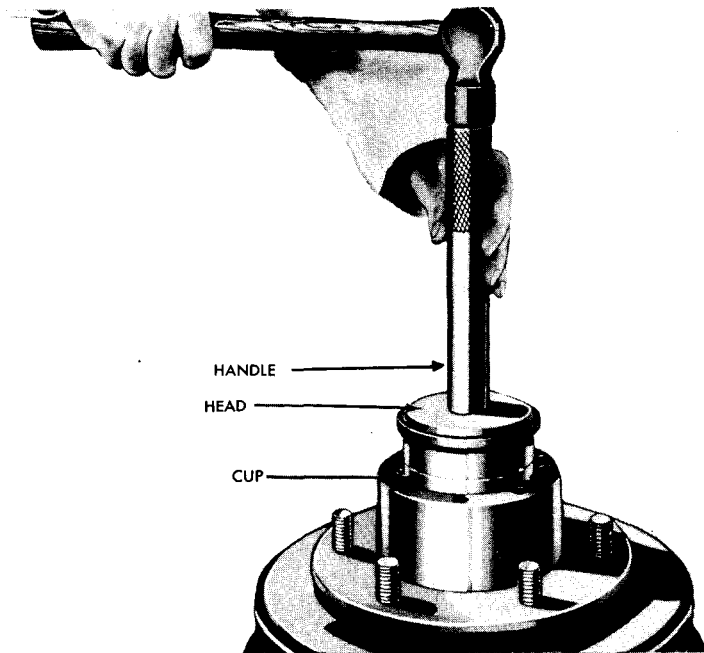

RA PD 332937

**Figure 201—Method of Installing Outer Cup—Front Hub
(Driver Head 41-H-1780 and Handle 41-H-1074)**

WHEELS, TIRES, AND HUBS

wide side of each cup toward center of hub. Use special driver head (41-H-1780) with handle (41-H-1074) in manner illustrated in figure 201 for both cups.

(3) **INSTALL INNER CONE AND ROLLER ASSEMBLY AND OIL SEAL.** Install inner cone and roller assembly in hub; then install new inner oil seal into hub. Use a replacer similar to that illustrated in figure 202, or a block of wood. Flexible portion of seal must be toward bearing. Follow lubrication instructions as described in paragraph 200.

(4) **INSTALL HUB AND OUTER BEARING.** Install hub, then outer bearing. Install spacer washer, inner nut, lock, and outer nut. Tighten temporarily. Do not adjust bearings until wheel is installed.

(5) **INSTALL WHEEL AND ADJUST BEARINGS.** Install wheel, then adjust bearings as described in paragraph 199 c (1). Fill annular space between hub wall and adjusting nut with lubricant (par. 200).

(6) **INSTALL DRIVE FLANGE.** Install drive flange (par. 167 d (6)).

d. Rear Hub Bearing Removal.

(1) **REMOVE WHEEL AND AXLE SHAFT.** Remove wheel. Remove axle shaft (par. 171).

(2) **REMOVE ADJUSTING NUTS, LOCK, AND SPACER WASHER.** Bend tangs away from outer nut, then remove outer nut and seal [(GM-3660091) G85-31-08780], lock [(GM-3660090) G85-31-08180], inner nut, and spacer washer.

(3) **REMOVE HUB AND BEARINGS.** Pull hub and drum straight from axle housing. Bearing cones, cups, and inner seal will be withdrawn with hub. Remove outer bearing cone [(GM-144526) G501-01-39901] from hub with fingers.

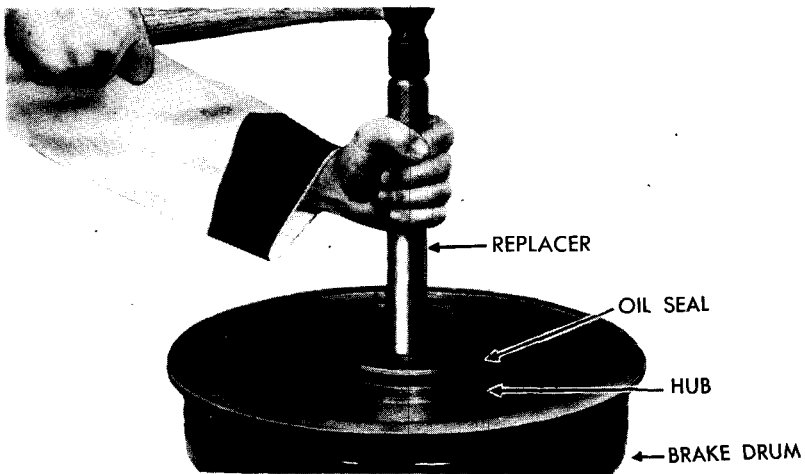

Figure 202—Installing Inner Seal

RA PD 332905

TRUCK, 2½-TON, 6 x 6

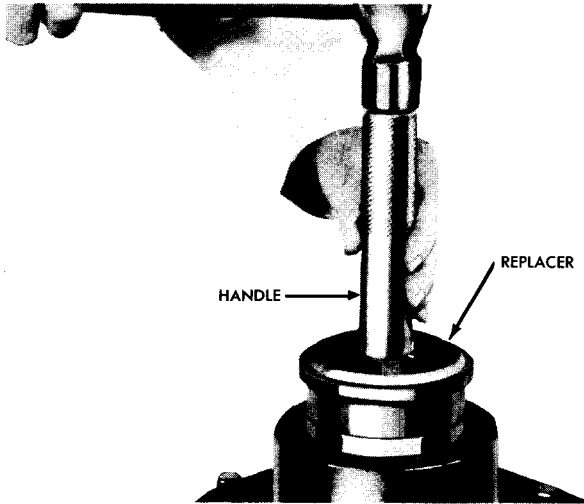

Figure 203—Method of Installing Outer Cup—Rear Hub
(Handle 41-H-1511 with Replacer 41-R-2396-20)

RA PD 332906

(4) REMOVE INNER OIL SEAL AND INNER BEARING CONE ASSEMBLY. Follow instructions described in subparagraph **b** (4) above—[inner cone, (GM-144528) G501-01-39902; seal (GM-599847) G85-31-12560].

(5) REMOVE CUPS (IF NECESSARY). Use a drift through inner side of hub. When removing outer cup, use drift against cup and not against snap ring. Do not remove snap ring unless damaged. [inner cup (GM-127631) G501-01-43548; outer cup (GM-127627) G501-01-43547].

e. Rear Hub and Bearing Installation.

(1) CLEAN AND LUBRICATE HUB AND BEARINGS. Clean and lubricate hub and bearings as directed in paragraph 200.

(2) INSTALL CUPS. Install inner and outer cups in hub with wide side of each cup toward center of hub. On inner cup use special replacer (41-R-2396-22) with handle (41-H-1511). On outer cup use special replacer (41-R-2396-20) with handle (41-H-1511). Drive outer cup against snap ring (fig. 203).

(3) INSTALL INNER CONE AND ROLLER ASSEMBLY. Install inner cone and roller assembly into hub. If new inner oil seal is used, soak in warm engine oil until leather is pliable. Install seal into hub and lock in place by prick punching at three equally spaced points. Follow lubrication instructions in paragraph 200.

(4) INSTALL HUB AND OUTER BEARING. Install hub, then outer bearing. Install spacer washer, inner nut, lock, and outer nut and seal assembly. Tighten temporarily. Install wheel.

WHEELS, TIRES, AND HUBS

(5) **ADJUST BEARINGS.** Adjust bearings as described in paragraph 199 d (1). Fill annular space between hub wall and adjusting nut with lubricant (par. 200).

(6) **INSTALL AXLE SHAFT.** Install axle shaft (par. 171).

202. HUBS AND BEARINGS—SPLIT TYPE AXLES.

a. Description.

(1) **FRONT** (fig. 197). The hub and bearings are retained in place with an inner and outer nut, with a lock between the two nuts. An oil seal and retainer is pressed on steering knuckle at inner end of hub.

(2) **REAR** (fig. 199). The hub and bearings are retained in place with an inner and outer nut with a lock between the two nuts. The outer end of hub is equipped with a spring loaded oil seal assembly installed around outer nut and bolted to hub in conjunction with axle shaft flange. Inner seal is installed on axle housing tube behind inner bearing cone and roller assembly. An oil slinger is bolted directly to hub and drum.

b. Front Hub and Bearing Removal.

(1) **REMOVE DRIVE FLANGE.** Remove wheel. Remove drive flange (par. 167 c (2)).

(2) **REMOVE ADJUSTING NUTS AND LOCK.** Straighten tangs on lock. Remove outer nut, then remove lock and inner nut.

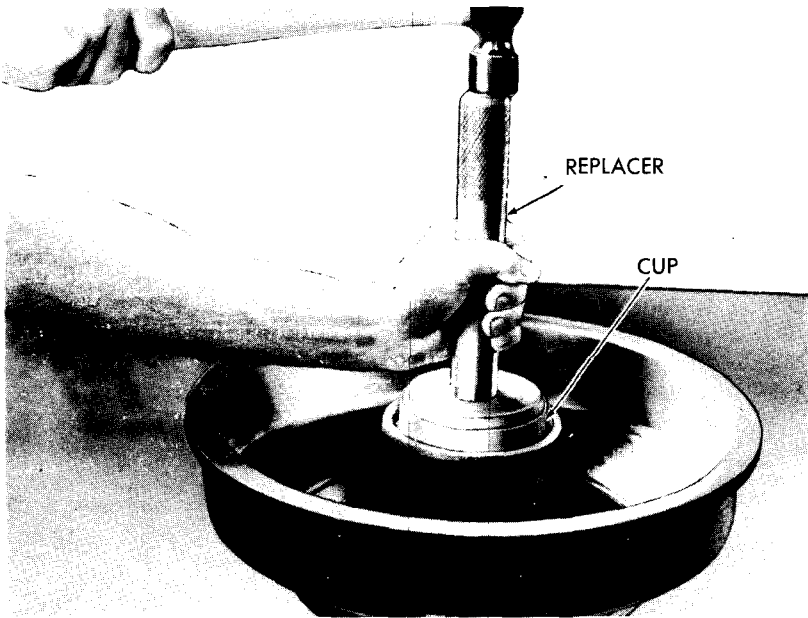

RA PD 332922
**Figure 204—Installing Inner Cup (Driver Head 41-H-1780
with Handle 41-H-1074)**

TRUCK, 2 1/2-TON, 6 x 6

(3) **REMOVE HUB AND BEARINGS.** Pull hub and drum assembly straight off steering knuckle. The outer bearing cone [(GM-144507) G85-31-04520] and both cups will be removed with hub.

(4) **REMOVE INNER BEARING AND SEAL.** Remove inner bearing cone assembly [(GM-186574) G85-31-04500]. Pry inner oil seal [(GM-2031377) G57-03-82801] and retainer from steering knuckle.

(5) **REMOVE BEARING CUPS (IF NECESSARY).** Inspect both inner and outer cups. If worn or pitted, use a drift through inner side of hub to remove. [inner cup—GM-186573) G85-31-05000; outer cup—(GM-142224) G85-31-05020].

c. Front Hub and Bearing Installation.

(1) **CLEAN AND LUBRICATE HUB AND BEARING.** Clean and lubricate as described in paragraph 200.

(2) **INSTALL CUPS** (fig. 204). Install inner and outer bearing cups in hub with wide side of cup toward center of hub. Use special driver head (41-H-1780) and handle (41-H-1074).

(3) **INSTALL INNER SEAL AND RETAINER.** With block of wood, install inner seal and retainer on steering knuckle.

(4) **INSTALL INNER BEARING** (fig. 205). Install inner bearing and cone assembly on spindle using special replacer (41-R-2391-83).

(5) **INSTALL HUB AND DRUM ASSEMBLY.** Position hub and drum over steering knuckle. Insert outer bearing cone and roller assembly

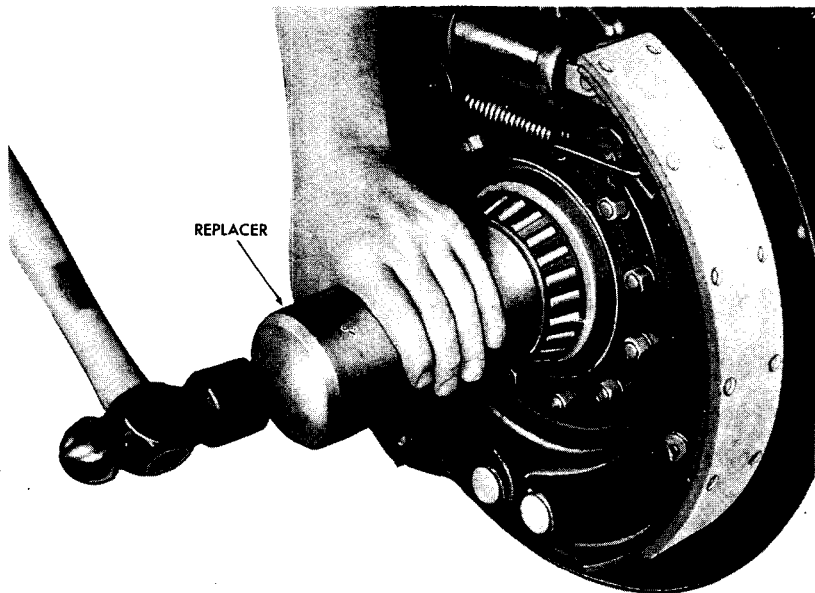

**Figure 205—Installing Inner Bearing Cone and Rollers
(Replacer, 41-R-2391-83)**

RA PD 332915

WHEELS, TIRES, AND HUBS

in place. Follow hub and bearing lubrication instructions in paragraph 200. Install inner nut, lock, and outer nut. Install wheel.

(6) **ADJUST BEARINGS.** Adjust bearings as described in paragraph 199 c (2), then install drive flange (par. 167 g (4)).

d. Rear Hub and Bearing Removal.

(1) **REMOVE AXLE SHAFT.** Remove wheel. Remove axle shaft (par. 172).

(2) **REMOVE HUB AND DRUM.** Remove outer oil seal [(GM-2095544) G57-03-82828], outer nut, lock (GM-057148), and inner nut and washer. Pull hub and drum straight from axle housing. Outer bearing cone [(GM-142257) G85-01-00515] and both cups will be withdrawn with hub.

(3) **REMOVE INNER BEARING CONE AND SEAL.** Remove inner bearing cone assembly [(GM-142258) G85-01-00510]. A slight pry on oil seal [(GM-675758) G85-01-02465] and retainers will remove these parts.

(4) **REMOVE CUPS (IF NECESSARY).** Inspect cups. If worn or pitted, remove by using a drift through inner side of hub. Drive on cups on alternate sides. [Inner cup—(GM-142224) G85-31-05020; outer cup—(GM-142256)].

e. Rear Hub and Bearing Installation.

(1) **CLEAN AND LUBRICATE HUB AND BEARINGS.** Clean and lubricate hub and bearings as directed in paragraph 200.

(2) **INSTALL CUPS (fig. 206).** Install inner and outer cups in hub, using special replacer (41-R-2396-12).

(3) **INSTALL INNER OIL SEAL.** Install inner seal retainer, seal, and outer retainer in place with block of wood.

(4) **INSTALL INNER BEARING CONE (fig. 205).** Install inner

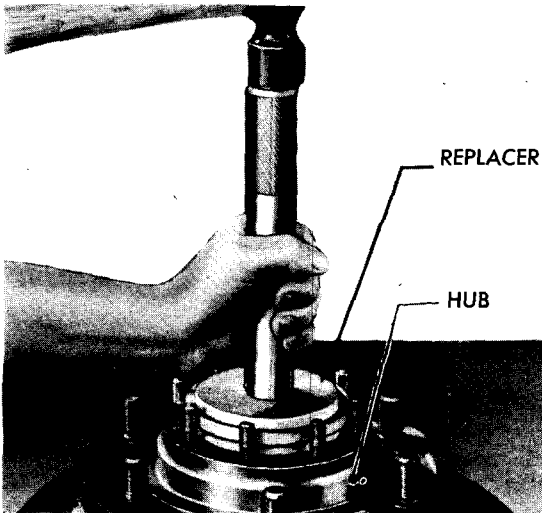

Figure 206—Installing Outer Cup (Replacer 41-R-2396-12)

RA PD 332911

TRUCK, 2½-TON, 6 x 6

bearing cone and roller using special replacer (41-R-2391-83).

(5) **INSTALL HUB AND DRUM.** Position hub and drum over axle housing. Insert outer bearing cone and roller assembly in place. Follow hub and bearing lubrication instructions as described in paragraph 200. Install inner spacer, inner nut, lock, and outer nut. Install wheel.

(6) **ADJUST BEARINGS.** Adjust bearings as described in paragraph 199 d (2).

(7) **INSTALL OUTER OIL SEAL.** Install outer oil seal and retainer, using gasket between hub and seal retainer. Install axle shaft (par. 172).

Section XXXVI

STEERING SYSTEM

203. DESCRIPTION.

a. The steering system consists of a conventional steering gear assembly, mounted on the inner side of the left-hand frame side rail and interconnected to the front axle steering arm by a pitman arm and drag link. Turning the steering wheel transmits movement through the worm, worm nut, pitman shaft gear, and pitman shaft to the pitman arm. The drag link connecting the pitman arm to the axle steering arm, transmits the movement to the front wheels through the steering arm and tie rod.

204. ADJUSTMENT ON VEHICLE.

a. Preliminary Instructions.

(1) The design of the steering gear assembly provides for three adjustments: worm bearings, sector gear lash, and steering gear mounting. These adjustments must be made in the sequence given.

(2) Loosen two nuts on steering column to dash mounting bracket to eliminate any possibility of binding. Make sure steering gear to frame side rail mounting bolts are tight.

(3) Remove lock nuts and nuts from exhaust pipe flange to manifold bolts and remove bolts. Loosen exhaust pipe to muffler clamp bolt and push exhaust pipe down and toward engine.

(4) Disconnect drag link at steering arm (par. 207).

(5) Loosen lash adjuster screw lock nut (fig. 207), and with an offset screw driver, back lash adjuster screw out a few turns.

b. Worm Bearing Adjustment (fig. 207).

(1) **ADJUST WORM BEARING THRUST.** Loosen lock nut on worm bearing adjusting screw and turn adjusting screw counterclockwise a few turns. Turn steering wheel gently to right or left until it stops,

STEERING SYSTEM

then turn wheel back one turn. **CAUTION:** *Approach end of gear travel cautiously to prevent damage to worm nut.* Make sure end cover screws are tight. Tighten worm bearing adjusting screw until end play is removed, then tighten lock nut.

(2) **MEASURE PULL AT STEERING WHEEL RIM.** Use spring scale (41-S-503) to measure pull required to keep wheel in motion. Make test with scale at rim of wheel, with the scale at right angles to the wheel spoke (fig. 208). With wheel in motion, scale should read 1 to 1½ pounds. If necessary, loosen lock nut and turn worm bearing adjusting screw in proper direction to obtain correct reading.

(3) **CHECK FOR "LUMPY" ACTION.** After adjusting worm bearings, check action by turning steering wheel gently from extreme right to extreme left. If any lumpy or uneven action is noted, bearings are damaged. Notify higher authority.

c. Sector Gear Lash Adjustment (fig. 207).

(1) **TIGHTEN SIDE COVER SCREWS.** Make sure there is backlash between gear teeth before tightening side cover screws. Backlash should have been obtained before worm bearings were adjusted (subpar. a (5) above). Determine backlash by grasping pitman arm and noting any free movement of pitman shaft in housing. Remove lock wire from cap screw heads, tighten cap screws firmly, and install new lock wire.

(2) **LOCATE CENTER OF STEERING WHEEL ROTATION.** Turn steering wheel gently from extreme right to extreme left position and count the number of revolutions. Turn wheel back exactly halfway and mark position of wheel with a piece of tape.

(3) **ADJUST SECTOR GEAR LASH.** Tighten lash adjuster screw until all backlash is removed. Tighten adjuster screw lock nut.

(4) **CHECK ADJUSTMENT.** Use spring scale (41-S-503) in same manner as described in subparagraph b (2) above, and note reading as wheel is pulled through center position (fig. 208). This reading



ADJUSTING WORM BEARINGS

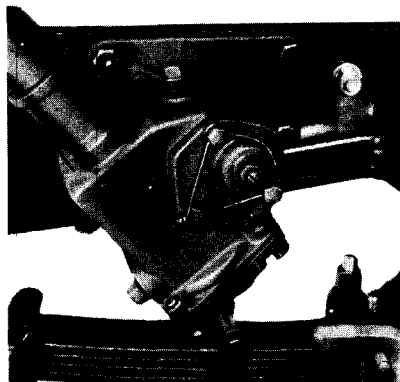

SECTOR GEAR LASH ADJUSTER SCREW

Figure 207—Steering Gear Adjustments

RA PD 332954

TRUCK, 2½-TON, 6 x 6

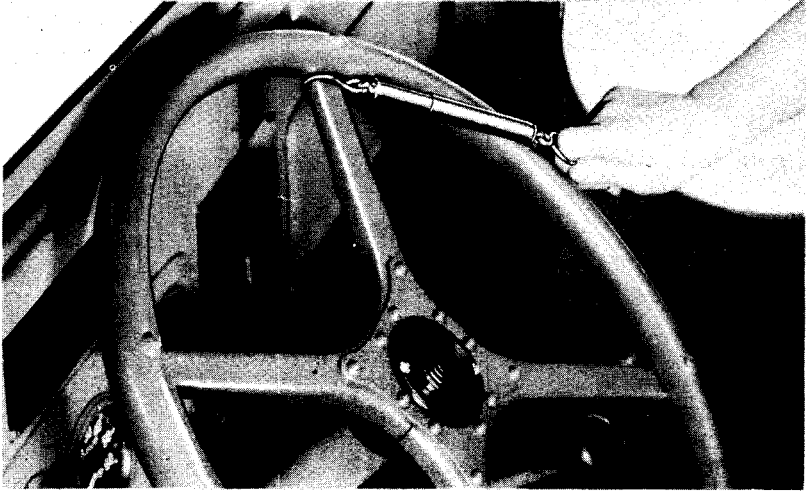

RA PD 332953

**Figure 208—Checking Adjustments with Spring Scale
(Spring Scale 41-S-503)**

should be 2 to 2½ pounds. If necessary, tighten or loosen lash adjuster screw to obtain correct reading.

d. **Steering Gear Mounting Adjustment** (fig. 209). Adjust cab mounting and tighten mounting bolts (par. 221). Loosen four steering gear mounting bolts at frame side rail just enough to permit steering gear to align itself when mounting is tightened at dash. Tighten nuts on steering column to dash mounting. Tighten steering gear mounting bolts at frame side rail with torque wrench, tightening upper front (pivot) bolt last to 160-170 foot-pounds. Install lock nuts on bolts and tighten firmly. Check wheel pull with spring scale (subpar. c (4) above). If pull exceeds 2½ pounds, binding is indicated and cab mounting must be rechecked (par. 221).

e. **Final Operations.**

- (1) Adjust and connect drag link to steering arm (par. 207).
- (2) Connect exhaust pipe to manifold (par. 103), and tighten exhaust pipe to muffler clamp bolt.

205. PITMAN ARM.

a. **Removal** (fig. 210). Remove nut and lock washer attaching pitman arm to pitman shaft. Disconnect drag link from pitman arm ball stud (par. 207). Install puller (41-P-2952) on pitman arm and pull arm off pitman shaft.

b. **Installation** (fig. 210). Set front wheels in straight-ahead position and locate steering wheel at center of travel (par. 204 c (2)). Align serrations in pitman arm with serrations on shaft (fig. 210), and place arm over shaft so that drag link can be installed on pitman arm ball stud without changing the position of the steering

STEERING SYSTEM

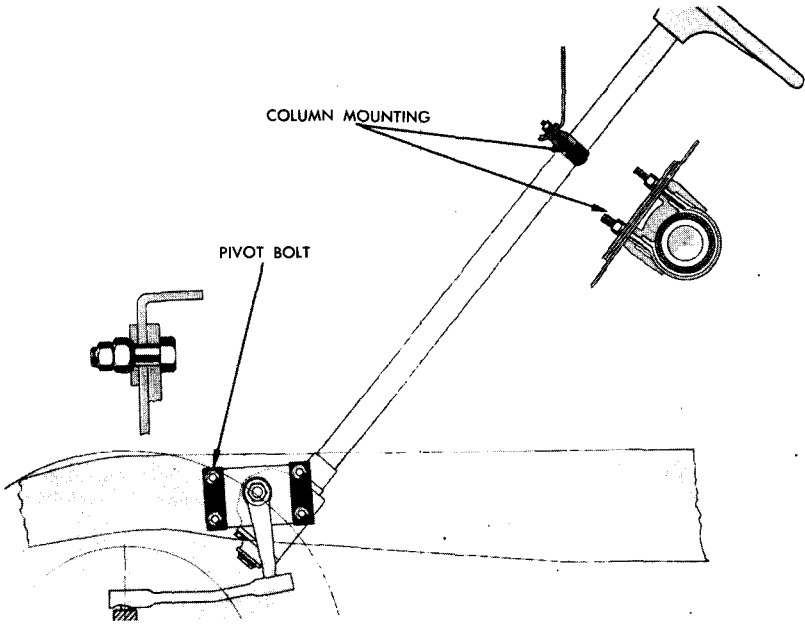

RA PD 332981

Figure 209—Steering Gear Mounting at Frame and Dash

wheel or front wheels. Adjust and install drag link (par. 207). Install lock washer and nut on pitman shaft and tighten nut with torque wrench to 150-160 foot-pounds.

206. STEERING WHEEL.

a. Removal (fig. 211). Remove two screws attaching horn button retainer to steering wheel and remove retainer, horn button, contact, insulator, and spring. Remove steering wheel retaining nut and horn terminal plate. Assemble puller (41-P-2954) and adapter (41-A-18-251) on steering wheel in manner shown in figure 211 and pull steering wheel off worm shaft.

b. Installation. Make sure key is in place in keyseat on worm shaft. Aline keyway in steering wheel hub with key in shaft and place steering wheel on shaft. Install horn terminal plate and steering wheel retaining nut and tighten nut firmly. Install spring, insulator, contact, button, and retainer in steering wheel and attach with two screws.

207. DRAG LINK.

a. Description. The drag link assembly is made up of a tubular shaft fitted with ball socket assemblies at both ends (fig. 212). The end assemblies contain identical parts, but parts are assembled in different sequence in the two ends.

TRUCK, 2½-TON, 6 x 6

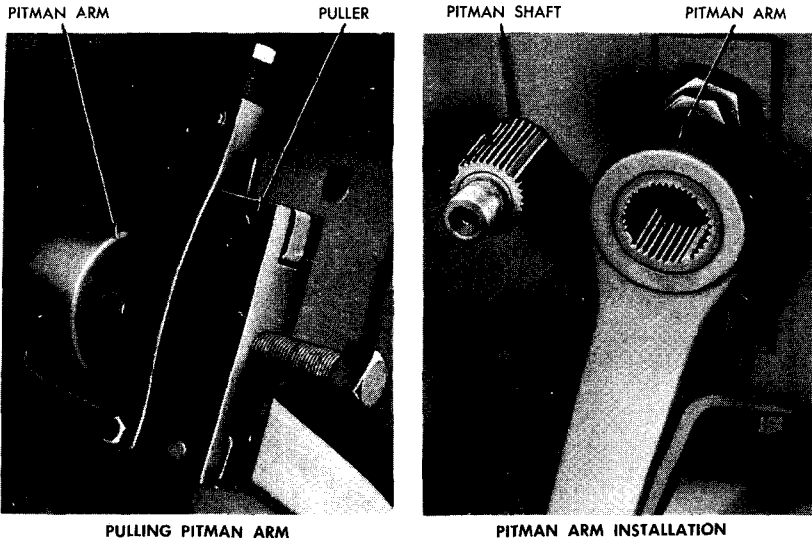

**Figure 210—Pitman Arm Removal and Installation
(Puller 41-P-2952)**

RA PD 332917

b. **Adjustment.** Be sure drag link ball seats are thoroughly lubricated before making adjustment. Remove cotter pin from drag link end. Screw end plug in tight with ball in place, then back off one-quarter to one-half turn and insert new cotter pin. Repeat at other end.

c. **Removal.** Remove cotter pin from both ends of drag link. Back out end plugs as far as possible without removing them. Turn steering wheel in both directions to loosen ball studs in drag link ends, then pull drag link off steering arm ball stud and pitman arm ball stud. **NOTE: Drag link can be disconnected at one end only if so desired for replacing pitman arm or steering arm.**

d. **Installation.**

(1) **CONNECT DRAG LINK TO STEERING ARM.** Opening for ball stud at steering arm end is closer to end than at pitman arm end. Remove end plug from steering arm end and check order in which parts are installed (fig. 212). Correct order is: washer, spacer, safety plug, spring, inner ball seat, outer ball seat, and end plug. Pack lubricant (Section VIII) into ball seats. With inner ball seat in position (notch toward opening), place opening in drag link end over steering arm ball stud. Install outer ball seat and end plug. Do not install cotter pin until adjustment is made.

(2) **CHECK ALINEMENT OF RELATED PARTS.** Before connecting drag link to pitman arm ball stud, turn steering wheel **GENTLY** to extreme left and turn front wheels to left against stop screw. Hold drag link against pitman arm ball; ball should be at least one-half

STEERING SYSTEM

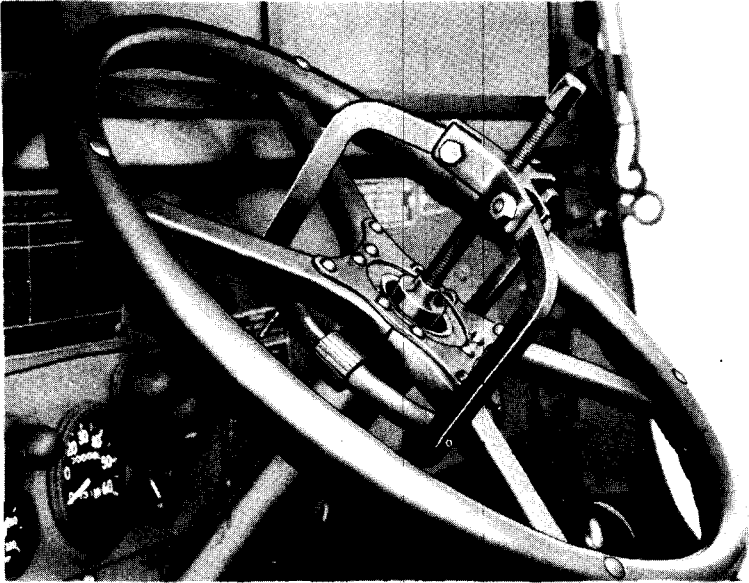

RA PD 316812
Figure 211—Pulling Steering Wheel (Puller 41-P-2954 with Adapter 41-A-18-251)

inch ahead of its position in drag link. Repeat check for extreme right turn; pitman arm ball should be at least one-half inch behind its position in drag link. If over travel of pitman arm ball is less than one-half inch either way or does not reach extreme travel of drag link socket, steering worm nut will strike steering gear housing or end cover, causing damage to worm nut and ball guides. This condition will also cause bending of end cover and loosening cover

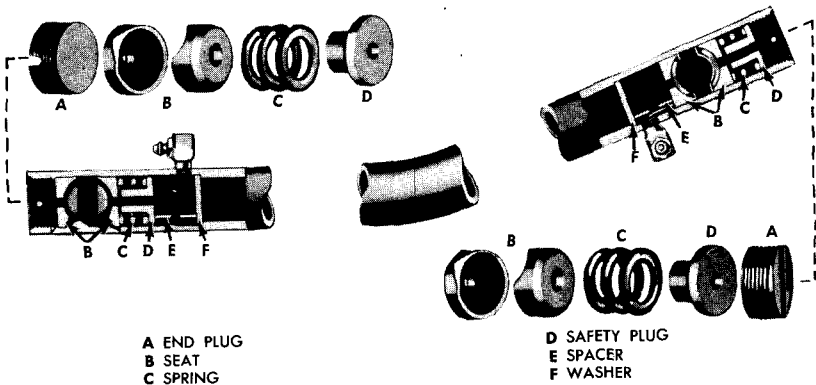

Figure 212—Drag Link Assembly

RA PD 332997

TRUCK, 2½-TON, 6 x 6

screws with resultant oil leaks. If such a condition is present, check the following items, replace damaged parts, or report condition to higher authority.

- (a) Bent or twisted pitman arm.
- (b) Bent drag link.
- (c) Bent or twisted front axle steering arm.
- (d) Front axle out of position on front springs.
- (e) Steering knuckle stop screws out of adjustment, bent, or missing.

(3) **CONNECT DRAG LINK TO PITMAN ARM.** Set front wheels in straight-ahead position and locate steering wheel at center of travel (par. 204 c (2)). Remove end plug from rear end of drag link and check order in which parts are installed. Correct order is: washer, spacer, inner ball seat, outer ball seat, spring, safety plug, and end plug. With washer, spacer, and inner ball seat in place (notch in seat toward opening), pack lubricant (Section VIII) into ball opening. Place opening in side of drag link over pitman arm ball stud and install outer ball seat, spring, safety plug, and end plug in the order named. Adjust both ends of drag link (subpar. b above) and lubricate (Section VIII).

Section XXXVII

FRONT AND REAR SPRING SUSPENSION

208. DESCRIPTION.

a. The front springs are semi-elliptic type, shackled at front and pivoted at rear. The springs are mounted on axle housings with U-bolts on banjo type axles and with studs and bolts on split type axles. Rear spring suspension consists of inverted semi-elliptic springs, mounted on roller bearing spring seats, and retained with U-bolts. Slipper type spring ends are located in guide brackets on each rear axle. The ends of the springs are free to slide forward or backward to permit the springs to lengthen and retract under load compression and rebound action. Torque rods, three at each axle, interconnect the forward rear (intermediate) axle and the rearward rear axle with the trunnion brackets and vehicle frame.

209. FRONT SPRING SUSPENSION.

a. **Description.** Two types of shackles are used on these vehicles, depending upon the type of axle used.

(1) **Y-TYPE SHACKLES—BANJO TYPE AXLES** (figs. 213 and 214). This type shackle is attached to the bracket and spring by means of pins. The outside ends of the pins are grooved to permit installation of clamping bolts. Use of spacer is shown in figure 214.

FRONT AND REAR SPRING SUSPENSION

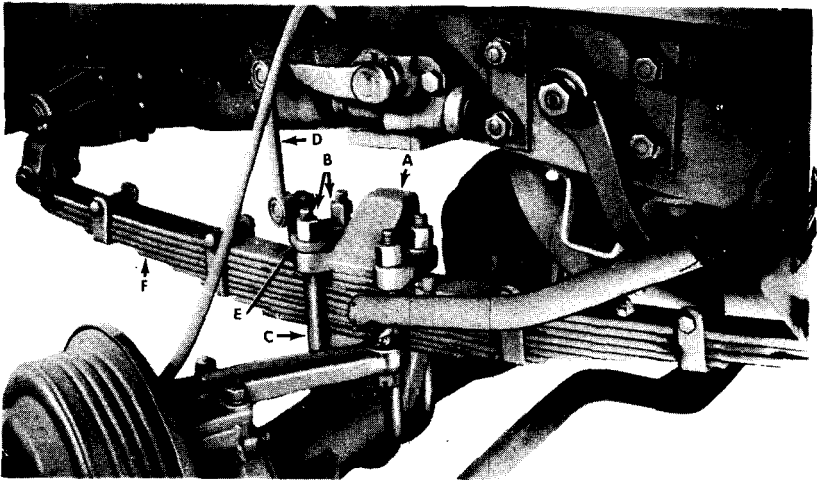

LEFT SIDE

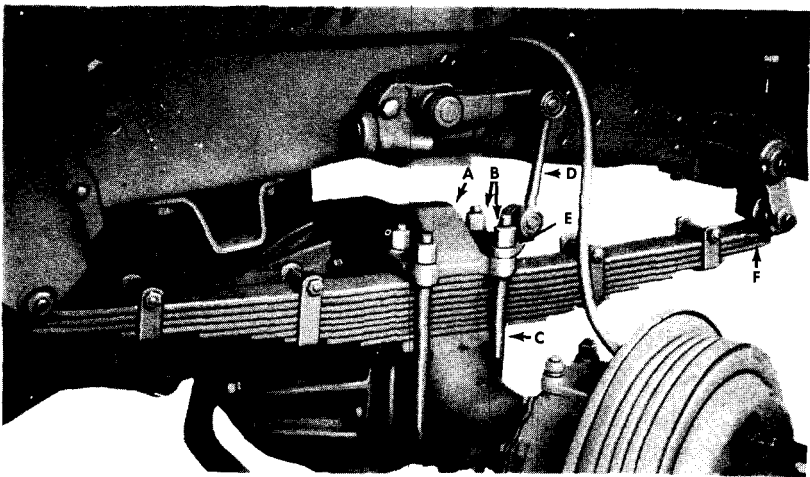

RIGHT SIDE

A BUMPER BLOCK
B U-BOLT NUT
C U-BOLT

D SHOCK ABSORBER LINK
E SHOCK ABSORBER LINK BRACKET
F FRONT SPRING

RA PD 333027

Figure 213—Front Springs Installed—Banjo Type Axle

(2) U-TYPE SHACKLES—SPLIT TYPE AXLES (figs. 215 and 216). This type shackle is attached to the frame bracket and spring by means of shackle bolts. All upper shackle bolts are retained by nuts and cotter pins, while the lower shackle bolts may be retained by nuts and cotter pins, or the bolts may be threaded into the shackles and retained by a lock plate. These differences are shown in figure 215 and are noted, as necessary, in the text when removal or installation procedures are affected.

TRUCK, 2½-TON, 6 x 6

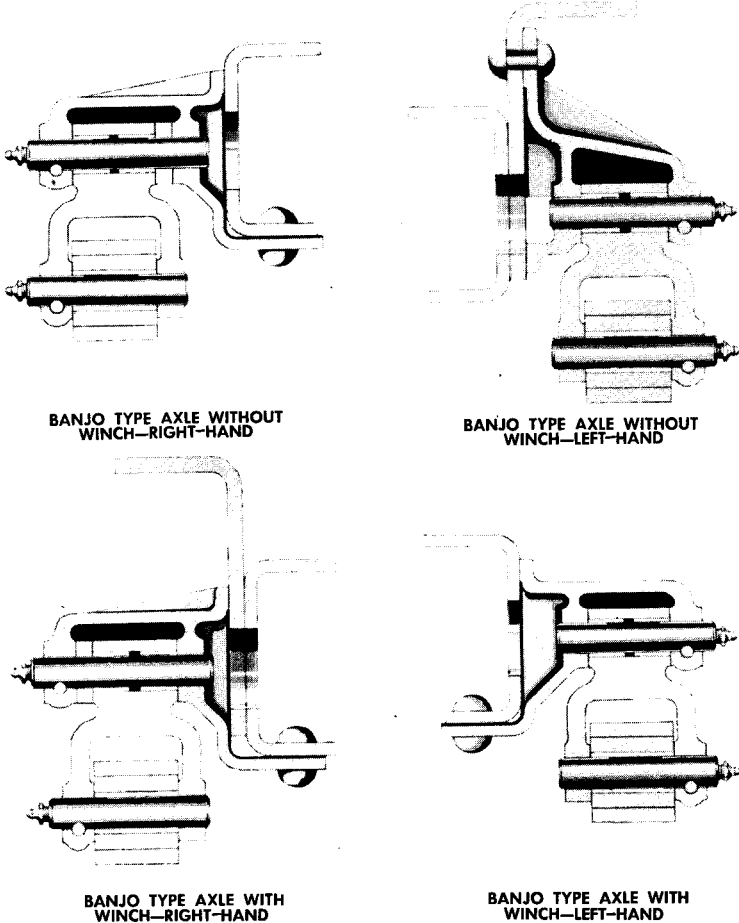

Figure 214—Front Spring Shackles—Banjo Type Axle

RA PD 333052

b. Spring and Shackle Removal (Banjo Type Axles) (figs. 213 and 214). The following procedures are in logical sequence for removing and installing all front springs, spring shackles, and shackle bolts; however, individual parts may be removed and installed separately as necessary.

(1) RAISE FRONT END OF VEHICLE. Jack up front end of vehicle until spring tension is relieved. Block rear wheels to prevent vehicle from rolling.

(2) REMOVE U-BOLTS. Remove all U-bolt nuts, remove U-bolts, shock absorber bracket, and bumper block.

(3) REMOVE SHACKLE AND PINS. Remove shackle pin clamp bolts, and drive out shackle pins. Frame is provided with a hole to facilitate driving out upper pin.

FRONT AND REAR SPRING SUSPENSION

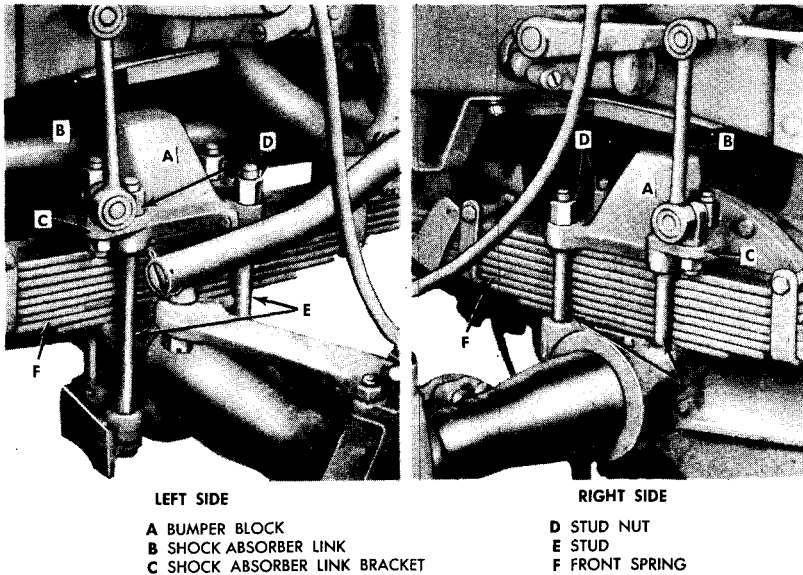

Figure 215—Front Springs Installed—Split Type Axle

RA PD 333053

(4) REMOVE REAR BRACKET BOLT. Remove cotter pin and nut from rear bracket bolt. Drive out bolt and remove spring [with winch (GM-2140052) G508-03-89810; less winch (GM-2140053) G508-03-89792] assembly.

c. Spring and Shackle Installation (Banjo Type Axles) (figs. 213 and 214).

(1) POSITION SPRING. Place spring in position and install rear bracket bolt and nut, draw nut up tight, and install new cotter pin.

(2) INSTALL FRONT SHACKLE. Line up shackle and spacer in front bracket with spacer positioned as necessary (fig. 214), then drive in upper pin. The spacer is used on outer side of right front spring with winch and on inner side of right front spring without winch. Aline hole in spring eye with lower holes in shackle and drive in lower pin. Make sure grooves in pins line up with holes in shackle. Install and tighten clamp bolts, lock washers and nuts.

(3) INSTALL U-BOLTS. Install U-bolts, bumper block, and shock absorber bracket on front springs and axle housing, then install U-bolt nuts. Tighten nuts with torque wrench to 170-185 foot-pounds and remove jack.

d. Spring and Shackle Removal (Split Type Axles) (figs. 215 and 216).

(1) RAISE FRONT END. Jack up front end of vehicle until tension on spring is relieved. Block rear wheels.

(2) REMOVE STUD OR BOLT NUTS. Four studs are used to retain right-hand spring and four bolts are used to retain left-hand

TRUCK, 2 1/2-TON, 6 x 6

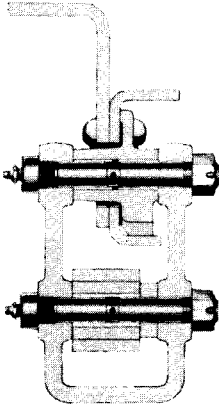

EARLY MODELS WITH
WINCH—RIGHT-HAND

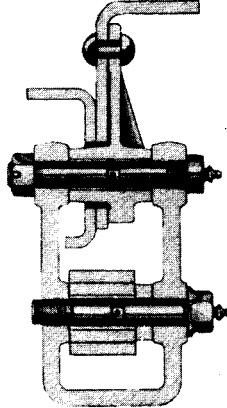

EARLY MODELS WITH
WINCH—LEFT-HAND

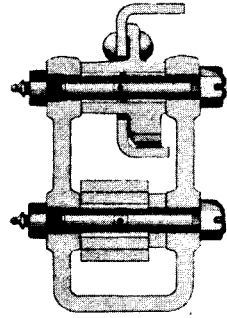

EARLY MODELS WITHOUT
WINCH—RIGHT-HAND

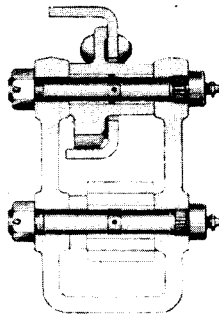

EARLY MODELS WITHOUT
WINCH—LEFT-HAND

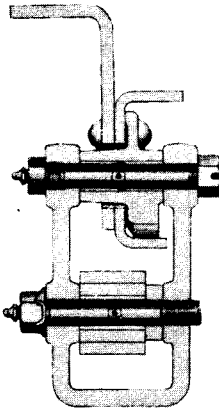

LATE MODELS WITH
WINCH—RIGHT-HAND

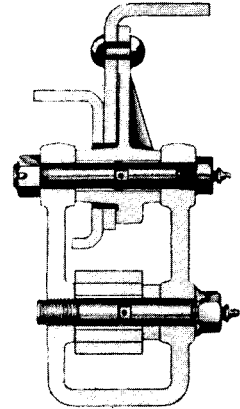

LATE MODELS WITH
WINCH—LEFT-HAND

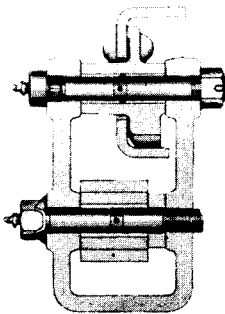

LATE MODELS WITHOUT
WINCH—RIGHT-HAND

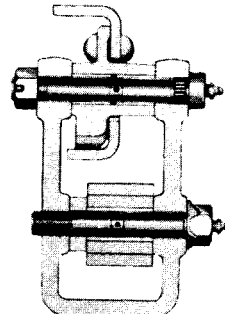

LATE MODELS WITHOUT
WINCH—LEFT-HAND

Figure 216—Front Spring Shackles—Split Type Axle

RA PD 333054

FRONT AND REAR SPRING SUSPENSION

spring. Loosen and remove nuts from either studs or bolts, then remove bumper block and shock absorber bracket.

(3) **REMOVE SHACKLE BOLTS.** Remove the cotter pins and nuts from shackle bolts, then use a lead hammer and a punch to drive out bolts. On the left front spring on early vehicles with winch, and on both front springs on late vehicles with or without winch, the lower bolt must be unscrewed, not driven out. Bend tangs of lock away from hex end of bolt and unscrew bolt.

(4) **REMOVE REAR BRACKET BOLT.** Remove cotter pin and nut from rear bracket bolt, then use a lead hammer and a punch and drive out bolt. Spring assembly [with winch (GM-2140052) G508-03-89810; less winch (GM-2140053) G508-03-89792] may then be withdrawn.

e. **Spring and Shackle Installation (Split Type Axles)** (figs. 215 and 216).

(1) **POSITION SPRING.** Place spring in position. Install rear bracket bolt and nut, draw nut up tight, then install new cotter pin.

(2) **POSITION SHACKLE.** Line up holes in shackle and front bracket, install top bolt, nut, and cotter pin. Line up holes in shackle and front spring and install bottom bolt and spacer. On vehicles equipped with winch, the spacer is installed on inner side of shackle on right-hand spring, while on left-hand spring, the spacer is installed on outer side of shackle. On vehicles without winch, spacers are installed on the inner side on both front springs. Install nut on bolt or thread bolt into shackle, as the case may be (fig. 216), and draw up tight, then back off one-half turn and install cotter pin or bend lock plate against hex end of bolt.

(3) **INSTALL SPRING SEAT BOLTS AND BUMPER BLOCKS.** Install spring seat bolts (left front spring only). Studs are used at right front spring. Make sure that guard is installed on bottom of the two left-hand front bolts. Install bumper blocks, shock absorber

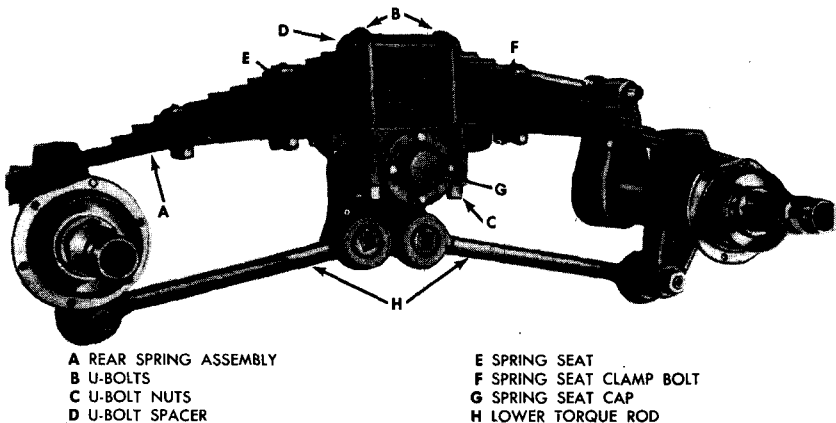

Figure 217—Rear Spring Installed

RA PD 333008

TRUCK, 2½-TON, 6 x 6

brackets, and nuts. Tighten nuts with torque wrench to 170-185 foot-pounds and remove jack.

210. REAR SPRINGS.

a. **Description.** The rear springs are inverted semi-elliptic type (fig. 217) with the center of spring held to the spring seat by two U-bolts. The ends of the spring ride in the spring guide brackets on the axle housings.

b. **Removal** (fig. 217).

(1) **HOIST REAR END OF VEHICLE.** Position jack under cross shaft to frame bracket and jack up vehicle enough to relieve spring tension on side to be serviced. Block wheels to keep vehicle from rolling. Loosen and remove outer wheel nuts (hex), and remove the two outer wheels on side to be serviced.

(2) **REMOVE U-BOLTS.** Loosen and remove U-bolt nuts and spacer. Loosen spring seat clamp bolts.

(3) **REMOVE SPRING FROM VEHICLE.** Force spring off seat, then slide back until front end of spring can be lifted out of bracket on forward rear axle. Raise up front end of spring and pull forward until rear end of spring clears bracket on rearward axle and remove from under vehicle.

c. **Installation** (fig. 217).

(1) **POSITION SPRING.** Place end of spring in bracket on forward rear axle and slide spring forward in bracket until rear of spring will enter bracket on rearward axle and then slide spring toward rear until center bolt drops into recess in spring seat. Make sure spring center bolt is tight. Place U-bolt spacer in position on top of spring.

(2) **INSTALL U-BOLTS.** Insert U-bolts in place with top of U-bolts seated in groove in spacer. Thread nuts on U-bolts and tighten with torque wrench to 200-220 foot-pounds, then tighten spring seat clamp bolts.

(3) **INSTALL WHEELS.** Install wheels and make certain that inner and outer wheel nuts are tight. Lower vehicle to ground and remove jack. Check tightness of spring U-bolts with spring under load.

211. REAR SPRING SEATS.

a. **Description** The rear spring seats are supported on the trunnion cross shaft by tapered roller bearings (fig. 218), which must be lubricated at intervals specified in Section VIII, and inspected and disassembled at intervals indicated in Section XI, if satisfactory spring operation is to be obtained. The bearings must be carefully adjusted upon reassembly.

b. **Check Bearing Adjustment.** Position jack under cross shaft and raise to relieve weight on spring. Remove outer wheels. Then take out U-bolts. Remove spring from spring seat and lower jack under cross shaft. Oscillate spring seat either way while pulling and pushing on seat. If seat oscillates smoothly without perceptible end play or side shake, no further inspection is required and spring can

FRONT AND REAR SPRING SUSPENSION

be reinstalled. If end play or side shake is noticed or if oscillation is jerky, spring seat and bearings have to be removed for further inspection.

c. **Remove Spring Seat** (fig. 218). Remove bearing cap and gasket by removing the four cap screws holding cap to seat assembly. Straighten bent-over portion of nut lock, then remove lock nut, lock adjusting nut, and washer. Remove spring seat together with outer bearing cone and roller assembly, outer and inner bearing cups and seal flange. Lift outer bearing assembly out of spring seat.

d. **Clean and Inspect Bearings and Cups.** Wash bearing cone and roller assemblies and cups thoroughly with dry-cleaning solvent, wipe bearings and cups dry and inspect them carefully. If surfaces of cups or bearing rollers are pitted, they should be replaced. A pitted

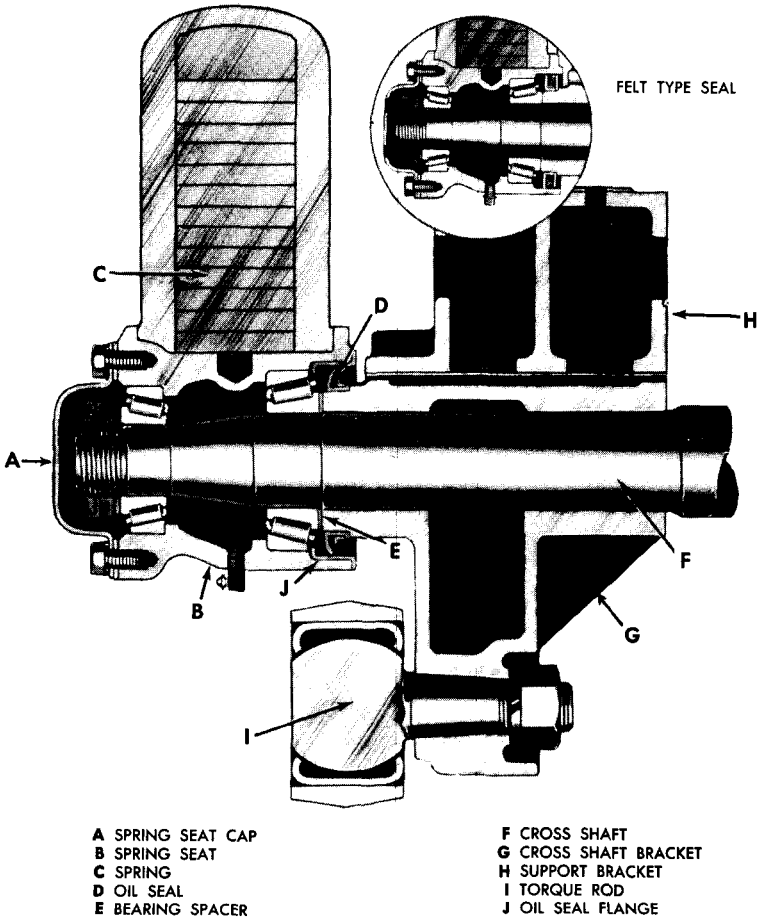

Figure 218—Rear Spring Seat Cross Section

RA PD 333014

TRUCK, 2 1/2-TON, 6 x 6

surface is one in which small particles have broken out, leaving jagged depressions. Bearings used in spring seats roll back and forth as vehicle passes over uneven terrain, but bearing rollers always return to same relative position in cups. In fact, bearing rollers rest in this one position most of the time. Polished lines appear on bearing cups, showing "resting" position of rollers and should not be confused with pitting. These lines are spaced according to distance between line of contact and each roller. These lines are not harmful and bearings should not be replaced unless rough or jerky condition can be felt by rotating bearing roller assembly in race, or if surfaces of cups are actually pitted or broken. If bearing cups or cones are damaged, replace with new parts. Wash seal and seal flange thoroughly. Wipe dry and inspect flange for pitted or worn condition. Check tightness of flange in spring seat. Replace if necessary.

e. Remove Bearing Cups, Inner Bearing, and Seal (If Necessary).

(1) **REMOVE CUPS.** Drive bearing cups out of spring seat, using a punch and hammer. Be careful not to cock cups during removal to prevent damaging the seat. If seat is fitted with a seal flange (used with new lip type seal), this flange must be removed before inner cup can be removed. Remove flange by driving a chisel between flange and seat and prying out.

(2) **REMOVE INNER BEARING AND SEAL.** Remove inner bearing from end of cross shaft. Pry oil seal off shoulder on cross shaft bracket.

f. Install Bearing Cups. Install bearing cups in spring seat with wide edge of cup toward center of seat. Use replacer (41-R-2385-276) to drive outer cup (Timken-2720) firmly against shoulder in seat. Use replacer (41-R-2385-275) to drive inner cup (Timken-3720) against shoulder in seat.

g. Lubricate Bearings. Lubricate bearings as directed in Section VIII.

h. Install Spring Seat, Bearings, and Oil Seal (fig. 218).

NOTE: Two types of oil seals have been used on these vehicles. Early type seal consists of a felt, retainer, and washer. Late type is a lip type seal used with a seal flange. Whenever the spring seat is removed, replace the felt type seal with a new lip type seal, if available. Instructions are also given for installing felt type seal in the event the lip type seal is not available.

(1) **INSTALL SEAL AND BEARING.**

(a) **Lip Type Seal.** Apply a small amount of gasket cement (No. 1) to seal shoulder of cross shaft frame bracket and drive seal against end of shoulder with special replacer (41-R-2397-425). Be sure that cupped side of rubber seal is toward frame. Install bearing spacer on cross shaft. Install bearing cone and roller assembly, using replacer (41-R-2391-30). If seal flange was removed, coat outside of flange sparingly with gasket cement (No. 1) and press into spring seat.

FRONT AND REAR SPRING SUSPENSION

(b) *Felt Type Seal.* Install seal washer, felt, and retainer on cross shaft bracket. Make sure that retainer flange is under felt and away from bearing. Install inner bearing cone and roller assembly, using replacer (41-R-2391-30).

(2) **INSTALL SPRING SEAT.** Fill cavity between inner seal and bearing with lubricant and apply a small amount of lubricant on seal contacting surfaces. Position spring seat on cross shaft end and install outer bearing.

(3) **INSTALL ADJUSTING NUT AND WASHER.** Place adjusting nut washer and adjusting nut (inner) over end of cross shaft. Draw adjusting nut up to approximate adjustment. Spring seat should be oscillated while tightening to prevent grease from being squeezed out from under bearing rollers.

(4) **ADJUST BEARINGS.** Tighten adjusting nut until slight increase in bearing drag over original drag of bearing seal is noticed when seat is oscillated. Lubricate bearings with pressure gun (Section VIII).

(5) **INSTALL BEARING CAP.** When adjusting nut is tightened properly, replace adjusting nut lock and locking nut (outer). Tighten locking nut securely. Test adjustment once more to see that it has

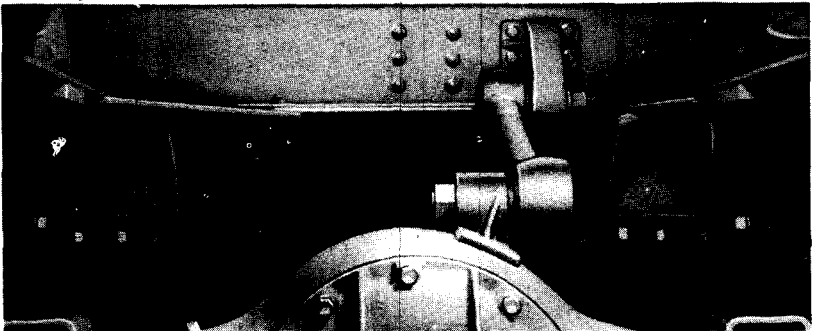

BANJO TYPE AXLE

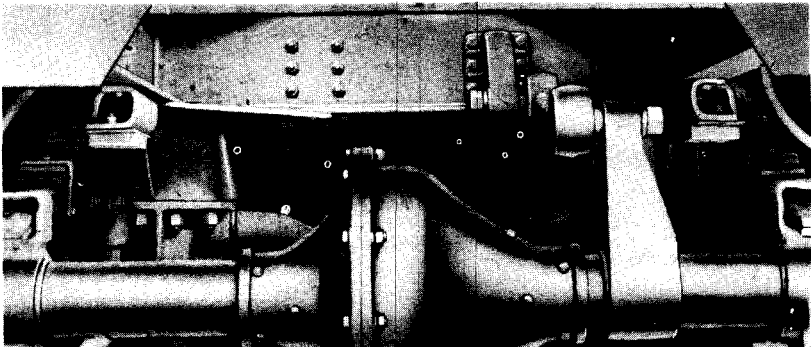

SPLIT TYPE AXLE

Figure 219—Upper Torque Rods Installed

RA PD 332986

TRUCK, 2½-TON, 6 x 6

not been changed and correct if necessary. Bend portion of nut lock over flats of adjusting nut and lock nut. Install the bearing cap and new gasket. Install and tighten the four cap screws and lock washers. Install spring (par. 210 c) and install outer wheels.

212. TORQUE RODS.

a. **Description.** Torque rods, three on each side, interconnect the forward rear (intermediate) axle and the rearward rear axle with the trunnion brackets and frame crossmember (figs. 217 and 219). The ball pin studs at each end of all six torque rods are mounted in special bearings. The torque rods used with split type axles are 1½ inches longer than those used with banjo type axles.

b. **Removal.**

(1) **JACK UP VEHICLE.** Place jack under spring seat and raise until tension is off springs. Remove nuts and lock washers from torque rod pins.

(2) **REMOVE PINS AT EACH END OF TORQUE RODS** (fig. 220). Force torque rod pins out of brackets. To start pins, insert a claw bar between bracket and hub of torque arm. Strike bottom of bracket sharply with heavy hammer while prying with claw bar. Bushing in torque rod will be damaged if excessive force is used with bar.

(3) **REMOVE UPPER TORQUE ROD BRACKETS AT FRAME CROSSMEMBER.** Remove upper torque rod brackets on front and rear of crossmember by removing the six nuts, lock washers, and bolts from each bracket.

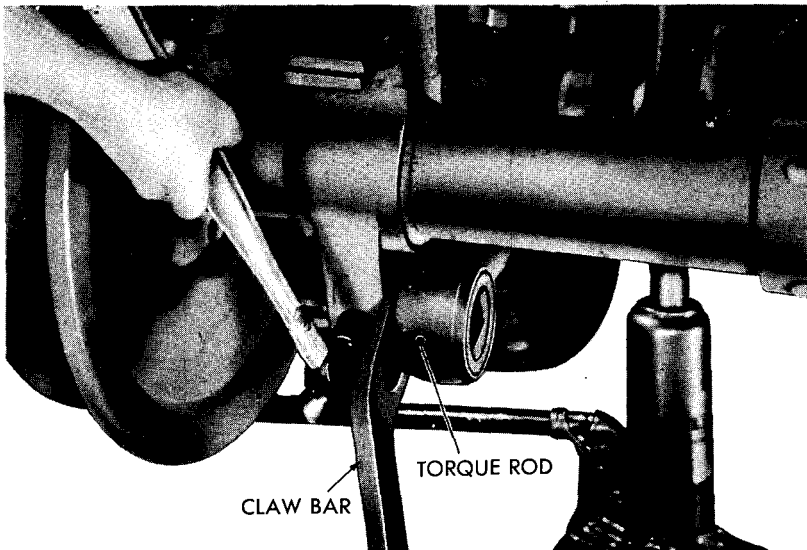

Figure 220—Disconnecting Torque Rod

RA PD 64501

FRONT AND REAR SPRING SUSPENSION

c. Installation.

(1) **INSTALL UPPER TORQUE ROD BRACKETS AT FRAME CROSS-MEMBER (SPLIT TYPE AXLES).** Brackets at frame crossmember for upper torque rods for split type axles are identical and either can be used at front or rear of crossmember. Position brackets on frame crossmember and insert the six attaching bolts, then install and tighten lock washers and nuts.

(2) **INSTALL UPPER TORQUE ROD BRACKETS AT FRAME CROSS-MEMBER (BANJO TYPE AXLES).** Brackets for upper torque rods for banjo type axles are not interchangeable. Bracket attached to front of crossmember must be installed with large end of taper toward left side of frame. Bracket at rear of crossmember must also be installed with large end of taper toward left side of frame. Position brackets on frame crossmember and insert the six attaching bolts, then install lock washers and nuts. Tighten nuts securely.

(3) **INSTALL TORQUE RODS.** Clean all grease and dirt from torque rod pins, and see that bushings are clean and free from dirt. The two lower torque rods on each axle should be installed before top torque rods are installed. Force torque rod pin firmly into brackets, using a block of wood and hammer, and then install lock washers and nuts. Tighten securely. Lower and remove jacks.

213. SHOCK ABSORBERS.

a. **Description.** The shock absorbers, mounted on the outer side of the frame over the front axle, are used at the front end only (figs. 213 and 215).

b. **Removal.** Remove nut and lock washer from eye bolt and lift eye bolt out of bracket at spring. From inside frame, remove two nuts, lock washers, and flat washers from shock absorber to frame bolts and remove shock absorber, link, and eye assembly. Remove nut from tapered stud at each end of link, remove eye bolt from link, and remove link from shock absorber arm.

c. **Installation.** Install eye bolt on tapered stud in end of link and install nut. Insert tapered stud in other end of link through shock absorber arm and install nut. Tighten nuts firmly. Install two bolts through shock absorber and frame, install two flat washers, lock washers, and nuts on bolts and tighten firmly. Insert eye bolt through bracket at spring, install nut and lock washer and tighten.

d. **Check and Replenish Fluid.** Clean shock absorber thoroughly, then remove filler plug and check level of fluid. If fluid is below level of filler plug hole, additional fluid must be added. Remove nut and lock washer attaching lower end of link to eye bolt and pull tapered stud out of eye bolt. Fill shock absorber with fluid (Section VIII) and replace filler plug. Move shock absorber arm up and down several times to work fluid into piston cylinder. Remove filler plug and add more fluid. To provide necessary air space in shock absorber, allow fluid to drain down to the level of filler plug hole, then install filler plug with new gasket.

TRUCK, 2 1/2-TON, 6 x 6
Section XXXVIII

FRAME

214. DESCRIPTION.

a. **General.** The frame is composed of steel channel section side rails to which steel gussets, brackets, and crossmembers are riveted. Other attachments such as fuel tank brackets, battery box, step hangers, bumpers, and tire carrier are bolted in place.

b. **Frame Alinement.** Since the frame constitutes the "foundation" of the entire vehicle, proper functioning of the vehicle and its components is greatly dependent upon correct frame alinement. If vehicle has been in a collision, or if there is any reason to suspect a sprung, swayed, or otherwise misaligned frame, report condition immediately to proper authority.

c. **Checking Procedure** (fig. 221). The most convenient way to check frame alinement, particularly on trucks equipped with a body, is by marking on the floor all points from which measurements are to be taken. This can be done by tacking or cementing pieces of paper securely to the floor under each point of measurement. Starting at "M," indicated on figure 221, drop a "plumb bob" from each point. Satisfactory checking is dependent upon accuracy of marks with relation to the frame. After each point shown has been marked carefully and the vehicle moved away from the layout on the floor, proceed as directed in the following steps.

(1) Check frame width at front and rear ends, using corresponding marks on floor. If widths correspond to specifications given, draw center line full length of vehicle halfway between marks indicating front and rear widths. If frame width is not correct, lay out center line as directed in step (4) below.

(2) With center line properly laid out, measure distance from it to opposite points marked over entire length of chassis. If frame is in proper alinement, measurements should not vary more than 1/8 inch at any point.

(3) To locate point at which frame is sprung, measure diagonals marked A, B, and C. If diagonals in each pair are within 1/8 inch, that part of frame included between points of measurements may be considered in alinement, and these diagonals should intersect within 1/8

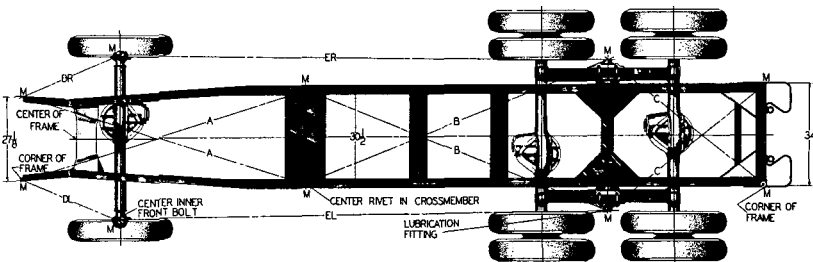
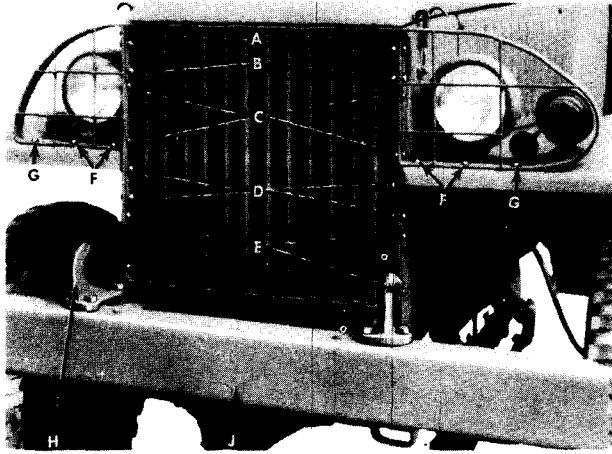

Figure 221—Frame Alinement Check Points

RA PD 64584

FRAME



RADIATOR BRUSH GUARD, BUMPER, AND TOW HOOKS

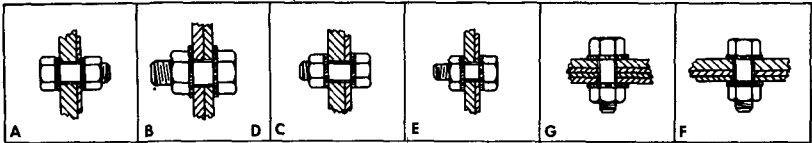

SECTIONS OF TOOTHED LOCK WASHER MOUNTINGS

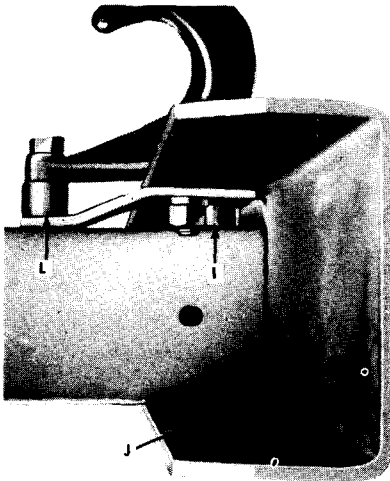

FRONT BUMPER (WITHOUT WINCH)

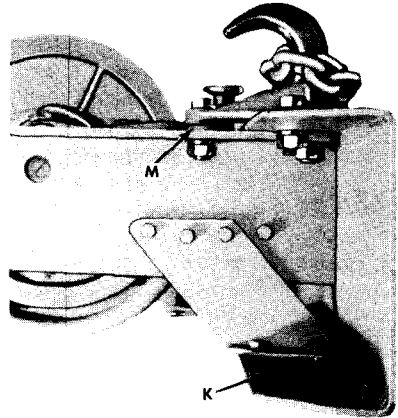

FRONT BUMPER (WITH WINCH)

- A GUARD TO HOOD SIDE PANEL
- B GUARD TO RADIATOR SUPPORT
- C GUARD TO HOOD SIDE PANEL
- D GUARD TO RADIATOR SUPPORT
- E GUARD TO FENDER SKIRT
- F GUARD TO FENDER
- G GUARD TO FENDER

- H FRONT TOW HOOK
- I SPACER ($1\frac{1}{16}$ INCH)
- J FRONT BUMPER (WITHOUT WINCH)
- K FRONT BUMPER (WITH WINCH)
- L SPACER ($1\frac{5}{16}$ INCH)
- M SPACER ($1\frac{1}{4}$ INCH)

RA PD 332948

Figure 222—Front Bumper, Tow Hooks, and Brush Guard

TRUCK, 2½-TON, 6 x 6

inch of center line. Variations of more than ⅛ inch indicate misalignment.

(4) If center line cannot be laid out from points at ends of frame, it can be drawn through intersection of any one pair of diagonal lines of equal length and center point of either end of frame. Center line can also be laid out through points of intersection of any two pairs of equal diagonals. If extreme front end or horn of frame is damaged, center of front end of frame can be located from point exactly midway between radiator support bolts.

(5) After it has been determined that frame is properly aligned, front axle alignment with frame can be checked as directed below (fig. 221).

(a) Front axle is square with frame if ER equals EL, and DR equals DL.

(b) Front axle has shifted sideways if ER is less than EL, and DR less than DL, or vice versa.

(c) Front axle is bent, twisted, or shifted if ER is less than EL and DR is greater than DL, or vice versa.

215. BUMPERS.

a. **Rear Bumpers** (fig. 224). Two rear bumpers (bumperettes) are formed from steel plate and are attached to each frame rear corner.

(1) **REAR BUMPER REMOVAL.** Remove eye bolt and hex-head bolt attaching bumper to rear crossmember. Remove four bumper to side rail bolts then remove bumper. Removal operations are same for either right- or left-hand side.

(2) **REAR BUMPER INSTALLATION.** Position bumper on frame, using drifts to aline holes. Install bolts, nuts, and washers, locating eye-bolt as in figure 224, then tighten all nuts firmly. Installation is same for either bumper.

b. **Front Bumpers** (fig. 222). Front bumper, used on models without winch, is a pressed steel channel, bolted to front ends of frame side rails. For models with winch, a similar, but wider bumper with a cutout in lower center section is attached to frame extension with bolts and brackets.

(1) **MODELS WITHOUT WINCH.**

(a) **Removal.** Remove two bolts, nuts, and washers at front end of each tow hook then remove short spacers from between bumper gusset and side rail. Loosen each rear tow hook bolt nut and swing tow hooks to rear. Remove two bolts, nuts, and washers from top flange of bumper, remove two bolts, nuts, and washers from lower flange of bumper, then lift bumper off side rails.

(b) **Installation.** Position bumper on side rails with the short ($\frac{11}{16}$ in.) spacers between side rails and bumper gussets, then swing tow hooks into position. Install two bolts in each tow hook, then install washers and nuts loosely. Install two bolts attaching bumper upper flange to gusset, then install washers and nuts loosely. Install two bumper lower flange to side rail bolts, and install washers and nuts loosely. Tighten all nuts, including tow hook rear nuts, firmly.

FRAME

(2) MODELS WITH WINCH.

(a) *Removal.* Unhook winch chain from tow hooks, then remove two bolts, nuts, and washers at front of each tow hook. Loosen nut on each rear tow hook bolt and swing tow hooks to rear. Remove two bolts, nuts, and washers attaching bumper lower flange to bumper brackets, then remove four bumper upper flange to winch angle bolts and washers. Lift bumper off frame extensions.

(b) *Installation.* Position bumper on frame extensions, swing tow hooks forward, and align holes with drifts. Loosely install four bolts with washers through bumper upper flange into winch angle. Install two bolts, nuts, and washers attaching bumper lower flange to each bumper bracket, then tighten all bolts and nuts firmly, including tow hook rear bolt nuts. Hook chain on tow hooks and engage winch to pull chain taut.

216. TOW HOOKS.

a. **Front Tow Hooks** (fig. 222). A right-hand and a left-hand tow hook is bolted to front end of frame side rails on models without winch, and to ends of frame extension on vehicles equipped with winch.

(1) MODELS WITHOUT WINCH.

(a) *Removal.* Remove three bolts, nuts, and washers, and two spacer attaching tow hook, then remove tow hook. Removal operation is same for either side.

(b) *Installation.* Position $1\frac{1}{16}$ -inch long spacer between side rail and bumper gusset then position tow hook with $1\frac{5}{16}$ -inch long spacer under hook rear bolt hole. Install three bolts, nuts, and washers and tighten nuts firmly. Installation is same for either side.

(2) MODELS WITH WINCH.

(a) *Removal.* Remove three bolts, nuts, and washers, and one spacer attaching tow hook, then remove tow hook. Removal operation is applicable to either side.

(b) *Installation.* Position tow hook with $\frac{1}{4}$ -inch long spacer under hook rear bolt hole, then install three bolts, nuts, and washers, tightening nuts firmly. Operation is same for either side.

b. **Rear Tow Hooks.** Rear tow hooks are used only on vehicles equipped with water tank or gasoline tank bodies. One tow hook is bolted to side of each frame side rail near rear crossmember.

(1) **REMOVAL.** Remove three bolts, nuts, and washers, and one spacer, then remove rear tow hook. Removal is same for either side.

(2) **INSTALLATION.** Position tow hook on frame side rail with spacer under hook front bolt hole, install three bolts, nuts, and washers, and tighten nuts firmly. Installation operation is same for either side.

217. BRUSH GUARD.

a. Brush guard, made of steel rods and bars integrally welded to a rigid frame, protects radiator core, headlights, and blackout lights from damage. Guard also serves to reinforce front end sheet metal

TRUCK, 2½-TON, 6 x 6

by tying together fenders, radiator support, and hood side front panels.

b. On vehicles equipped with radio suppression it is important that attaching bolts be kept tightened to suppress radio interference noise.

c. **Brush Guard Removal.** Remove three bolts, nuts, and washers attaching each fender to guard (F and G, fig. 222). Remove five bolts, nuts, and washers attaching sheet metal to each side of brush guard (A, C, and E, fig. 222). Remove four bolts, nuts, and washers attaching radiator supports to each side of brush guard (B and D, fig. 222), then pull brush guard forward and remove from vehicle.

d. **Radio Noise Suppression.** Figure 222 shows location of all brush guard attaching bolts together with sectional views of bolts installed. The internal-external toothed lock washers must be used on each bolt, one under bolt head, the other under the nut, to prevent electrical radiation.

e. **Brush Guard Installation.** Position brush guard on vehicle, and align bolt holes with drift. Install four bolts and nuts, and eight internal-external toothed lock washers attaching each side of brush guard to radiator supports (B and D, fig. 222). Install the 10 internal-external toothed lock washers, and five bolts and nuts attaching sheet metal to each side of brush guard (A, C, and E, fig. 222). Install six internal-external toothed lock washers, and three nuts and bolts attaching each fender to brush guard (F and G, fig. 222). Tighten all mounting nuts firmly.

218. SPARE WHEEL CARRIERS.

a. Three types of wheel carriers are used; the type used being dependent on wheelbase and body. The 164-inch wheelbase (model CCKW-353) with cargo or dump body has single wheel carrier mounted on left side rail back of cab and under cargo body (fig. 223). The 145-inch wheelbase (model CCKW-352) with cargo body mounts two wheels and tires vertically between cab and body. Fuel tank and tank support forms the base for this carrier (fig. 223). The 164-inch wheelbase (model CCKW-353) with tank bodies carries a single wheel and tire in vertical position between cab and tank (fig. 223).

b. Long-wheelbase—Cargo Body.

(1) **SPARE WHEEL CARRIER REMOVAL** (fig. 223). Remove lock, then remove nut from carrier to frame stud. Lift latch handle and swing wheel down, remove two spare wheel hub nuts, then remove wheel. Remove the six bolts, nuts, and washers attaching carrier brackets to frame, then remove carrier from frame.

(2) **SPARE WHEEL CARRIER INSTALLATION** (fig. 223). Position carrier assembly on frame and align bolt holes with drifts. Install six mounting bolts, nuts, and washers, then tighten nuts firmly. Position spare wheel over two studs, install two hub nuts, and tighten nuts firmly. Lift wheel to horizontal position and engage latch. Install stud nut and tighten firmly, then install lock.

FRAME

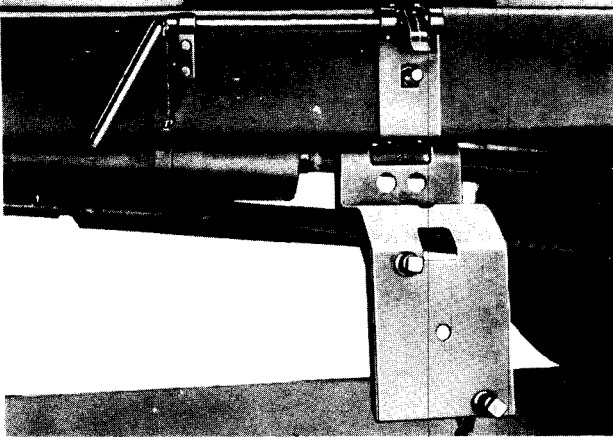

TIRE CARRIER (164-INCH WHEELBASE WITH CARGO OR DUMP BODIES)

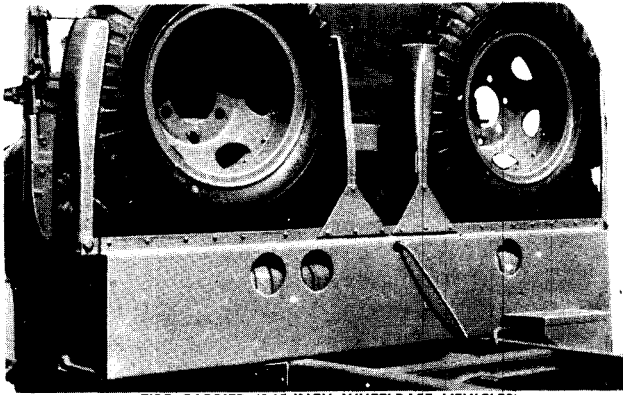

TIRE CARRIER (145-INCH WHEELBASE VEHICLES)

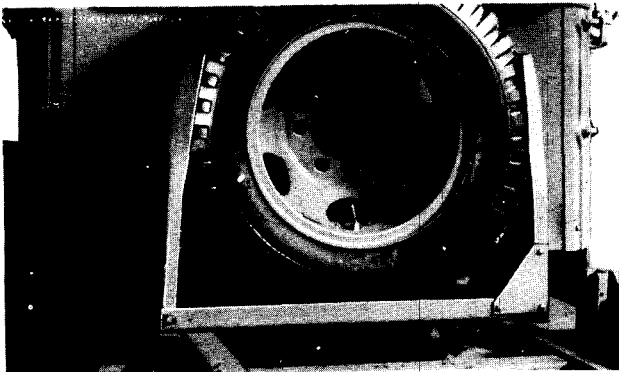

TIRE CARRIER (164-INCH WHEELBASE WITH TANK BODIES)

Figure 223—Spare Wheel Carriers

RA PD 332994

TRUCK, 2 1/2-TON, 6 x 6

c. Short-wheelbase—Cargo Body.

(1) **SPARE WHEEL CARRIER REMOVAL** (fig. 223). *NOTE: Spare wheel carrier support encloses the fuel tank which may be removed from carrier support either before or after removal of carrier from vehicle.* If necessary to remove fuel tank, refer to paragraph 100 for removal. Remove cargo racks from body, remove locks from carrier, then remove clamp nuts from clamp bolts. Swing clamps down, remove nuts from wheel hubs, then lift wheels from carrier. Remove both drain plugs from tank and drain tank completely. Remove 11 bolts, nuts, and washers attaching carrier to frame side rails. Disconnect fuel gage wire at tank, then unscrew fuel line nut at tank and disconnect fuel line. Withdraw gage wire and fuel line from tire carrier support, shifting tank and carrier forward on side rails, if necessary for clearance. Lift carrier and tank unit straight up to remove from vehicle.

(2) **SPARE WHEEL CARRIER INSTALLATION** (fig. 223). Position carrier on frame side rails and connect fuel gage wire and fuel line, shifting carrier forward or back as necessary to make connections. Aline mounting bolt holes, install 11 carrier to frame bolts, nuts, and washers, and then tighten nuts firmly. Position wheels in carrier and install one nut at hub of each wheel. Swing clamp up against tires, install and tighten clamp nuts on clamp bolts, then install locks. Install drain plugs, then install cargo racks on body.

d. Long-wheelbase—Tank Bodies.

(1) **SPARE WHEEL CARRIER REMOVAL** (fig. 223). Remove spare wheel lock, remove clamp nut and swing clamp down, then remove spare wheel. Remove eight bolts, nuts, and washers attaching carrier to frame side rails and lift carrier off chassis.

(2) **SPARE WHEEL CARRIER INSTALLATION** (fig. 223). Position carrier on vehicle and aline mounting bolt holes with drifts. Install eight carrier to frame bolts, nuts, and washers, and tighten nuts firmly. Position wheel and tire in carrier and swing clamp up against tire. Install and tighten clamp nut, then install lock.

219. PINTLE HOOK.

a. Pintle hook is mounted at center of rear crossmember with front end of pintle supported by a steel channel. A heavy coil spring in the assembly serves to absorb shocks in starting and towing. Keep pintle shaft nut tight enough to eliminate rattles and lubricate moving parts periodically with seasonal grade engine oil. Pintle hooks are not used on vehicles equipped with water or gasoline tank bodies.

b. **Pintle Hook Removal** (fig. 224). Remove six bolts, nuts, and washers attaching pintle hook front support to braces. Remove cotter pin and remove nut from pintle shaft. Slide support, spring, and sleeves from pintle shaft and pull shaft out through rear crossmember.

c. **Pintle Hook Installation** (fig. 224). Insert pintle shaft through rear crossmember and assemble spring and sleeves on shaft

FRAME

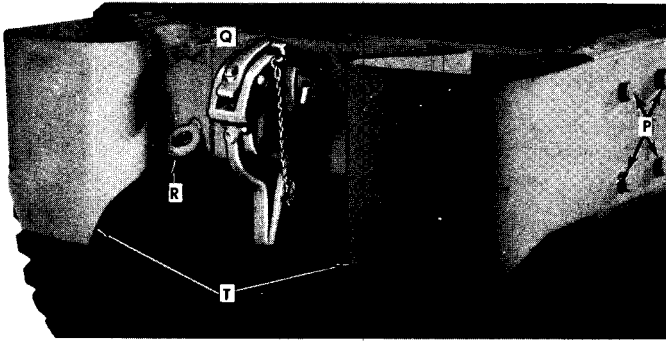

REAR BUMPER AND PINTLE HOOK

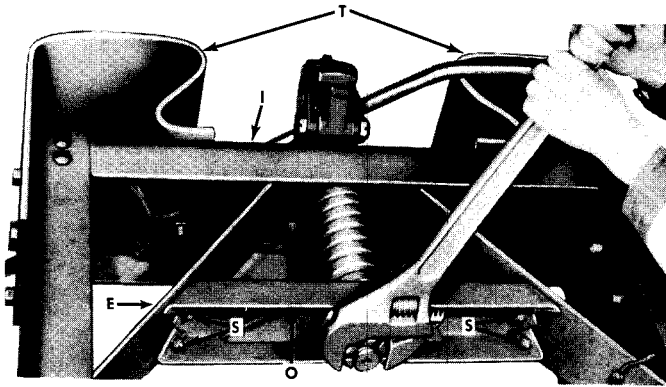

ADJUSTING PINTLE HOOK SPRING TENSION

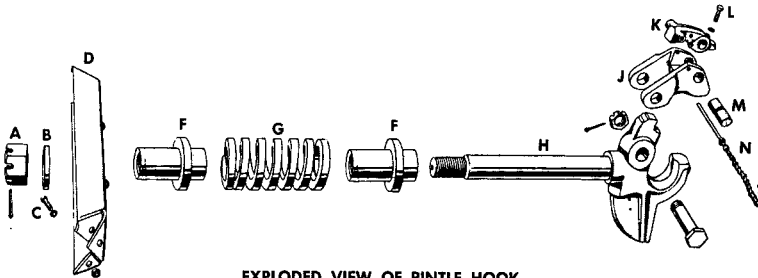

EXPLODED VIEW OF PINTLE HOOK

- A NUT
- B WASHER
- C BOLT
- D FRONT SUPPORT
- E BRACE
- F SLEEVE
- G SPRING
- H HOOK
- I REAR CROSSMEMBER
- J LOCK

- K LATCH
- L SCREW
- M PIN
- N CHAIN
- O SUPPORT
- P BUMPER TO SIDE RAIL BOLT
- Q BUMPER TO CROSSMEMBER BOLT
- R EYE BOLT
- S SUPPORT TO BRACE BOLT
- T BUMPER

RA PD 332947

Figure 224—Pintle Hook and Rear Bumper

TRUCK, 2 1/2-TON, 6 x 6

with sleeves positioned as in figure 224. Reversing either sleeve will make assembly too long or too short to properly install on vehicle; reversing both sleeves will result in extending hook 1 3/4 inches back from rear crossmember. Place pintle support over shaft against sleeve shoulder, install washer, and start pintle shaft nut. Insert suitable bar through pintle hook eye to prevent hook turning while tightening nut. Tighten shaft nut until support fits up against frame brace, then attach support to brace with six bolts, nuts, and washers. Adjust nut to provide just enough spring tension to prevent rattle, then secure nut with new cotter pin.

Section XXXIX

CAB AND ASSOCIATED PARTS

220. GENERAL.

a. Cab consists of an open top structure enclosing driver's compartment. The cab, of all steel construction, consists of cowl and dash panel, side panels, rear panel, seat risers, and floor pan bolted together into a unit assembly. Weather protection is provided by windshield, top deck, rear curtain, and hinged side curtains. Cab is equipped with an inside and an outside rear view mirror (head—GM-2165013), two windshield wipers, two rifle holders, and includes provision for gun mount ring.

221. CAB MOUNTINGS.

a. **Description.** Three-point type mounting, shown in figure 225, is used to attach the cab to the chassis frame. Both front corners of the cab are flexibly mounted by means of a mounting cushion between the cab and frame mounting bracket. Rear mounting consists of a single through bolt and cushions at rear center of the cab which fastens the cab to the frame cross channel. A heavy cushion spring is mounted between cab and frame cross channel at each side of the rear center mounting bolt to prevent excessive rocking movement of the cab.

b. **Mounting Adjustment.** Any change in the position of the cab in relation to the chassis frame may cause steering gear to bind (par. 204) and may change the clearance between radiator and fan (par. 109). Steering gear and cab mounting tightening procedures must be performed together and procedure must be followed in sequence given if correct mounting is to be obtained.

(1) **LOOSEN STEERING COLUMN BRACKET.** Loosen two nuts attaching steering column bracket at lower edge of dash panel.

CAB AND ASSOCIATED PARTS

(2) **LOOSEN STEERING GEAR FRAME MOUNTING BOLTS.** Loosen, but do not remove, four bolt nuts attaching steering gear housing flange to frame left side rail.

(3) **ADJUST CAB MOUNTINGS.** Loosen all three cab mounting bolts (fig. 225). Inspect mountings and replace any damaged parts as described in subparagraphs c and d below. Move cab into correct position to locate squarely at all three mounting points on chassis. Tighten adjusting nut and lock nut on each of three mounting bolts, being sure not to change position of cab. Do not use lubricant on bolts and nuts.

(4) **CHECK AND ADJUST RADIATOR MOUNTINGS AND CLEARANCE.** Check radiator to fan clearance and adjust radiator mountings if necessary, as described in paragraph 109.

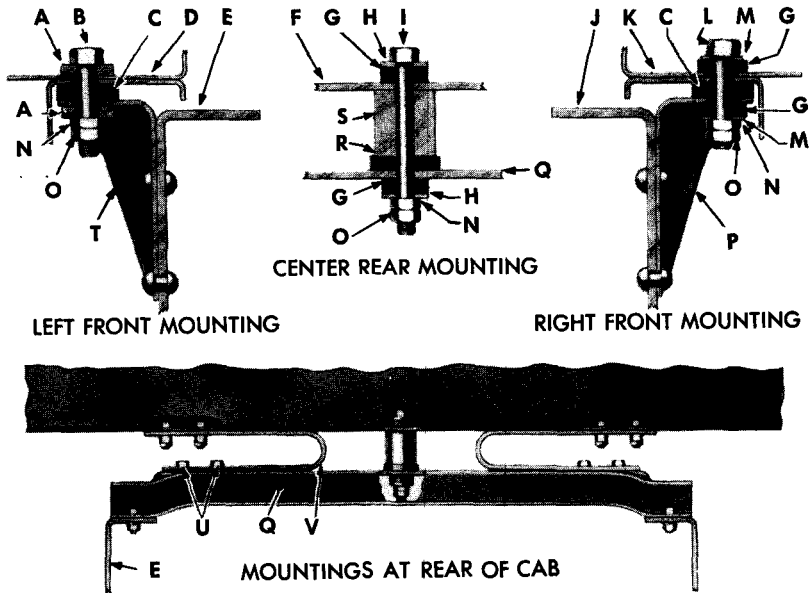

- | | |
|---|---------------------------------------|
| A STEEL SPACER | L RIGHT FRONT MOUNTING BOLT |
| B LEFT FRONT MOUNTING BOLT | M STEEL WASHER |
| C LEFT AND RIGHT FRONT MOUNTING CUSHION | N ADJUSTING NUT |
| D LEFT FRONT CORNER OF CAB | O LOCK NUT |
| E FRAME LEFT SIDE RAIL | P RIGHT FRONT FRAME BRACKET |
| F CAB REAR FLOOR | Q FRAME CROSS CHANNEL |
| G CENTER REAR AND RIGHT FRONT MOUNTING CUSHION | R CENTER REAR MOUNTING CUSHION |
| H STEEL WASHER | S CENTER REAR STEEL SPACER |
| I CENTER REAR MOUNTING BOLT | T LEFT FRONT FRAME BRACKET |
| J FRAME RIGHT SIDE RAIL | U REAR MOUNTING SPRING BOLTS |
| K RIGHT FRONT CORNER OF CAB | V REAR MOUNTING SPRING |

Figure 225—Cab Three-Point Mounting

RA PD 64723

TRUCK, 2½-TON, 6 x 6

(5) **ADJUST STEERING GEAR AND TIGHTEN MOUNTINGS.** Check steering gear adjustments and tighten steering gear mountings, as described in paragraph 204. Tighten two U-bolt nuts attaching steering column to lower edge of dash panel. Tighten four steering gear housing flange to frame side rail bolts, tightening upper front or pivot bolt last. Turn steering wheel to extreme right and left positions, and if any binding is evident, repeat above operations so that steering gear and cab mountings can be tightened without causing binding.

c. Mounting Removal. Removal operations cover only removal of the three cab mounting bolts, cushions, and spacers.

(1) **REMOVE CAB LEFT FRONT MOUNTING BOLT.** Pry up access hole button plug from left side of cab floor. Remove lock nut, adjusting nut, and steel spacer from end of bolt accessible under cab skirt above left-hand running board. From inside cab, remove mounting bolt and steel spacer at access hole in cab floor. Raise corner of cab to relieve pressure on mounting cushion and withdraw cushion from between cab and frame bracket.

(2) **REMOVE CAB RIGHT FRONT MOUNTING BOLT.** Pry up access hole button plug from right side of cab floor. Remove lock nut, adjusting nut, washer, and mounting cushion from end of bolt accessible under cab skirt above right-hand running board. From inside cab, remove bolt, washer, and mounting cushion at access hole in cab floor. Raise corner of cab to relieve pressure on mounting cushion and withdraw cushion from between cab and frame bracket.

(3) **REMOVE CAB REAR CENTER MOUNTING BOLT.** From underneath vehicle at frame cross channel, remove lock nut, adjusting nut, washer, and mounting cushion from end of bolt. Remove two nuts, washers, and bolts attaching one mounting spring to frame cross channel. From inside cab, remove rear center mounting bolt, washer, and mounting cushion. Raise the rear corner of cab at which spring bolts were removed and withdraw mounting cushion and steel spacer.

d. Mounting Installation.

(1) **INSTALL CAB REAR CENTER MOUNTING BOLT.** Raise the rear corner of cab at which spring bolts were removed and position mounting cushion and steel spacer (fig. 225) and align holes. Lower cab corner so cab rests on spacer above cushion. Install washer and mounting cushion on bolt, then insert bolt through cab floor, steel spacer, mounting cushion, and frame cross channel. Install two bolts, nuts, and washers through mounting spring and frame cross channel. Install mounting cushion, washer, and adjusting nut on end of rear mounting bolt, tightening nut firmly, then install and tighten lock nut.

(2) **INSTALL CAB RIGHT FRONT MOUNTING BOLT.** Raise right front corner of cab and insert mounting cushion between cab and frame mounting bracket, align holes in cab, cushion, and bracket, then lower corner of cab. Install flat washer and cushion on mounting bolt and insert bolt through cab, mounting cushion, and frame bracket from inside cab. Install mounting cushion, flat washer, and adjusting nut on mounting bolt from under cab skirt above right

CAB AND ASSOCIATED PARTS

running board. Tighten nut firmly, install lock nut and tighten. Install button plug in cab floor.

(3) **INSTALL CAB LEFT FRONT MOUNTING BOLT.** Raise left front corner of cab, insert mounting cushion between cab and frame bracket, aline holes, then lower cab. Install steel spacer on bolt and insert bolt through cab, cushion, and frame bracket from inside of cab. Install steel spacer and adjusting nut from under cab skirt above left-hand running board. Tighten nut firmly and install and tighten lock nut. Install button plug in cab floor.

222. WINDSHIELD.

a. **Description.** Windshield consists of the windshield frame and glass assembly hinged to windshield tubular support frame at the top edge by interlocking metal strips. Tubular support frame pivots at the lower corners on pins in brackets, bolted to the cab cowl at the front corners of the driver's compartment.

b. **Windshield Removal** (fig. 226). Windshield frame assembly can be removed without loosening or removing tubular support frame.

(1) **DISCONNECT ADJUSTING ARMS AT BRACKETS.** Loosen adjusting arm (upper) knobs, open windshield, then tighten knobs to hold windshield tilted open. Remove two adjusting arm to bracket screws and disengage arms from brackets.

(2) **REMOVE WINDSHIELD WIPER MOTORS.** Remove wiper motors as described in paragraph 223.

(3) **REMOVE WINDSHIELD FRAME AND GLASS ASSEMBLY.** Bend open one end of tubular frame hinge strip with screw driver (fig. 226). Open windshield wide and slide frame and glass assembly endwise sufficiently to completely disengage interlocking hinge strips.

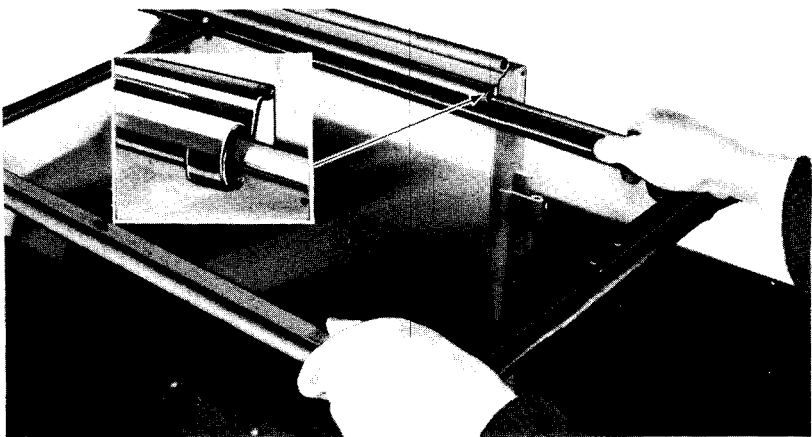

Figure 226—Windshield Frame and Glass Removal

RA PD 64733

TRUCK, 2 1/2-TON, 6 x 6

c. Windshield Installation.

(1) HINGE WINDSHIELD TO FRAME. Hold windshield frame and glass in horizontal position and engage end of strip with opened end of hinge strip on tubular support frame. Slide frame and glass to

proper position and close windshield. Bend opened end of tubular frame hinge strip to lock windshield in place laterally.

(2) CONNECT ADJUSTING ARMS. Open windshield sufficiently to position adjusting arms on windshield brackets. Install screw and tighten to connect each arm to bracket.

(3) INSTALL WINDSHIELD WIPER MOTORS. Install both wiper motors as described in paragraph 223.

223. WINDSHIELD WIPERS.

a. Description. Two identical vacuum operated windshield wipers are mounted at top of the left and right sections of the windshield. Wipers are connected to engine manifold by means of tubing and hose. Each wiper consists of a wiper motor, arm, and blade.

b. Windshield Wiper Removal (fig. 227). Procedure is same for either motor.

(1) DISCONNECT HOSE. Pull vacuum line hose loose from wiper motor.

(2) REMOVE BLADE AND ARM. Remove nut [(GM-3661579) G501-03-14861] from end of wiper motor shaft and pull wiper arm (GM-2198557) and blade (GM-2198558) as an assembly from motor shaft.

(3) REMOVE WINDSHIELD WIPER MOTOR. At front side of windshield, remove the two screws attaching motor [(GM-2180781)

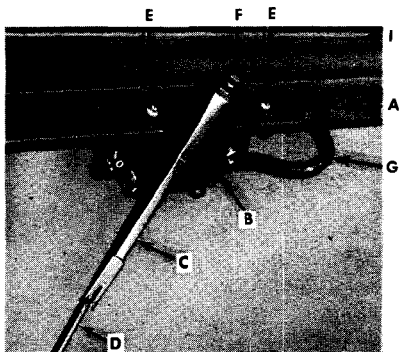

WINDSHIELD WIPER MOUNTED

- A WINDSHIELD CROSSPIECE
- B WIPER MOTOR
- C WIPER ARM

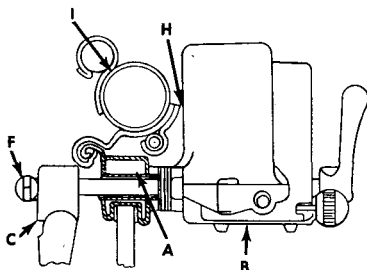

WIPER AND TUBULAR FRAME CLEARANCE

- F ARM NUT
- G VACUUM HOSE
- H CLEARANCE

CAB AND ASSOCIATED PARTS

G501-02-95848] to windshield frame. Pull motor loose from rear of windshield.

c. **Windshield Wiper Installation** (fig. 227). Procedure is the same for either motor.

(1) **INSTALL WINDSHIELD WIPER MOTOR.** Insert motor shaft through hole in windshield frame from rear side of windshield. Install two screws from front side of windshield to attach motor to windshield frame.

(2) **CHECK MOTOR CLEARANCE.** With windshield fully closed there should be some clearance between windshield wiper motor and the windshield tubular frame as shown in figure 227. If this clearance is not present, correct as follows:

(a) Remove wiper motor as directed in subparagraph b (3) above.

(b) Redrill wiper shaft hole in windshield frame, using a $\frac{7}{16}$ -inch diameter drill or file or ream out original hole. Hole must be straight through windshield to permit installation of motor without distortion of shaft and sleeve.

(c) Reinstall motor as described in step (1) above, and recheck for clearance.

(3) **INSTALL WIPER ARM AND BLADE.** Install wiper arm and blade as an assembly on end of motor shaft, then install and tighten shaft to arm nut. Connect vacuum line hose to wiper motor.

d. **Wiper Blade Replacement.** Procedure is the same for either blade.

(1) **REMOVE BLADE.** Hold lower end of wiper arm away from windshield with one hand; with the other, pull lower end of blade outward and upward until blade is in contact with front of arm. Pull end of blade farthest from motor shaft away from motor shaft to remove blade from arm.

(2) **INSTALL BLADE.** With hook on blade pointing to motor shaft, and with metal part of blade in contact with forward side of arm, push blade toward shaft. Pull lower end of arm away from windshield with one hand; with the other hand, pull end closest to motor shaft outward and downward to engage blade hook in slot in arm.

224. SEATS (fig. 228).

a. **Description.** Cab seats consist of individual seats for the driver and the assistant driver. The seats are similar and are mounted on a seat riser which is bolted to the cab floor. Seat backs are hinged to lay forward on seats, while seats can also be tilted up against seat backs. A sector arm, attached to right-hand seat only, permits locking seat in upright position. Raising bottom of driver's seat affords access to stowage compartment under seat.

b. Seat Removal.

(1) **REMOVE SEAT CUSHIONS.** Pull bottom of seat back cushion forward, then tilt seat back down. Slide cushion to side to disengage

TRUCK, 2½-TON, 6 x 6

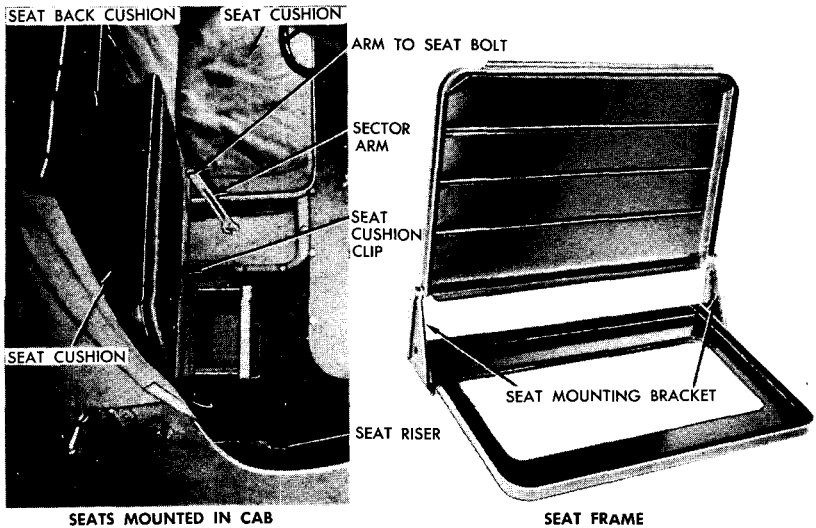

RA PD 332973

Figure 228—Seats Installed and Seat Frame Removed

bead in back cushion from metal channel in seat back. Tilt seat bottom up against seat back, then turn seat spring latch to side by tapping with hammer. Procedure is same for either seat.

(2) **DISCONNECT SECTOR ARM (RIGHT-HAND SEAT ONLY).** Tilt seat bottom up, then remove bolt, nut, and washers attaching sector arm to seat bottom.

(3) **REMOVE SEAT FRAME.** With seat bottom raised, remove three nuts and washers attaching mounting bracket on each side of seat to seat risers. Lift seat frame assembly from cab. Procedure is same for either seat.

c. Seat Installation.

(1) **INSTALL SEAT FRAME.** **NOTE:** *Seat having sector arm mounting lug on underside of seat bottom is the right-hand seat.* Position seat frame on seat riser with mounting bracket studs through holes in seat riser. Install three washers and nuts on mounting studs at each end of seat, and tighten nuts firmly. Procedure is same for either seat.

(2) **CONNECT SECTOR ARM (RIGHT-HAND SEAT ONLY).** Tilt seat bottom up, then attach sector arm to lug on seat bottom with bolt, nut, and washers.

(3) **INSTALL SEAT CUSHIONS.** Position seat cushion on seat bottom frame, then raise seat bottom. Engage seat spring clips with seat bottom frame by tapping into position with hammer. Tilt seat back forward and engage end of bead on seat back cushion with end of metal channel on top of seat back. Slide cushion into place to completely engage bead.

Section XL

SHEET METAL

225. ENGINE HOOD.

a. Engine hood consists of a formed and reinforced metal panel over top of engine. Hood is attached to cowl with two hinges and fastened in closed position at front end by two spring type catches.

b. Hood Removal.

(1) **RELEASE CATCHES AND DISCONNECT HOOD SUPPORT.** Lift up spring type catch at each front corner of hood and disengage from hood clip. Raise engine hood and remove the two bolts, nuts, and washers attaching support bracket to hood.

(2) **DISCONNECT RADIO SUPPRESSION BOND STRAPS.** Remove bolt and washers attaching two bond straps to underside of hood.

(3) **REMOVE HINGE BOLTS AND HOOD.** Close hood, unscrew two hinge bolts from hinges, then lift off hood.

c. Hood Installation.

(1) **POSITION HOOD AND INSTALL HINGE BOLTS.** Position hood over engine, aline hinges, and install two hinge bolts.

(2) **CONNECT HOOD SUPPORT.** Raise engine hood, position hood support bracket to underside of hood, then install two bolts, washers, and nuts, tightening nuts firmly.

(3) **CONNECT RADIO SUPPRESSION BOND STRAPS.** Connect two bond straps to underside of hood, using bolt and two internal-external toothed lock washers on each strap. Use one washer under head of bolt and the other between strap and hood. Close hood and pull up on spring type catch at each front corner of hood, engaging catch in clip attached to hood.

226. HOOD SIDE PANELS.

a. Hood side panel assembly consists of a front and rear panel at each side of engine above fender, bolted together through a reinforcing channel spot welded to front panel.

b. Hood Side Panel Removal (fig. 229).

(1) **REMOVE HOOD REAR SIDE PANEL.** Remove three bolts attaching rear side panel to front side panel. Remove bolt, nut, and washers attaching radio suppression bond strap to upper rear corner of panel. Pry open clip at upper rear corner of panel. Lift panel straight up to remove from vehicle. Procedure is same for either side.

(2) **REMOVE HOOD FRONT SIDE PANEL.** Remove three bolts, nuts, and washers attaching panel to brush guard and remove bolt, nut, and washers attaching panel reinforcement to fender skirt. Remove bolt, nut, and washers attaching panel to radiator brace. Slide panel to rear, then lift straight up to remove from vehicle. Procedure is same for either side.

c. Hood Side Panel Installation (fig. 229).

(1) **INSTALL HOOD FRONT SIDE PANEL.** Position panel on vehicle with lower edge engaged in clip on fender skirt. Aline bolt

TRUCK, 2½-TON, 6 x 6

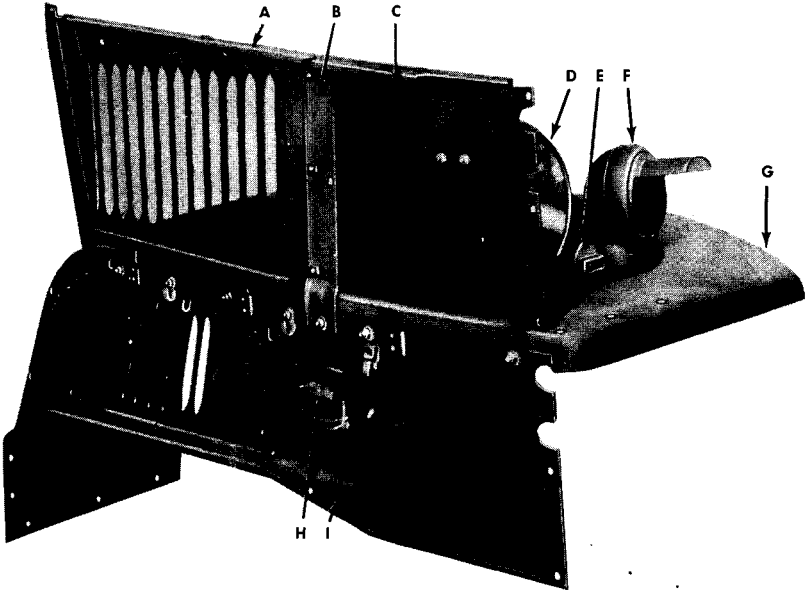

LEFT FRONT FENDER AND ENGINE CLOSURE PANELS

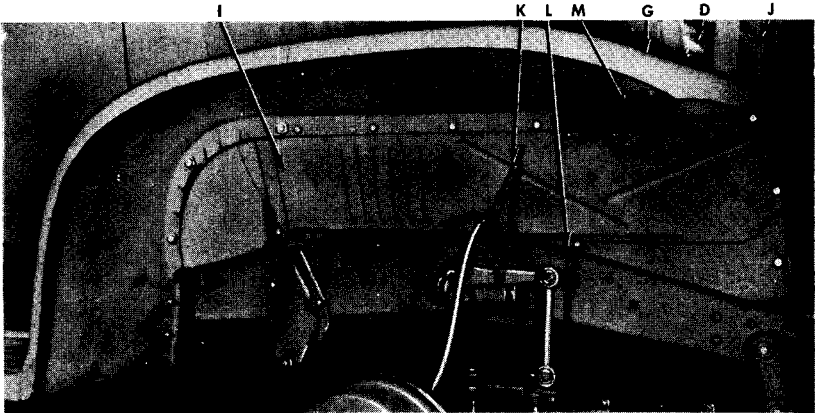

RIGHT FRONT FENDER AND SKIRT

- | | |
|--------------------------|-------------------------|
| A HOOD REAR SIDE PANEL | H WIRING JUNCTION BLOCK |
| B REINFORCEMENT CHANNEL | I FRONT FENDER SKIRT |
| C HOOD FRONT SIDE PANEL | J BRUSH GUARD |
| D HEAD LIGHT | K BRAKE HOSE SPRING |
| E BLACKOUT MARKER LIGHT | L BOND STRAP |
| F BLACKOUT DRIVING LIGHT | M FENDER REINFORCEMENT |
| G FRONT FENDER | |

RA PD 332897

Figure 229—Fender, Skirt, and Hood Panels

SHEET METAL

holes and install three bolts and nuts and six internal-external toothed lock washers attaching panel to brush guard. Use one washer under head of bolt and another under nut. Install one bolt and nut and two internal-external toothed lock washers attaching panel reinforcement to skirt, using one washer under bolt head and the other under the nut. Install one bolt and nut, and two internal-external toothed lock washers attaching panel to radiator brace, using one washer under bolt head and the other washer under the nut.

(2) **INSTALL HOOD REAR SIDE PANEL.** Position panel with lower edge engaged in fender skirt clips and aline bolt holes. Install three bolts and internal-external toothed lock washers attaching panel to front panel reinforcement, with washers under bolt heads. Connect radio suppression bond strap to upper rear corner of panel with one bolt and nut and three internal-external toothed lock washers. Use one washer under bolt head, one washer between strap and panel, and the other washer between strap and nut. Bend clip together with hammer. Procedure is same for either side.

227. FENDERS AND SKIRTS.

a. Front fender and skirt, consisting of fender and louvred metal panel at side of engine, are bolted together. Headlights and blackout lights are mounted on the front end of fenders. While either fender or skirt can be removed and replaced without removal of the other part, replacement is facilitated by removal of fender and skirt as an assembly.

b. **Fender and Skirt Removal** (fig. 229). Operations are same for either fender except as otherwise noted in text.

(1) **DISCONNECT WIRING.** Raise engine hood. Disconnect wiring harness at inside of fender skirt by loosening screws attaching harness to junction block and disconnecting blackout marker light wire at connector. Disengage wiring harness from all clips mounted on fender skirt.

(2) **UNHOOK BRAKE HOSE SPRING AND DISCONNECT BOND STRAP.** Unhook brake hose spring from fender skirt. Remove nut, washers, and bolt attaching radio suppression bond strap to lower edge of fender skirt.

(3) **REMOVE CAP SCREWS AND BOLTS.** Remove two cap screws and washers attaching fender to cowl at underside of fender. Remove bolt, nut, and washers attaching fender to cowl bracket, then remove anti-squeak from between fender and cowl. Remove bolt and washer attaching lower rear corner of fender skirt to cowl.

(4) **REMOVE FENDER TO RUNNING BOARD BOLTS.** Remove five bolts, nuts, and washers attaching fender to running board, then remove anti-squeak from between running board and fender.

(5) **REMOVE FENDER TO BRUSH GUARD BOLTS.** Remove three bolts, nuts, and washers attaching fender to brush guard.

(6) **DISCONNECT WIRING AND DISASSEMBLE** (fig. 230). Remove fender and skirt assembly from vehicle. Disconnect light wires from junction block at inner side of fender skirt. Loosen wire grommets

TRUCK, 2 1/2-TON, 6 x 6

at holes in fender skirt and pull wires through skirt. Remove the six bolts, washers, and nuts attaching fender skirt to fenders. If lights are to be removed, refer to paragraphs 121, 122, and 123.

c. **Fender and Skirt Installation** (figs. 229 and 230). Installation operations are same for either fender except as noted in text. Install lights as directed in paragraphs 121, 122, and 123.

(1) **ASSEMBLE FENDER AND SKIRT.** Assemble fender skirt to fender with six bolts and nuts and 12 internal-external toothed lock washers, omitting bolt in third hole from front. On left front fender only, install a wiring harness clip on fourth and sixth bolt from front, using an additional internal-external toothed lock washer between clip and skirt. Thread light wiring through holes in skirt and fit grommets in place.

(2) **POSITION FENDER AND SKIRT AND INSTALL BOLTS.** Position fender and skirt assembly on vehicle, with lower edge of hood side panels engaged in fender skirt clips. Install anti-squeak between fender and cowl, then install two cap screws and washers attaching fender to cowl. Install bolt with washer and nut through fender and cowl bracket. Install cap screw with internal-external toothed lock washer under head attaching lower rear corner of fender skirt to cowl.

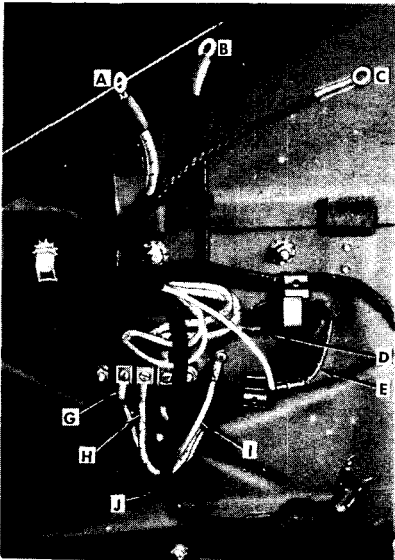

LEFT SIDE CONNECTIONS

- A GENERATOR ARMATURE
- B GENERATOR GROUND
- C GENERATOR FIELD
- D BLACKOUT DRIVE LIGHT
- E BLACKOUT MARKER

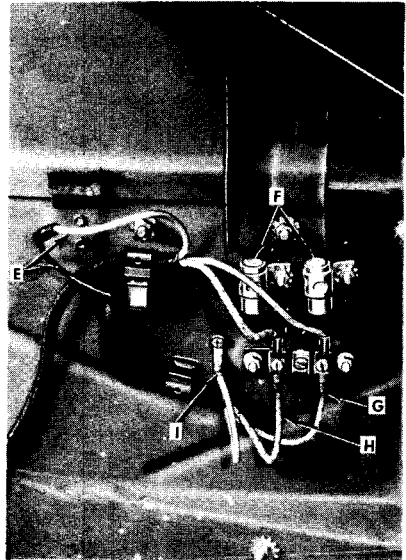

RIGHT SIDE CONNECTIONS

- F CONDENSER
- G HEADLIGHT LOW BEAM
- H HEADLIGHT HIGH BEAM
- I HEADLIGHT GROUND
- J HORN

RA PD 332932

Figure 230—Fender Skirt Wiring Junction Blocks

SHEET METAL

(3) **BOLT FENDER TO BRUSH GUARD.** Install three bolts and nuts and six internal-external toothed lock washers attaching fender to brush guard. Use washers under bolt heads and under nuts.

(4) **ATTACH FENDER TO RUNNING BOARD.** Position anti-squeak between fender and running board and install 5 bolts, nuts and lock washers, and 10 flat washers attaching fender to running board.

(5) **CONNECT BRAKE HOSE SPRING AND BOND STRAP.** Hook brake hose spring in fender skirt. Connect radio suppression bond strap to lower edge of fender skirt with bolt, nut, and three internal-external toothed lock washers. Position washers under bolt head, under nut, and between bond strap and skirt.

(6) **CONNECT WIRING** (fig. 230). Connect wiring harness at junction block at inner side of fender skirt. Refer to figure 113 or 114 for wire identification and proper connections. Connect blackout marker light wire at connector. Attach wiring harness to fender skirt clips and close engine hood.

228. RUNNING BOARDS AND STEP HANGERS.

a. Running Board and Hanger Removal.

(1) **REMOVE RUNNING BOARD.** Remove five bolts, nuts, and washers attaching fender to running board, and remove fender to running board anti-squeak. Remove four running board to step hanger bolts, nuts, and washers. Lift running board off step hangers and remove wood spacer from front step hanger. Procedure is same for either side.

(2) **REMOVE REAR STEP HANGER** (fig. 231). Remove nut and washers attaching suppression bond strap to upper step hanger bolt and remove strap. Remove three bolts, nuts, and washers attaching hanger to frame and remove hanger. Procedure is same for either rear hanger.

(3) **REMOVE RIGHT FRONT STEP HANGER.** Remove three bolts, nuts, and washers, then remove hanger and frame spacer.

(4) **REMOVE LEFT FRONT STEP HANGER** (fig. 231). Hanger mounting cap screws are threaded into a tapping plate not otherwise attached to frame side rail. Following procedure must be observed to prevent dislodging plate.

(a) Remove both lower cap screws and washers, then loosen upper cap screw sufficiently to swing hanger to the rear.

(b) Install cap screw in one of the lower holes and tighten firmly.

(c) Remove upper cap screw, hanger, and frame spacer. Cap screw in lower hole holds tapping plate in place.

b. Running Board and Hanger Installation.

(1) **INSTALL LEFT FRONT STEP HANGER** (fig. 231). Position spacer and hanger to side rail and install upper bolt and washer finger-tight (fig. 231). Remove lower bolt holding tapping plate and swing spacer and hanger into position. Install two lower bolts and washers, making sure hole in spacer is alined with front lower hole in hanger. Tighten all bolts firmly.

(2) **INSTALL RIGHT FRONT STEP HANGER.** Position hanger and

TRUCK, 2 1/2-TON, 6 x 6

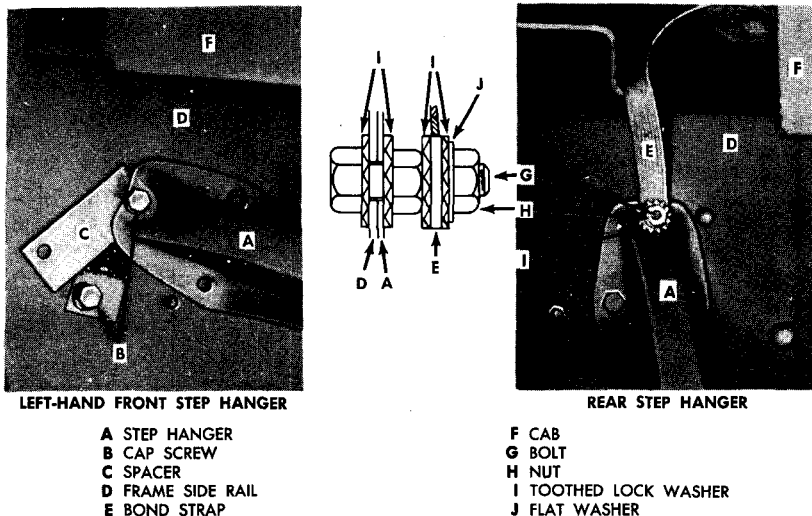

RA PD 333004

Figure 231—Step Hanger Installation

spacer on frame side rail with holes in spacer alined with upper and front lower holes in hanger. Install three bolts, nuts, and washers, tightening nuts firmly.

(3) **INSTALL REAR STEP HANGER** (fig. 231). Install an internal-external toothed lock washer on a long bolt, position hanger to frame, then install bolt from inside frame through upper hole of hanger. Install internal-external toothed lock washer and nut. Install two short bolts, nuts, and washers in lower holes in right rear hanger. (In left rear hanger, install a short bolt in rear lower hole and a long bolt in front lower hole.) Install internal-external toothed lock washer on upper bolt, then install bond strap, internal-external toothed washer, flat washer, and nut.

(4) **INSTALL RUNNING BOARD**. Position wood spacer on front step hanger, then position running board on hangers. Install two bolts, nuts, and washers to attach running board to each hanger, using longer bolts through front hangers. Position anti-squeak between running board and fender, and install five bolts, nuts, and lock washers, and 10 flat washers to attach rear end of fender to running board.

Section XLI

CARGO AND DUMP BODIES

229. GENERAL.

a. Cargo body and cargo dump body, while of similar size and appearance, differ in construction. Cargo body is of metal-reinforced

CARGO AND DUMP BODIES

wooden construction, whereas dump body is of all-steel construction.

b. Body mountings, in general, include hold down bolts and clips attaching body longitudinal sills to chassis frame side rails, a locating bolt through rear end of each body longitudinal sill and frame side rail, and flexible mountings at front end of body (144-inch cargo body only).

230. CARGO BODY.

a. **General.** Two lengths of cargo bodies are used—the 108-inch body on the 145-inch wheelbase model (CCKW-352), and the 144-inch body on the 164-inch wheelbase model (CCKW-353). The 108-inch and the 144-inch bodies are similar, and comprise wooden strips, slats, and panels bolted together and reinforced by steel strips, angles, and brackets. Cargo bodies are equipped with end curtains and tarpaulin, removable tarpaulin bows, and cargo racks.

b. **Wood Cargo Body Mountings.** The 108-inch body (CCKW-352—145-inch wheelbase) uses two locating bolts and six mountings of any of the three types shown in figure 232. The 144-inch body

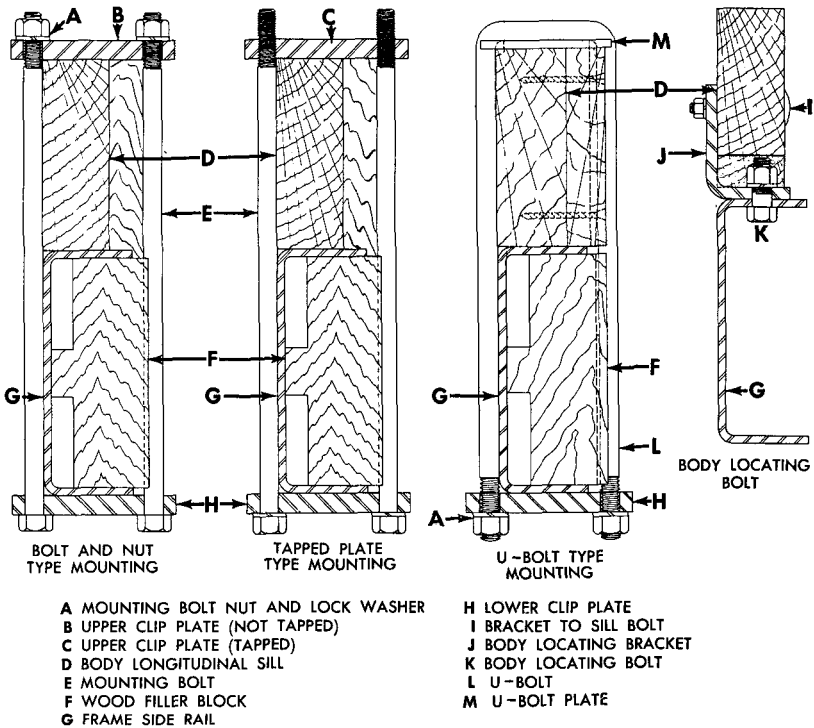

Figure 232—Sectional Views of Wood Cargo Body Mountings

RA PD 332763

TRUCK, 2½-TON, 6 x 6

(CCKW-353—164-inch wheelbase) uses two locating bolts, four mountings of any of the types shown in figure 232, and two flexible mountings (fig. 233).

(1) **BOLT AND NUT TYPE MOUNTING REMOVAL** (fig. 232). Remove two nuts, lock washers, and clip plate from upper end of two mounting bolts. Remove lower clip plate and bolts, then remove wood filler block from frame side rail.

(2) **BOLT AND NUT TYPE MOUNTING INSTALLATION** (fig. 232). Fit wood filler block in frame side rail. Assemble two clips and one lock washer on one bolt, and start nut on threads. Position assembly of bolt and clips on sill and frame, with bolt in groove in filler block and nut at top. Install second mounting bolt through clips, then install lock washer and nut. Tighten nuts firmly and with equal tension.

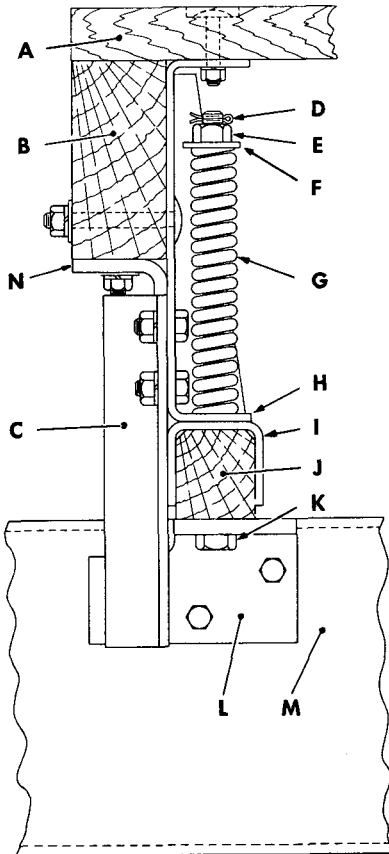

- A BODY FLOOR
- B BODY FRONT CROSS SILL
- C BODY GUIDE ANGLE
- D MOUNTING BOLT COTTER PIN
- E MOUNTING BOLT NUT
- F MOUNTING BOLT WASHER
- G MOUNTING BOLT TENSION SPRING
- H MOUNTING SUPPORT PLATE
- I SPACER BLOCK REINFORCEMENT
- J WOOD SPACER BLOCK
- K MOUNTING BOLT
- L FRAME SIDE RAIL BRACKET
- M FRAME LEFT SIDE RAIL
- N SILL BRACKET

Figure 233—Sectional View of Body Front Corner Flexible Mounting (CCKW-353 Only)

RA PD 316828

CARGO AND DUMP BODIES

(3) **TAPPED PLATE TYPE MOUNTING REMOVAL** (fig. 232). Unscrew two bolts from tapped upper clip plate, remove bolts, lock washers, and lower clip plate, then remove tapped plate. Remove wood filler block from frame side rail.

(4) **TAPPED PLATE TYPE MOUNTING INSTALLATION** (fig. 232). Position wood filler block in frame side rail. Install two mounting bolts with lock washers through holes in lower clip plate, and position around frame side rail and body sill. Place tapped plate on body sill, threading bolts into tapped holes in plate. Tighten bolts firmly and with equal tension.

(5) **U-BOLT TYPE MOUNTING REMOVAL** (fig. 232). Remove two nuts and lock washers, and lower clip plate from U-bolt. Remove U-bolt and U-bolt plate from body sill, then remove wood filler block from frame side rail.

(6) **U-BOLT TYPE MOUNTING INSTALLATION** (fig. 232). Position wood filler block in frame side rail, then position U-bolt and U-bolt plate over body longitudinal sill with inner leg of U-bolt in groove in filler block. Position clip plate on U-bolt, then install two nuts and lock washers, tightening nuts firmly and with equal tension.

(7) **BODY LOCATING BOLT REMOVAL** (fig. 232). At rear end of body longitudinal sill, unscrew bolt from underside of frame while holding nut with wrench. Remove bolt, nut, and lock washer, but do not remove bolts attaching locating bracket to body sill.

(8) **BODY LOCATING BOLT INSTALLATION** (fig. 232). Aline hole in body locating bracket with hole in upper flange of frame side rail, using drift. Install bolt from underside of side rail flange, install lock washer and nut, then tighten bolt into nut while holding nut with wrench.

(9) **FLEXIBLE FRONT MOUNTING BOLT REMOVAL** (fig. 233). Remove cotter pin, nut, and flat washer from upper end of mounting bolt above tension spring. Remove mounting bolt and tension spring.

(10) **FLEXIBLE FRONT MOUNTING BOLT INSTALLATION** (fig. 233). Install long mounting bolt through frame bracket, wood spacer block, reinforcement, and support plate. Position tension spring over end of mounting bolt, and install flat washer and nut. Tighten nut sufficiently to compress spring slightly and secure nut with cotter pin.

c. Cargo Body Tailgate.

(1) **TAILGATE REMOVAL** (fig. 234). Unhook tailgate chains and

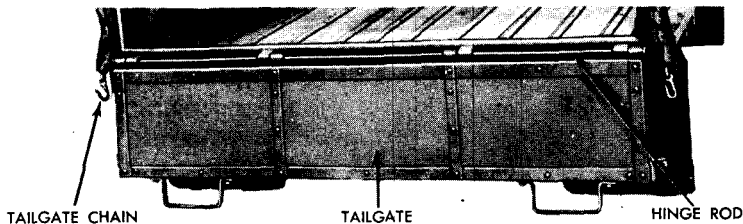

Figure 234—Cargo Body Tailgate

RA PD 332903

TRUCK, 2½-TON, 6 x 6

swing tailgate down. Remove cotter pin and flat washer from one end of hinge rod. Withdraw hinge rod from hinges while supporting tailgate.

(2) TAILGATE INSTALLATION (fig. 234). Position tailgate on body and align hinges. Insert hinge rod through hinges, then install flat washer and cotter pin on end of hinge rod.

231. CARGO DUMP BODY.

a. General. All steel dump body is hinged at rear to hoist subframe which is mounted on frame side rails. Subframe is attached to chassis with four U-bolts and two locating bolts of type shown in figure 235. Cargo dump bodies are equipped with end curtains, tarpaulin, removable tarpaulin bows, and side cargo racks.

b. Cargo Dump Body Mountings.

(1) SUBFRAME TO FRAME SIDE RAIL MOUNTING REMOVAL (fig. 235). Remove two nuts, lock washers, and clip plate from lower end of mounting U-bolt. Remove U-bolt from around subframe channel and frame side rail. Remove wood filler block from frame side rail.

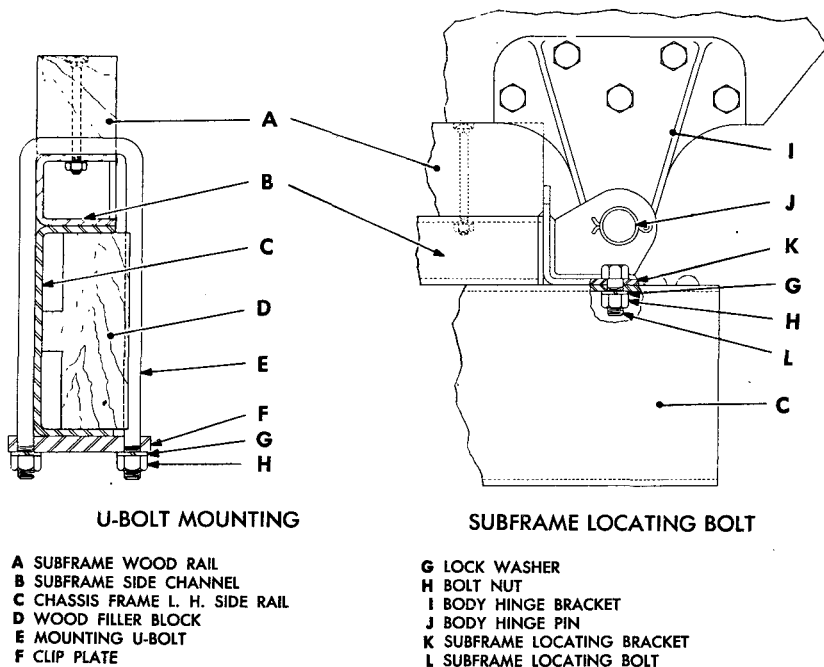

- A SUBFRAME WOOD RAIL
- B SUBFRAME SIDE CHANNEL
- C CHASSIS FRAME L. H. SIDE RAIL
- D WOOD FILLER BLOCK
- E MOUNTING U-BOLT
- F CLIP PLATE

- G LOCK WASHER
- H BOLT NUT
- I BODY HINGE BRACKET
- J BODY HINGE PIN
- K SUBFRAME LOCATING BRACKET
- L SUBFRAME LOCATING BOLT

Figure 235—Sectional Views of Cargo Dump Body Mountings

RA PD 64740

CARGO AND DUMP BODIES

(2) SUBFRAME TO FRAME SIDE RAIL MOUNTING INSTALLATION (fig. 235). Position wood filler block in frame side rail. Position U-bolt on subframe channel with inner leg of U-bolt in groove in wood filler block. Install clip plate, lock washers, and nuts on U-bolt, tightening nuts firmly and with equal tension.

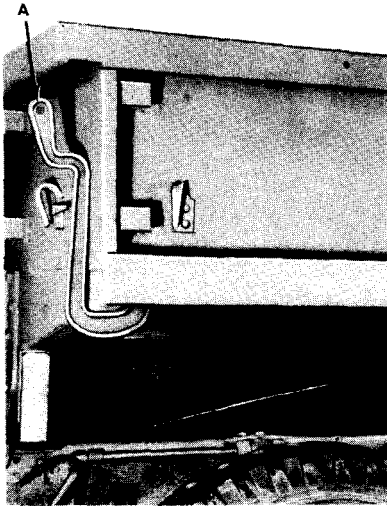

TAILGATE RELEASE LEVER

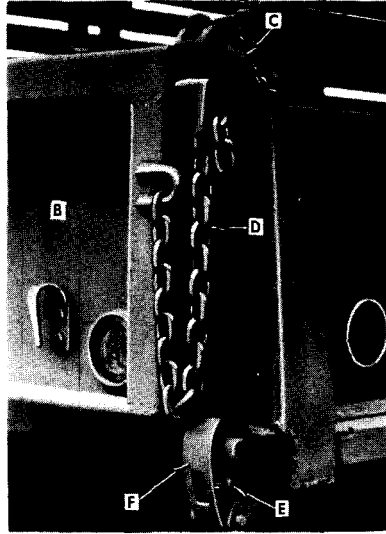

TAILGATE, PINS, AND CHAINS

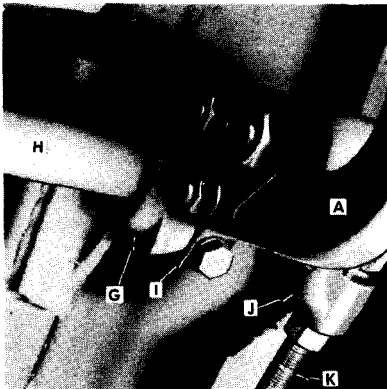

RELEASE LEVER AND LINKAGE—LEFT SIDE

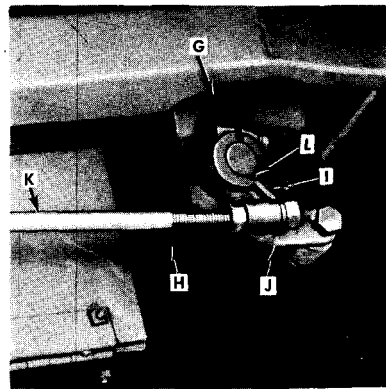

RELEASE CROSS SHAFT AND LINKAGE—RIGHT SIDE

- A RELEASE LEVER
- B TAILGATE
- C UPPER HINGE PIN
- D DROP CHAIN
- E RELEASE ROD CLEVIS PIN
- F LOCKING CLAMP

- G SUPPORT BRACKET
- H CROSS SHAFT
- I ARM
- J CLEVIS
- K ROD
- L KEY

Figure 236—Cargo Dump Body Tailgate and Release Linkage

RA PD 332963

TRUCK, 2 1/2-TON, 6 x 6

(3) **SUBFRAME LOCATING BOLT REMOVAL** (fig. 235). Aline hole in subframe locating bracket with hole in upper flange of frame side rail, using drift. Install bolt through locating bracket and frame side rail, install lock washer and nut, then tighten nut firmly.

(4) **SUBFRAME LOCATING BOLT INSTALLATION** (fig. 235). Aline hole in subframe locating bracket with hole in upper flange of frame side rail, using drift. Install bolt through locating bracket and frame side rail, install lock washer and nut, then tighten nut firmly.

e. Cargo Dump Body Tailgate.

(1) **TAILGATE REMOVAL** (fig. 236). At left front of body pull tailgate release lever downward to release tailgate lower hinge pins. Detach drop chains from body. Remove pins from upper brackets, then lift off tailgate.

(2) **TAILGATE INSTALLATION** (fig. 236). Position tailgate on body with upper hinge pins in brackets and insert bracket pins in brackets. At left front of body, move tailgate release lever up against body to lock bottom of tailgate to body.

d. Tailgate Release Linkage.

(1) **RELEASE LINKAGE REMOVAL** (fig. 236). Remove the three bolts, nuts, and washers attaching release lever to arm and clevis, then remove lever. Remove bolt, nut, and washer attaching clevis to right side cross shaft arm. Remove screws and washers clamping arms to cross shaft, then remove arms and keys from cross shaft, and remove cross shaft from support brackets. Remove clevis and two nuts and washers from front end of side control rod. At rear end of body, remove cotter pin attaching control rod to locking clamp, then swing clamp down. Pull rod out of guides and lower hinge bracket. Removal procedure is same for either rod.

(2) **RELEASE LINKAGE INSTALLATION** (fig. 236). Position cross shaft in support brackets, install arms and Woodruff keys on shaft, then tighten clamp screws firmly. Position side control rods in guides, then attach rear end of rods to locking clamps and secure with cotter pins. Install nut, washer, clevis, washer, and nut loosely on each control rod, then attach right-hand clevis to arm with bolt, washer and nut. Attach release lever to left-hand arm with two bolts, nuts, and washers, then attach clevis to lever and arm with a bolt, nut, and washer. Adjust control rod length by means of the two nuts on each rod, then tighten nuts firmly.

232. TROOP SEATS AND CARGO RACKS.

a. Description. Cargo racks and troop seats are supplied with wood cargo bodies and dump cargo bodies. Cargo racks consist of right and left side racks incorporating full length troop seats and a front rack. Side racks for cargo and dump bodies are similar, but front rack for dump bodies includes a hinged cab protector. Rack stakes fit into pockets at sides and front of body to support racks. A latch at each end of seat section holds seat in folded position as part of rack. When lock plates are released, seats fold down and are supported on hinged legs.

CARGO AND DUMP BODIES

b. Cargo Rack Removal.

(1) REMOVE TROOP SEATS ONLY. Remove cotter pins and hinge pins from all five hinges attaching each seat to rack stakes. Release lock plates, disengage hinges, and lift troop seat out of body.

(2) REMOVE FRONT CARGO RACK (CARGO BODY ONLY). Tarpaulins and bows must be removed before attempting to remove any of the cargo racks. Lift straight up on front rack while standing inside body. When rack stakes are clear of front stake pockets, remove rack from body.

(3) REMOVE SIDE CARGO RACKS. Lift each rack straight up to free ends of stakes from pockets at sides of body. Remove racks from vehicle.

(4) REMOVE FRONT RACK (CARGO DUMP BODY ONLY). Side cargo racks must first be removed. Remove the four bolts, nuts, and washers attaching each front rack brace to body and rack and remove braces. Lift rack straight up to remove from body.

c. Cargo Rack Installation.

(1) INSTALL FRONT RACK (CARGO DUMP BODY ONLY). Lift rack onto body and position stakes in front pockets. Push down on rack to fully engage stakes in stake pockets.

(2) INSTALL SIDE CARGO RACKS ONLY. Position each rack on body with longitudinal slots on inner side of stakes. Engage stakes in pockets and push down on rack until hinge brackets fit down against body side. On dump body, make sure that eye on each side rack engages hook in front rack.

(3) INSTALL FRONT CARGO RACK (CARGO BODY ONLY). Position front rack on body and fit rack stakes into front stake pockets. Push down on rack, at the same time engaging lock pin at each end of rack in eye in side rack.

(4) INSTALL TROOP SEATS ONLY. Position troop seats on side rack hinge brackets and aline hinge holes with drifts. Install hinge pin and cotter pin in each of five hinges for each troop seat. Fold seat up against side rack and fasten in place with seat latch at each end.

Section XLII

GASOLINE AND WATER TANK BODIES

233. GASOLINE TANK BODY.

a. General. Gasoline tank body consists of two elliptical shaped tanks of 375-gallon capacity each, mounted on a welded steel cradle. Gravity discharge through emergency valves into pipes manifolding into a rear discharge faucet is controlled by levers in the right rear compartment. Valves can be opened or closed by means of these

TRUCK, 2 1/2-TON, 6 x 6

levers; valves can also be closed by a trip release at left front corner of body.

b. Mountings. Gasoline tank body is attached to chassis frame side rails with eight side mountings and two locating bolts as shown in figure 237.

c. Mounting Removal.

(1) REMOVE BODY TO FRAME SIDE RAIL MOUNTING (fig. 237). Remove two nuts, lock washers, and tee plate from lower end of mounting U-bolt. Remove U-bolt from around body sill and sill channel, then remove wood filler block from frame side rail.

(2) REMOVE LOCATING BOLT (fig. 237). At rear of vehicle remove nut, lock washer, and bolt attaching body sill and sill channel to chassis frame side rail.

d. Mounting Installation.

(1) INSTALL LOCATING BOLT (fig. 237). Aline holes in body sill, channel, and frame side rail with drift, then install bolt through sill channel, sill, and upper flange of frame side rail. Install lock washer and nut, and tighten firmly.

(2) INSTALL BODY TO FRAME SIDE RAIL MOUNTING (fig. 237). Fit wood filler block in frame side rail, then position U-bolt around body sill and frame side rail with inner leg of U-bolt in groove in filler block. Install tee plate, two lock washers, and nuts on U-bolt, tightening nuts firmly.

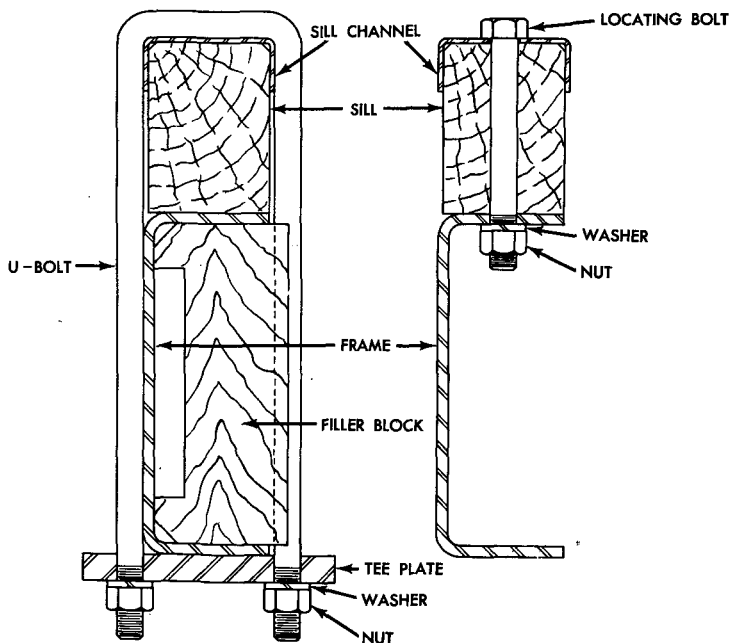

Figure 237—Sectional Views of Gasoline Tank Body Mountings

RA PD 332813

GASOLINE AND WATER TANK BODIES

e. Controls and Linkage.

(1) **REMOVE SELECTIVE VALVE OPERATOR** (fig. 238). Disconnect trip cable from front end release lever clevis by unscrewing compression nut. Remove two cable connector nuts, then remove connectors to disconnect both valve cables. Remove the six nuts and washers, and the four bolts attaching operator assembly to cabinet, then remove operator from cabinet.

(2) **INSTALL SELECTIVE VALVE OPERATOR** (fig. 238). Position operator assembly in cabinet, threading cables and pipes through bearing bracket spacer. Attach operator to cabinet with four bolts, and six nuts and washers. Attach two valve cables to levers with cable connectors and nuts, making sure cables have a slight amount of slack with valves fully closed, and with valve levers in closed position. Tighten cable connector nuts firmly. Attach trip cable to release lever clevis with compression nut and sleeve, making sure cable is of correct length to insure proper trip release.

(3) **REMOVE CABLE** (fig. 238). Cables can be removed and replaced without removal of either selective valve operator or emergency valves. Disconnect cable at valve operator and at either valve or front end trip release as the case may be, by removing compression nuts or cable connectors. Withdraw cable from pipe.

(4) **INSTALL CABLE**. Squeeze or solder end of cable to prevent spreading, then apply a light coating of general purpose grease No.

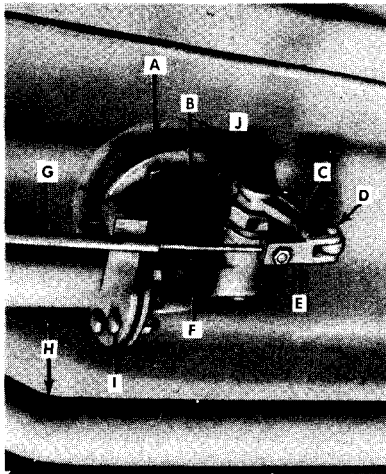

EMERGENCY VALVE

- A SUMP
- B VALVE
- C VALVE ARM
- D CLEVIS PIN
- E CLEVIS
- F OPERATOR CABLE
- G CABLE PIPE

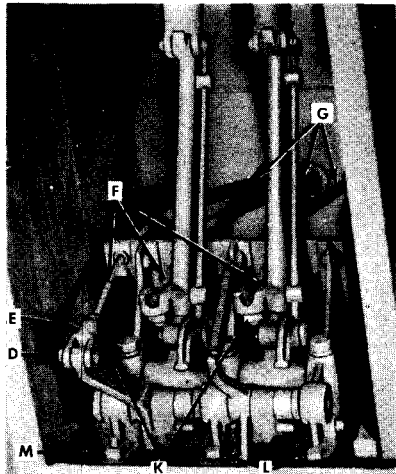

EMERGENCY VALVE OPERATOR

- H DISCHARGE PIPE
- I BOLT
- J CAP SCREW
- K CABLE NUT
- L MOUNTING BOLT
- M MOUNTING NUT

Figure 238—Emergency Valve and Controls

RA PD 332956

TRUCK, 2 1/2-TON, 6 x 6

0 to the cable. Feed cable into the pipe from the rear compartment, until cable emerges from other end of cable pipe. Connect cable to emergency valve or to front end trip release with cable connector or compression nut. Cut cable to proper length at operator, then connect to lever with connector or compression nut. Valve cables must have slight slack with valves fully closed.

f. Valves. Three valves are used on the gasoline tank body—one emergency valve in the bottom of each tank and a single discharge faucet at the rear end. Faucet may be removed and replaced without necessity of dumping load providing emergency valves are closed and are in good condition. **CAUTION: *Open flame must not be brought into vicinity while valves are being replaced, or while valves are removed.*** Fumes in tank and lines may constitute a highly explosive mixture.

(1) **REMOVE DISCHARGE FAUCET.** Close both emergency valves, then open discharge faucet with faucet wrench to drain pipes. Hold rear pipe with pipe wrench; with another wrench applied to hexagon part of faucet, unscrew faucet.

(2) **INSTALL DISCHARGE FAUCET.** Coat pipe threads with aviation type cement. Hold rear discharge pipe with pipe wrench; with another wrench applied to hexagon part of faucet, screw faucet to pipe.

(3) **REMOVE EMERGENCY VALVE** (fig. 238). Empty tank from which valve is to be removed, then close both emergency valves. Disconnect operator cable from valve arm by removing cotter pin and clevis pin. Remove the six bolts, nuts, and washers attaching pipe flange to valve flange. Remove the six cap screws attaching valve to sump, then remove valve and screen as an assembly. Slide screen off valve; clean screen by immersing in dry-cleaning solvent and brushing. Removal procedure is same for either valve.

(4) **INSTALL EMERGENCY VALVE** (fig. 238). Clean sump flange, pipe flange, and both valve flanges to remove all traces of cement and other foreign matter. Coat all flanges with aviation type cement, install screen on valve, then position valve on sump. Attach valve to sump with six cap screws and washers, tightening screws firmly. Loosen nuts on pipe hangers to permit alinement of pipe flange to valve, then attach pipe flange to valve with six bolts, nuts, and washers. Tighten pipe hanger nuts. Attach operator cable clevis to valve arm with clevis pin and secure pin with cotter pin. Installation procedure is same for either valve.

g. Cabinets. A wood-lined, steel cabinet is mounted on each run board for stowage of hoses and other equipment. Right-side cabinet also houses controls for emergency valves.

(1) **REMOVE CABINET.** In right-side cabinet only, remove the selective valve operator as described in subparagraph e (1) above. For either cabinet, remove the four bolts, nuts, and washers attaching cabinet to run boards. If vehicle is equipped for camouflage, four bolts, nuts, and washers attaching rear board assembly to each cabinet must be removed. Lift cabinet off run board.

GASOLINE AND WATER TANK BODIES

(2) **INSTALL CABINET.** Position cabinet on run board. In right-side cabinet only, thread cables and pipes through holes in cabinet as cabinet is slid into position on run board. Aline holes with drifts, then attach cabinet to run board with four bolts, nuts, and washers. In right-side cabinet only, install selective valve operator as described in subparagraph e (2) above. If vehicle is equipped for camouflage, attach rear board assembly to cabinet with four bolts, nuts, and washers.

234. WATER TANK BODY.

a. **General.** Water tank body consists of an insulated tank of 750-gallon capacity supported by two steel longitudinal box sills welded to tank bottom. Tank is equipped with an equipment compartment at the rear, and a pumping unit cabinet at front left side. Pumping unit cabinet contains pumping unit, gate valve, and control for emergency valve which is located on tank bottom. Tank is used to transport potable (drinking) water, therefore, when making replacements described in following paragraphs, *use every precaution to avoid contaminating tank or contents.*

b. **Mountings.** Water tank body is attached to chassis frame side rails with eight mountings and two locating studs as shown in figure 239.

c. Mounting Removal.

(1) **REMOVE BODY TO FRAME SIDE RAIL MOUNTING** (fig. 239). Remove two nuts, lock washers, and clip plate from mounting. Install nut on lower end of stud, then install a second nut tight against first nut. Use wrench on upper nut to unscrew stud from tapped plate welded to longitudinal sill at top of wood spacer rail. Remove nuts from stud. Remove second mounting stud in same manner. Remove wood filler block from frame side rail.

(2) **REMOVE BODY LOCATING STUD** (fig. 239). At rear end of wood spacer rail, remove nut and lock washer from locating stud at under side of frame side rail upper flange. Install nut on end of stud and install second nut tight against first nut. First nut must not be tight against frame side rail. Use wrench on upper nut to unscrew stud from tapped plate welded to longitudinal sill at top of wood spacer rail. If broken stud is to be removed, all body mountings must be removed or loosened, rear end of body raised to expose fractured end of stud, and stud unscrewed with suitable tool.

d. Mounting Installation.

(1) **INSTALL BODY LOCATING STUD** (fig. 239). At rear end of wood spacer rail, aline hole in frame with holes in wood spacer rail and tapped plate, using a drift. Install locating stud and screw into tapped plate welded to longitudinal sill with wrench applied to lower nut. Remove nuts from stud, install lock washer and nut on stud, then tighten nut firmly.

(2) **INSTALL BODY TO FRAME SIDE RAIL MOUNTING** (fig. 239). Position wood filler block in frame side rail. Screw two mounting studs into tapped plate, with inner stud in groove in wood filler block.

TRUCK, 2½-TON, 6 x 6

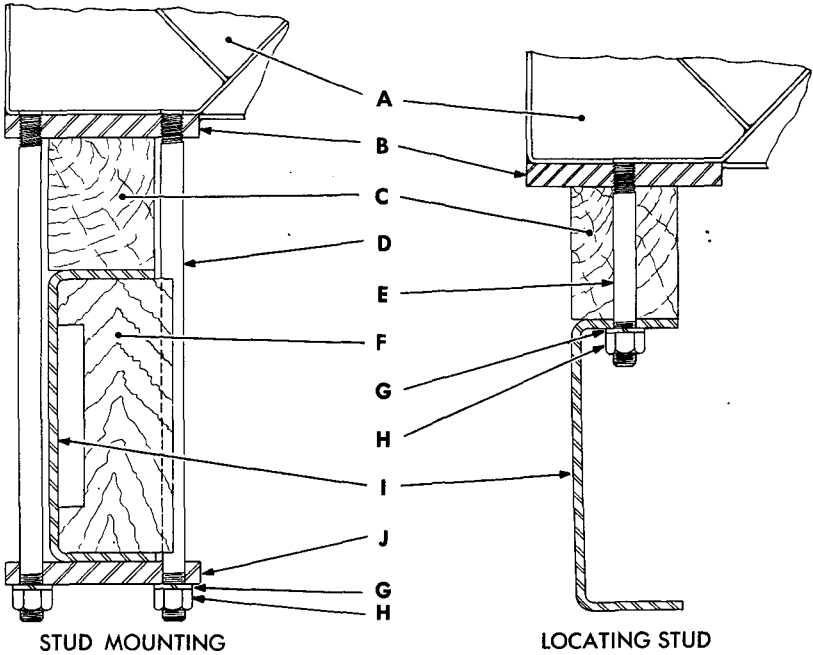

- | | |
|---------------------------------|------------------------|
| A WATER TANK BODY | F WOOD FILLER BLOCK |
| B MOUNTING STUD TAPPED PLATE | G LOCK WASHER |
| C WOOD LONGITUDINAL SPACER RAIL | H STUD NUT |
| D MOUNTING STUD | I FRAME LEFT SIDE RAIL |
| E LOCATING STUD | J LOWER CLIP PLATE |

RA PD 64763

Figure 239—Sectional Views of Water Tank Body Mountings

Use two nuts on stud, applying wrench to lower nut, then remove nuts. Install clip plate, lock washers, and nuts, tightening nuts firmly.

e. **Valves.** Two valves are used on water tank body; a gate valve in the pumping unit cabinet and an emergency valve in bottom of tank near front. Emergency valve is similar to that used on gasoline tank body (fig. 238) and is similarly attached to tank and pipe.

(1) **REMOVE GATE VALVE** (fig. 240). Make sure emergency valve is closed, then remove bolts from pump flange at suction port. Remove six pipe flange bolts, nuts, and washers, then remove assembly of valve and pipes from pumping unit cabinet. Remove hose connection nipple from valve by unscrewing with pipe wrench, then unscrew valve from pipe, using pipe wrenches.

(2) **INSTALL GATE VALVE** (fig. 240). Apply coating of aviation type cement to pipe threads, then screw valve on pipe and hose con-

GASOLINE AND WATER TANK BODIES

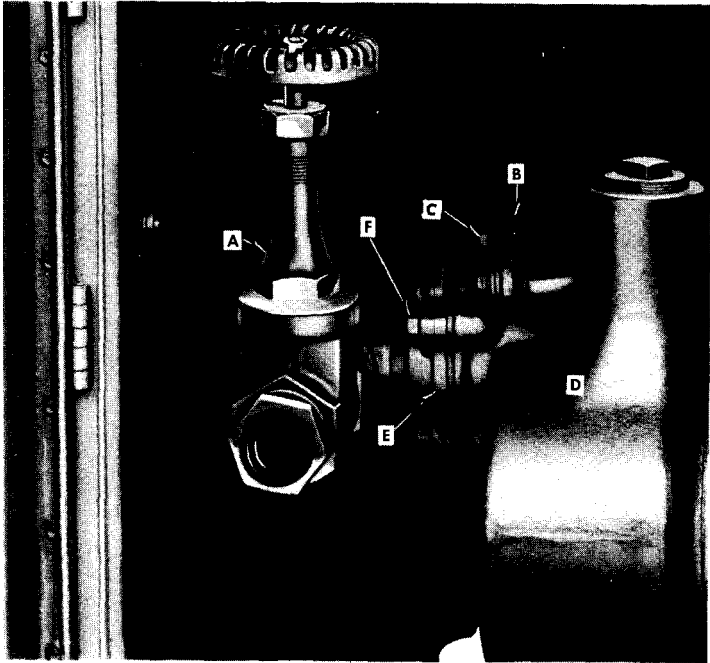

A VALVE
B PIPE FLANGE
C FLANGE BOLT

D PUMP
E SUCTION INLET
F CAP SCREW

RA PD 332976

Figure 240—Gate Valve Installed

nection nipple into valve, using pipe wrenches. Thoroughly clean pipe and pump flanges to remove all traces of cement, gasket, and foreign matter. Coat both sides of a new pipe flange gasket with aviation type cement, position gasket between flanges and attach flanges together with six bolts, nuts, and washers. Examine pump flange gasket and replace unless in good condition. Coat gasket with aviation type cement, then attach suction flange to pump with bolts and washers.

(3) **REMOVE EMERGENCY VALVE.** Tank must be drained before removal of valve. Remove the heating chamber bottom pan by removing 18 attaching bolts, nuts, and washers. Disconnect cable from valve arm. Remove six bolts, nuts, and washers attaching pipe flange to valve flange. Remove six cap screws and lock washers attaching valve to sump flange and remove valve. Slide screen off valve, immerse screen in dry-cleaning solvent and brush thoroughly. Wash screen in water, preferably hot water.

(4) **INSTALL EMERGENCY VALVE.** Thoroughly clean pipe and valve flanges to remove all traces of cement, bits of gasket, and foreign matter. Install screen on pump. Coat both sides of a new

GASOLINE AND WATER TANK BODIES

washers. Coat pump flange gasket with aviation type cement, position between suction flange and pump, then attach flange with bolts and washers.

g. **Strainers.** Three strainers are used on each water tank body—emergency valve strainer, filler hatch strainer, and vent strainer. Removal, cleaning, and installation of emergency valve strainer is described in subparagraph e (3) and (4) above. However, emergency valve strainer can also be replaced, without removal of emergency valve, by entering tank through manhole.

(1) **REMOVE FILLER HATCH STRAINER** (fig. 241). Using large pipe wrench, unscrew cap from four-inch diameter pipe projecting through walkway on top of tank. Lift assembly of cap and screen straight up to remove from body. Remove set screw from cap, then unscrew strainer screen from cap. Invert strainer and plunge rapidly up and down in a container of clean water. With strainer inverted, direct a stream of water against outside of strainer until all particles of foreign matter are dislodged and washed out. Blow strainer dry with compressed air, if available.

(2) **INSTALL FILLER HATCH STRAINER** (fig. 241). Screw strainer into cap, install set screw, and tighten firmly. Coat threads with aviation type cement, then screw filler hatch in place on pipe with large pipe wrench.

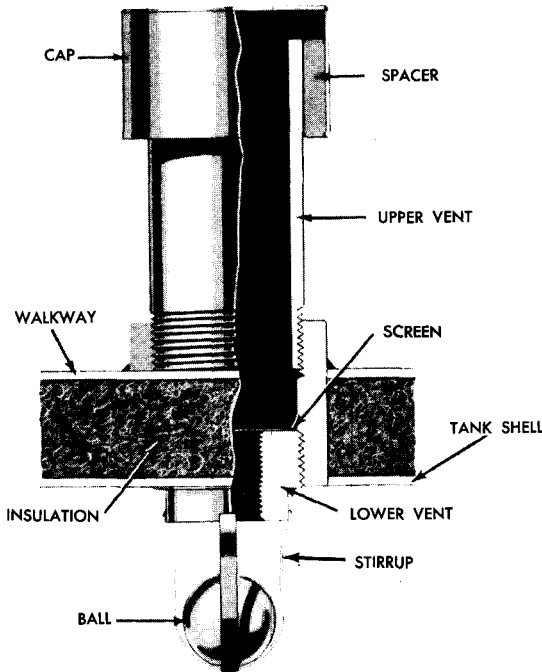

Figure 242—Water Tank Vent Assembly

RA PD 332805

TRUCK, 2½-TON, 6 x 6

(3) **REMOVE LOWER VENT** (fig. 242). Open manhole cover and remove manhole plug. From inside tank unscrew lower vent from pipe coupling welded to tank with adjustable wrench. Slush vent in clean water, or use stream of water to remove dirt from screen, then blow with compressed air, if available.

(4) **INSTALL LOWER VENT** (fig. 242). Screw lower vent into coupling inside tank with adjustable wrench. Install manhole plug and close manhole cover.

h. Cabinet Doors.

(1) **REMOVE PUMPING UNIT CABINET SIDE DOORS.** Remove staking at each of three hinge pins with a file, then drive out pins, using drift and hammer. Removal is same for either side door.

(2) **INSTALL PUMPING UNIT CABINET SIDE DOORS.** Position door to cabinet, position three hinge pins in hinges and tap into place with hammer. Stake pins in place with hammer or punch. Installation procedure is same for either side.

(3) **REMOVE PUMPING UNIT CABINET TOP DOOR.** Remove staking from both hinge pins with a file, then drive out pins using drift and hammer. Disengage catch and lift door straight up to remove from cabinet.

(4) **INSTALL PUMPING UNIT CABINET TOP DOOR.** Position door on cabinet and tap hinge pins into hinges with hammer. Stake hinge pins in place using hammer or punch.

(5) **REMOVE EQUIPMENT COMPARTMENT DOORS.** Remove staking from hinge rod with a file. With hammer and drift, drive rod out slightly. Pull projecting end of rod with pliers to withdraw rod, or tap pliers with hammer. Removal procedure is same for either door.

(6) **INSTALL EQUIPMENT COMPARTMENT DOORS.** Position door to body and mate hinge halves. Insert rod in hinge and tap gently into place with hammer. Stake end of hinge rod with hammer or punch. Installation procedure is same for either door.

Section XLIII

WINCH AND CONTROLS

235. DESCRIPTION.

a. **General** (fig. 243). The winch is a worm driven horizontal drum type, mounted at the front end of the vehicle on frame side rail extensions. Power for operating the winch is supplied by the vehicle engine through a power take-off and winch drive shaft. The winch controls consist of a winch power take-off control lever in the cab and a sliding clutch shift yoke at the winch. The winch is equipped with a drag brake which works in conjunction with the sliding clutch to prevent the drum from overrunning the cable when cable is pulled from drum. The winch automatic brake assembly acts on the winch worm shaft to hold the load when the power supply has been cut off.

WINCH AND CONTROLS

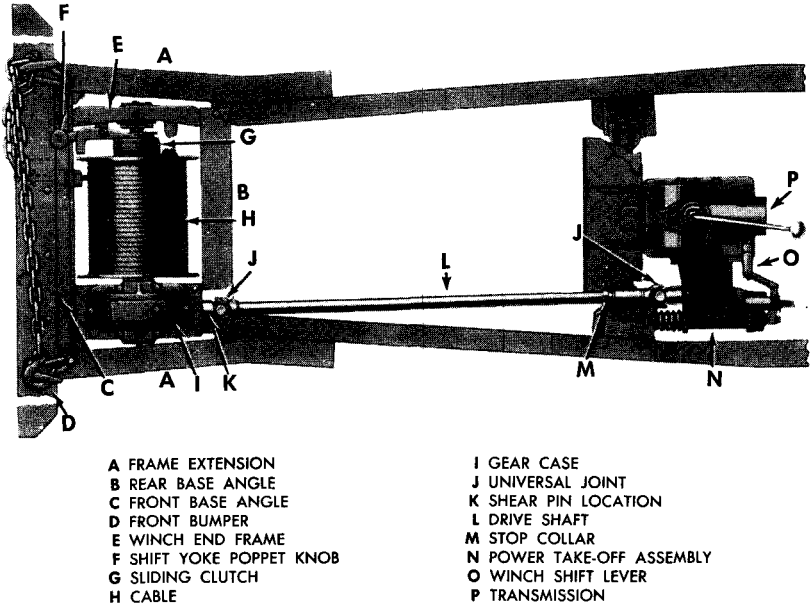

RA PD 316886

Figure 243—Winch System

b. Data.

| | | |
|------------------|-----------------------------|--------------|
| Type | Worm driven—horizontal drum | |
| Drive | From power take-off | |
| Capacity | 10,000 lb | |
| Make | Heil | Gar Wood |
| Vendor number | A157-E3 | GW 225-6225B |
| Model | 125G and 125G1 | 2 U512 |
| Winch cable dia. | ½ in. | |

236. ADJUSTMENT ON VEHICLE.

a. **General.** Adjustments can be made to compensate for normal wearing of brake lining, and should be made whenever tests show that adjustment is necessary. A modification of gear case cover used on some Gar Wood winch assemblies is also described in this paragraph, and should be applied to prevent entrance of water into gear case.

b. Adjustment Tests.

(1) **TEST DRAG BRAKE OPERATION.** Disengage sliding jaw clutch. Take hold of cable and begin to pull cable off drum. Drum should cease to revolve as soon as pull is stopped. If drum overruns cable, the drag brake requires adjustment.

(2) **TEST AUTOMATIC BRAKE OPERATION.** Place a winch equipped vehicle at top of a steep grade. Fasten winch cable to

TRUCK, 2 1/2-TON, 6 x 6

another vehicle at bottom of grade. Pull vehicle up grade, using winch only. When vehicle has been pulled part way up incline, depress engine clutch pedal, and shift power take-off into neutral. Vehicle being pulled should not roll backward; if it does, the need for automatic brake adjustment is indicated. **CAUTION:** *Brake may become warm even though it is properly adjusted; however, if hand cannot be held on brake cover on account of heat, this indicates that brake is too tight and should be loosened.* Brake is designed to hold load, and if properly adjusted, will not become overheated. Excessive heat indicates that brake band should be relined or the brake band assembly replaced.

c. Drag Brake Adjustment (fig. 244).

(1) **DISENGAGE SLIDING JAW CLUTCH.** Lift poppet knob and move shift yoke to disengage sliding clutch.

(2) **ADJUST DRAG BRAKE SPRING.** Insert screw driver or wedge between end of tension bolt and drag brake shoe. Force tension bolt away from shift yoke to permit use of wrenches on adjusting nut and lock nut. Loosen lock nut and back off adjusting nut one full turn, then remove wedge and check adjustment (subpar. b (1) above). Repeat above process, if necessary to obtain satisfactory brake operation. When correct adjustment is obtained, turn lock nut up tight against adjusting nut. In the event a satisfactory adjustment cannot be obtained, it will be necessary to reline brake or replace drag brake shoe assembly.

d. Automatic Brake Adjustment (fig. 244).

(1) **ADJUST BRAKE BAND SPRING TENSION.** Back off lock nut,

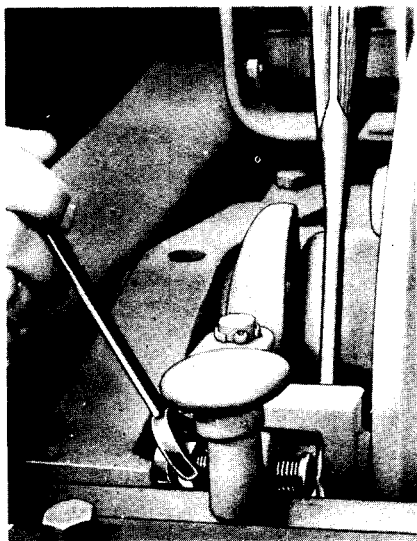

DRAG BRAKE ADJUSTMENT

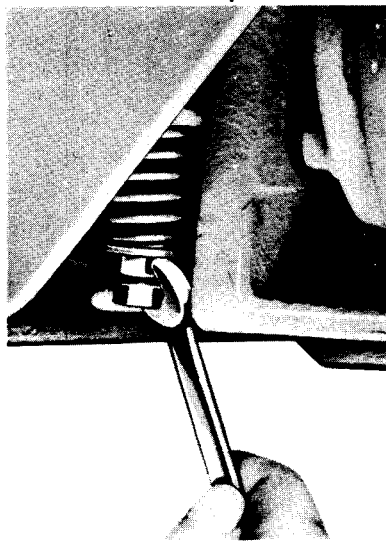

WINCH AUTOMATIC BRAKE ADJUSTMENT

Figure 244—Winch Adjustments on Vehicle

RA PD 332991

WINCH AND CONTROLS

then tighten adjusting nut one-half turn and reset lock nut against adjusting nut.

(2) **TEST ADJUSTMENT.** Accomplish procedure for automatic brake test (subpar. b (2) above). Repeat step (1) above if necessary to obtain correct adjustment. **NOTE:** *If brake will not hold load after adjustment or if it overheats when properly adjusted as indicated by test, it will be necessary to replace the brake band assembly (par. 237).*

e. **Gear Case Cover Modification** (Applicable to early Gar Wood winches only). On some vehicles equipped with Gar Wood winches a vent hole was drilled through gear case cover under the Gar Wood name plate. It has been established that in some instances water has entered the gear case through vent hole. If evidence of water is indicated when checking or draining lubricant from gear case of above mentioned winches, the following operations should be performed to prevent recurrence of this condition:

(1) **DRAIN GEAR CASE AND REMOVE COVER.** Remove drain plug and drain out contents of gear case. Remove six cap screws which attach worm gear case cover, then lift off cover.

(2) **CLEAN GEAR CASE AND PLUG VENT HOLE.** Wipe inside of gear case and gears to remove all traces of water. Coat a No. 6 (0.138 in.)-32NC-2x $\frac{3}{8}$ -inch self tapping screw, or a No. 6 (0.138 in.)-32NC-2x $\frac{1}{4}$ -inch sheet metal screw with shellac or permatex and drive screw, from inside of cover, into small vent hole in top of cover near the filler plug. Be certain that screw is tight in hole at finish of operation.

(3) **INSTALL COVER.** Install cover with gasket. Tighten cover screws evenly and firmly to assure correct fit over gear case bushings.

(4) **PREPARE WINCH FOR SERVICE.** Replace drain plug. Remove filler plug and oil level plug and fill gear case with gear oil (Section VIII) until the oil appears at level plug hole. Install filler plug after lubricant ceases to flow from level plug hole, and install level plug.

237. AUTOMATIC BRAKE BAND ASSEMBLY.

a. **General.** When for any reason it becomes necessary to replace the winch automatic brake band, the replacement may be accomplished without removing the winch assembly from the vehicle.

b. **Automatic Brake Band Removal.**

(1) **REMOVE FRONT BUMPER.** Remove front bumper (par. 215 b (3)).

(2) **SUPPORT WINCH ASSEMBLY.** Place a jack or other suitable support under winch assembly to hold weight of winch. This is necessary because front base angle must be disconnected from frame side rail extensions.

(3) **RAISE WINCH FRONT BASE ANGLE.** Remove six front base angle to side rail extension bolts. Remove two front base angle to gear case cap screws and two base angle to brake case cap screws (fig. 245); then, with pry bar, force left-hand end of front base

TRUCK, 2½-TON, 6 x 6

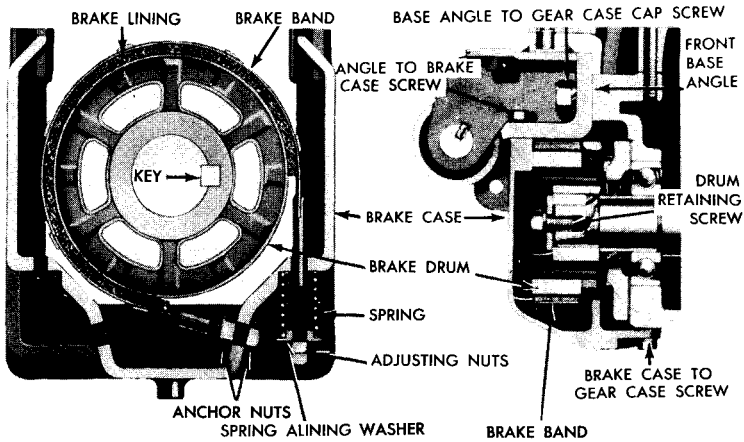

RA PD 333055

Figure 245—Sectional Views of Winch Automatic Brake Assembly

angle upward to provide clearance for brake case removal.

(4) **REMOVE BRAKE CASE** (fig. 245). Relieve spring tension on brake band by removing lock nut, adjusting nut, alining washer, and spring from brake band rod end. Remove two brake case to gear case cap screws then pull brake case and brake band assembly forward and remove from winch.

(5) **REMOVE BRAKE BAND FROM CASE.** Remove anchor nut from brake band rod end on outside of case. Lift band assembly from case and remove anchor nut which remains on threaded rod end (fig. 245).

c. Automatic Brake Band Installation (fig. 245).

(1) **MOUNT BRAKE BAND ASSEMBLY IN CASE.** With one anchor nut installed on end of brake band, position brake band assembly in case. Screw anchor nut on larger rod, at outside of case, until approximately two threads protrude through nut; then screw inside anchor nut down against case finger-tight.

(2) **INSTALL BRAKE CASE AND BAND ASSEMBLY ON WINCH.** Move brake case and band assembly over the brake drum and into position at winch assembly. Install two brake case to gear case cap screws, using lock washers. Force front base angle assembly down to position at brake case and install two base angle to brake case cap screws with lock washers. Coat base angle to gear case cap screws with aviation type cement and install cap screws with lock washers. Tighten cap screws firmly, and tighten base angle to end frame bolt. Assemble spring locating washer and nuts on adjusting end of brake band and tighten anchor nut.

(3) **INSTALL WINCH MOUNTING BOLTS AND FRONT BUMPER.** Install front base angle to side rail extension bolts, then install front bumper (par. 215 b (4)).

WINCH AND CONTROLS

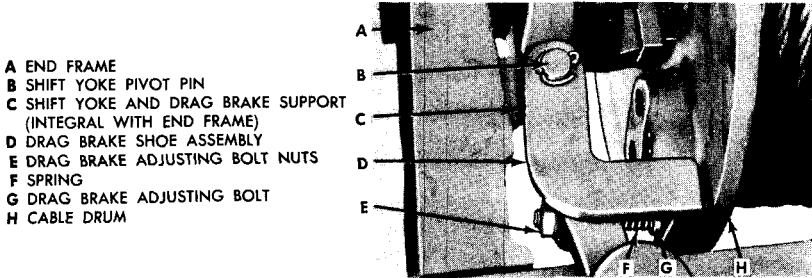

RA PD 332960

Figure 246—Winch Drag Brake Shoe Assembly

(4) ADJUST AUTOMATIC BRAKE. Adjust automatic brake (par. 236 d).

238. DRAG BRAKE SHOE ASSEMBLY.

a. **Drag Brake Shoe Assembly Removal** (fig. 246). Remove cotter pin from upper end of shift yoke pivot pin, then with hammer and punch, drive pin out of drag brake shoe, shift yoke, and pin supports. Lift poppet knob and move shift yoke toward end frame as far as possible, turning drum if necessary to obtain sufficient clearance, then turn drag brake shoe and remove it from winch assembly.

b. **Drag Brake Shoe Assembly Installation.** With clutch shift yoke held as close as possible to end frame, and drum turned to position which will provide clearance, guide drag brake shoe down between clutch shift yoke and end of drum. Move clutch shift yoke and drag brake as necessary to aline holes through same with holes through supports on end frame. Drive shift yoke pivot pin down through brake shoe, shift yoke, and supports, then secure by installing a cotter pin through each end of pin.

239. CABLE.

a. **General.** Winch cable is wire rope type with hemp core. One end of cable has a 4-foot length of chain attached by means of a safety clamp.

b. **Winch Cable Removal.**

(1) **UNWIND CABLE FROM DRUM.** Disengage sliding jaw clutch, unhook chain from tow hooks, then pull cable straight out from winch by hand.

(2) **DETACH CABLE FROM DRUM FLANGE.** Loosen two cable clamp nuts at outer side of right-hand drum flange, then pull cable out of clamp.

c. **Winch Cable Installation.**

(1) **ATTACH CABLE TO DRUM.** Insert end of cable through clamp at inner side of right-hand drum flange, then tighten clamp nuts at outer side of right-hand drum flange.

(2) **WIND CABLE ON DRUM.** Wind cable on drum (par. 24).

TRUCK, 2½-TON, 6 x 6

240. DRIVE SHAFT AND UNIVERSAL JOINTS.

a. **Description.** The winch drive shaft, which transfers power from power take-off to the winch assembly, is a solid type with a U-joint at each end. Forward U-joint is keyed to drive shaft and attached to winch worm shaft by a shear pin (fig. 243). Rear U-joint is keyed on power take-off shaft. Splines in rear U-joint forward yoke engage the splines at rear end of drive shaft to form a slip joint. A stop collar is installed on drive shaft ahead of slip joint to prevent drive shaft from sliding back into slip joint, thereby preventing front end of drive shaft from dropping off winch worm shaft in the event of shear pin failure.

b. **Drive Shaft and U-joint Removal.**

(1) **REMOVE DRIVE SHAFT FROM VEHICLE.** Pull cotter pin and remove shear pin. Loosen safety collar set screw and move collar forward. Slide drive shaft into slip joint until front universal joint yoke is free from winch worm shaft, then pull shaft out of slip joint and remove from vehicle.

(2) **REMOVE UNIVERSAL JOINT FROM POWER TAKE-OFF.** Loosen set screw in universal joint yoke at power take-off and pull universal joint from power take-off shaft. Remove key.

c. **Drive Shaft and U-joint Installation.**

(1) **INSTALL U-JOINT AT POWER TAKE-OFF.** Place key in slot in power take-off shaft. With set screw loosened, install joint yoke on power take-off, then tighten set screw firmly.

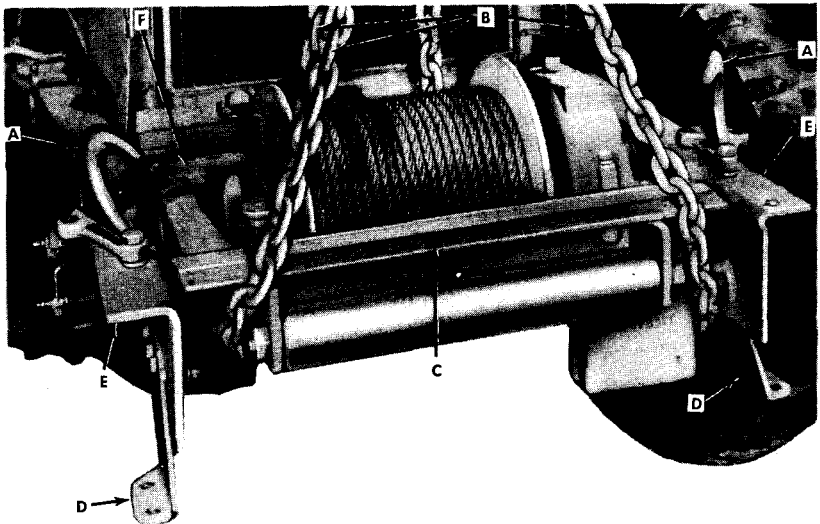

A TOW HOOK
 B SUPPORTING CHAIN
 C FRONT BASE ANGLE

D BUMPER BRACKET
 E SIDE RAIL EXTENSION
 F REAR BASE ANGLE

RA PD 332962

Figure 247—Method of Supporting Winch Assembly Prior to Removal

WINCH AND CONTROLS

(2) **INSTALL DRIVE SHAFT.** Loosen stop collar set screw so collar will move freely on drive shaft. Slide collar on splined end of shaft with set screw point between two of the splines. Coat drive shaft splines and inside of front U-joint with chassis grease. Insert splined end of drive shaft into rear U-joint yoke; then push forward U-joint yoke onto winch worm shaft.

(3) **INSTALL SHEAR PIN AND POSITION STOP COLLAR.** Dip a regulation shear pin in engine oil and install through U-joint yoke and hole through winch worm shaft and secure with cotter pin. **CAUTION:** *Regulation shear pins are designed to shear whenever overload occurs; as a safety measure, never use a substitute.* Locate stop collar on drive shaft so that a space of one-half inch exists between collar and nearest point on U-joint yoke (fig. 35).

241. WINCH ASSEMBLY REMOVAL.

a. **Remove Front Bumper and Brush Guard.** Remove front bumper (par. 215 b (3)), and remove brush guard (par. 217 c and d).

b. **Attach Hoist (fig. 247).** Attach chain-fall or other hoisting equipment to winch to support the assembly while attaching parts are being removed. Chain sling may be used as in figure 247.

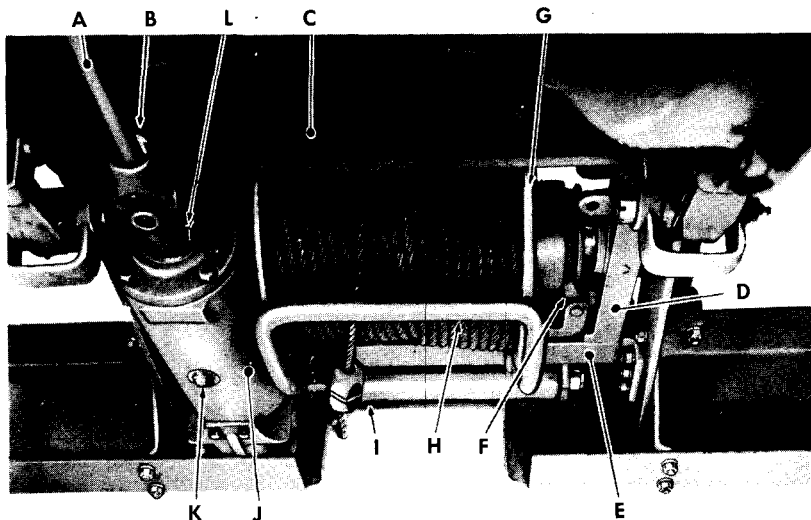

A WINCH DRIVE SHAFT
B DRIVE SHAFT KEY
C WINCH BASE ANGLE—REAR
D WINCH END FRAME
E WINCH BASE ANGLE—FRONT
F SLIDING JAW CLUTCH

G WINCH DRUM
H ROPE GUARD
I WINCH ROLLER
J WORM SHAFT HOUSING
K DRAIN PLUG
L SHEAR PIN

Figure 248—Winch Assembly Installed (Bottom View)

RA PD 64574

TRUCK, 2½-TON, 6 x 6

c. **Disconnect Winch Drive Shaft.** Remove cotter pin and remove shear pin from U-joint yoke. Loosen stop collar screw and pull drive shaft toward power take-off, thereby removing U-joint from winch worm shaft. Support drive shaft by suspending by wire attached to chassis.

d. **Remove Winch Assembly from Vehicle.** Remove front base angle to side rail extension bolts. Remove rear base angle to frame side rail bolts and washers. Move winch assembly forward and away from vehicle.

a. **Position Assembly at Vehicle.** Swing assembly to position, using chain-fall or other suitable hoist. Winch rear base angle must rest on forward end of frame side rails with bolt holes aligned.

b. **Install Mounting Bolts** (fig. 248). Install four rear base angle to frame side rail bolts, and six front base angle to side rail extension bolts. Use lock washers under all bolt nuts and tighten firmly.

c. **Install Radiator Brush Guard and Front Bumper.** Install brush guard (par. 217 d and e) and install front bumper (par. 215 b (4)).

d. **Connect Drive Shaft.** Coat inside of forward universal joint and shear pin with chassis grease. Remove wire used to suspend drive shaft and slide U-joint yoke onto winch worm shaft. Rotate drive shaft as necessary to aline shear pin holes in yoke and worm shaft; then insert shear pin and secure with cotter pin. Move drive shaft stop collar toward power take-off until one-half inch clearance exists between collar and forward edge of U-joint yoke; then tighten stop collar screw.

Section XLIV

POWER HOIST AND CONTROLS

243. GENERAL.

a. The power hoist mechanism consists primarily of a hydraulic cylinder and pump assembly (fig. 249), mounted beneath the dump body for the purpose of raising the front end of the body for dumping the load out rear of body. The hoist mechanism is connected by propeller shafts and U-joints to power take-off auxiliary drive shaft. Levers for controlling hoist mechanism are located in cab and are connected through linkage with power take-off and hoist pump

POWER HOIST AND CONTROLS

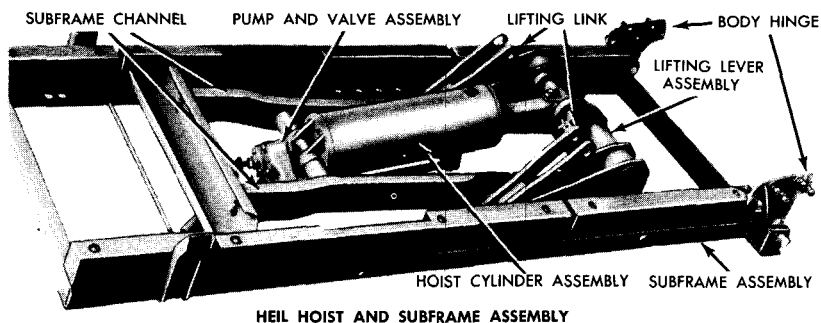

HEIL HOIST AND SUBFRAME ASSEMBLY

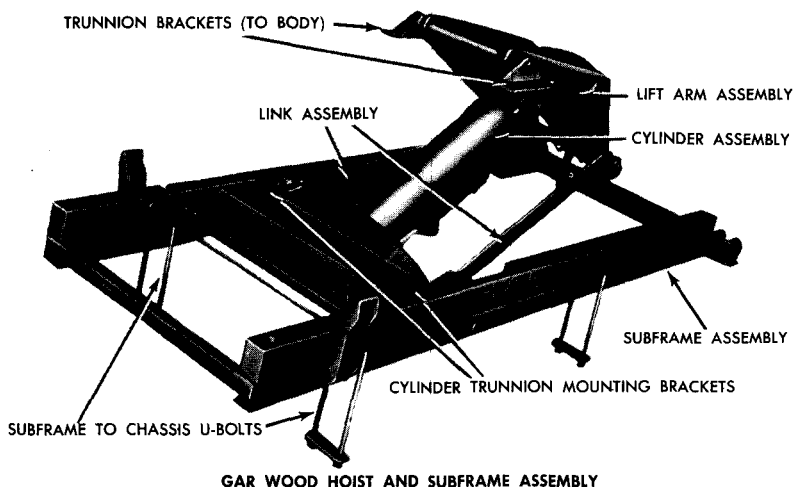

GAR WOOD HOIST AND SUBFRAME ASSEMBLY

RA PD 332969

Figure 249—Power Hoist Assembly Views

244. CONTROLS AND LINKAGE.

a. General. The power hoist—regardless of make—is controlled from the cab by two levers. One lever shifts the power take-off auxiliary drive in and out of engagement and the other lever, which is connected through rods and linkage with the control valve at hoist pump assembly, is used to control the raising and lowering of dump body. Levers and linkage used on early and late vehicles differ considerably, but both types serve the same purpose. Replacement of hoist power take-off lever and linkage, both early and late type, and hoist pump control lever used on early vehicles, is covered in Section XXVIII.

b. Hoist Pump Control Lever and Linkage Removal.

(1) **REMOVE HOIST PUMP CONTROL LEVER (EARLY VEHICLES).** Remove hoist pump control lever (par. 158 d (4) and (5)).

(2) **REMOVE HOIST PUMP CONTROL LEVER (LATE VEHICLES).** Remove clevis pin at lower end of lever which attaches rod to lever.

TRUCK, 2 1/2-TON, 6 x 6

Remove three bolts which attach lever bracket to brake master cylinder bracket; to remove, pull lever and bracket assembly down and remove from under vehicle. Remove bracket from lever.

(3) REMOVE LEVER TO HOIST PUMP RODS AND LINKAGE (fig. 250). Remove clevis pins from each end of control lever to pickup lever rod; then pull rod toward rear and remove from vehicle. Remove clevis pins which attach pickup lever to pump rod and remove rod. Forward end of rod is threaded and equipped with an adjustable rod end clevis and lock nut which may be removed if necessary. Remove pin (or bolt) which attaches pickup lever to frame bracket and remove lever.

c. Hoist Pump Control Lever and Linkage Installation.

(1) INSTALL HOIST PUMP CONTROL LEVER (EARLY VEHICLES). Install hoist pump control lever (par. 158 f (1), (2), and (4)).

(2) INSTALL HOIST PUMP CONTROL LEVER (LATE VEHICLES) (fig. 250). Assemble lever to bracket; then from below vehicle, place upper end of lever through floor pan opening and raise lever and

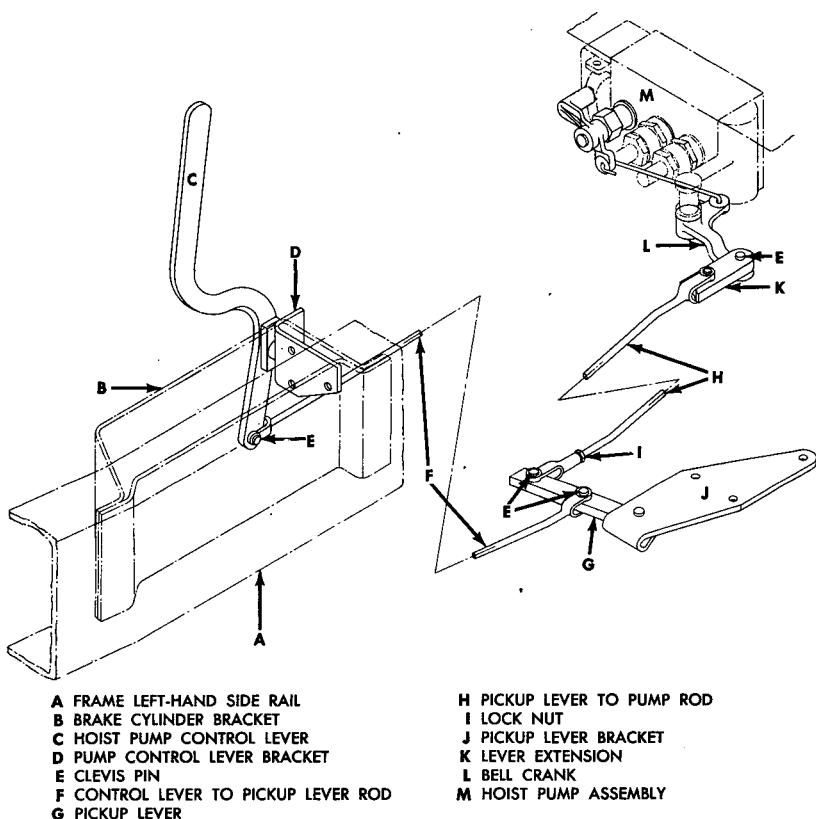

RA PD 333056

Figure 250—Hoist Pump Control Linkage (Late Vehicles)

POWER HOIST AND CONTROLS

bracket up to position at brake master cylinder bracket. Install three lever bracket to master cylinder bracket bolts and tighten firmly.

(3) **INSTALL PICKUP LEVER.** Position pickup lever at frame bracket and install pickup lever to frame bracket pin (or bolt). Secure pin with new cotter pin.

(4) **INSTALL CONTROL LEVER TO PICKUP LEVER ROD.** Insert forward end of control lever to pickup lever rod through hole in muffler support bracket and propeller shaft bearing support bracket. Connect forward end of rod to lower end of hoist pump control lever and rear end of rod to pickup lever, using clevis pins.

(5) **INSTALL ROD BETWEEN PICKUP LEVER AND HOIST PUMP ASSEMBLY.** With adjustable rod end clevis and lock nut installed on forward end of rod, attach rod to pickup lever and hoist pump bell crank. **NOTE:** *Gar Wood hoist linkage incorporates a lever extension (fig. 250) which attaches to rod with a clevis pin and is attached to hoist pump bell crank.* Attach rear end of rod to extension if vehicle is equipped with Gar Wood hoist or directly to bell crank if Heil hoist is used.

d. Hoist Pump Valve Control Linkage Adjustment. Spring loaded plunger is mounted in bell crank arm to locate valve in any one of three positions selected by operator, and link rod nearest hoist assembly has one adjustable rod and clevis. Make adjustment as follows:

(1) **ADJUST PUMP VALVE LINKAGE.** Remove clevis pin from adjustable clevis and move clevis away from idler lever. Consult "Shifting Arrangement Plate" and place hoist valve control lever in "RAISE" position. Move bell crank until plunger drops into depression at "RAISE" valve position, then adjust clevis on threaded end of rod so it can be reconnected to pickup lever without changing control lever or control valve positions. Position adjustable yoke at pickup lever and install clevis pin. Secure clevis pin with new cotter pin.

245. PROPELLER SHAFTS AND UNIVERSAL JOINTS.

a. General (fig. 251). Drive line from power take-off to hoist pump comprises three solid drive shafts connected by universal joints and supported by two steady bearings, which are attached to frame brackets. All U-joints are similar in construction except rear joint which, together with a special key in rear drive shaft, forms a slip joint. U-joint yokes are attached to drive shafts by set screws and Woodruff keys.

b. Removal. Removal of any individual shaft, U-joint, or steady bearing will be facilitated if complete drive line assembly is removed from vehicle.

(1) **REMOVE STEADY BEARINGS.** Remove nuts and lock washers from front and rear steady bearing studs.

(2) **REMOVE DRIVE LINE ASSEMBLY.** Loosen set screw attaching front U-joint to power take-off auxiliary drive shaft. Remove drive line assembly by pulling steady bearing studs from brackets;

TRUCK, 2 1/2-TON, 6 x 6

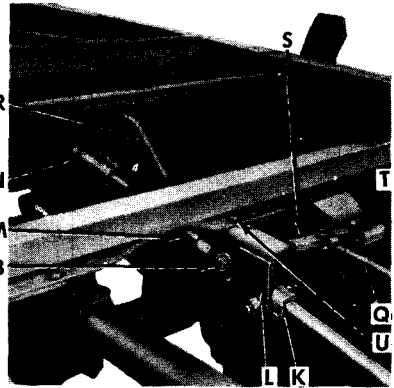
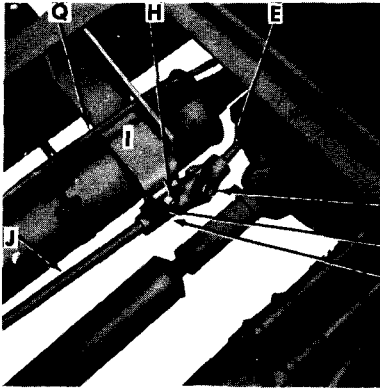
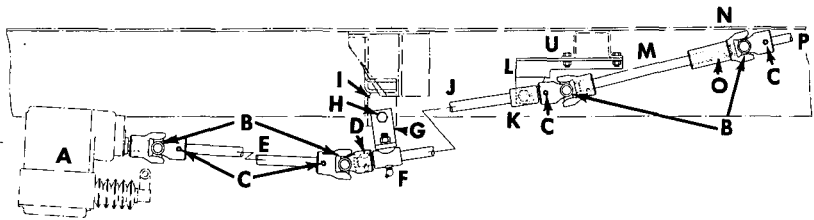

- A POWER TAKE-OFF
- B UNIVERSAL JOINT
- C SET SCREW
- D WOODRUFF KEY
- E FRONT SHAFT
- F STEADY BEARING—FRONT
- G STEADY BEARING BRACKET
- H BOLT AND NUT
- I FRAME BRACKET
- J CENTER SHAFT

- K STEADY BEARING—REAR
- L STEADY BEARING BRACKET
- M REAR SHAFT
- N UNIVERSAL AND SLIP JOINT
- O SPECIAL KEY
- P PUMP SHAFT
- Q FRONT CONTROL ROD
- R REAR CONTROL ROD
- S IDLER LEVER
- T IDLER LEVER SUPPORT
- U ADJUSTING BOLT

RA PD 332837

Figure 251—Hoist Propeller Shaft and Steady Bearing Installation

then moving assembly first rearward, then forward to remove front U-joint from power take-off and rear propeller shaft from slip joint. Do not lose special key out of rear shaft.

(3) REMOVE REAR U-JOINT. Loosen set screw which holds rear U-joint on hoist pump shaft, then remove joint from shaft.

(4) REMOVE U-JOINTS AND STEADY BEARINGS FROM PROPELLER SHAFTS. Remove five set screws which attach U-joints to shafts. Remove U-joints and Woodruff keys from shafts and slide the two steady bearings off center shaft.

(5) REMOVE STEADY BEARING SUPPORT BRACKETS FROM FRAME (fig. 251). Remove bolt attaching front steady bearing bracket to frame bracket, then remove bracket. Remove two bolts which attach rear steady bearing bracket to frame crossmember and remove bearing bracket from frame.

POWER HOIST AND CONTROLS

c. **Installation.** Drive line components should be assembled on bench and the assembly then installed on vehicle to facilitate the operation.

(1) **ATTACH STEADY BEARING BRACKETS TO FRAME.** Attach front steady bearing bracket to frame bracket, using bolt and lock washer as in figure 251. Attach rear steady bearing bracket to frame crossmember, using two bolts, with bracket in position as in figure 251.

(2) **INSTALL UNIVERSAL JOINTS TO FRONT SHAFT.** Install a Woodruff key at each end of shaft (28 $\frac{5}{8}$ in. long) and slide universal joint over shaft. Aline hole in yoke with hole in shaft. Install set screws and tighten. Prick punch each screw to prevent loosening.

(3) **INSTALL UNIVERSAL JOINT TO REAR SHAFT.** Install a Woodruff key at front end of shaft (14 $\frac{1}{4}$ in. long) and slide universal joint over shaft. Aline hole in yoke with hole in shaft. Install set screw and tighten. Prick punch screw to prevent loosening.

(4) **ASSEMBLE CENTER SHAFT.** Slide two steady bearings over center shaft (47 $\frac{1}{2}$ in. long). Install a Woodruff key at each end of shaft. Connect front and rear shafts to center shaft by sliding universal joints over ends. Aline hole in yoke with hole in shaft. Install set screw and tighten. Prick punch screw to prevent loosening.

(5) **INSTALL U-JOINT AT PUMP.** Install a Woodruff key in pump shaft and slide universal joint over shaft. Aline hole in yoke with hole in shaft. Install set screw and tighten. Prick punch screw to prevent loosening.

(6) **INSTALL UNIVERSAL JOINT AT POWER TAKE-OFF.** Install a Woodruff key in power take-off shaft. Loosen set screw in universal joint on end of front shaft. Aline slot in universal joint yoke with Woodruff key in power take-off shaft, then slide joint over shaft. Aline set screw with flat spot on shaft and tighten set screw. Prick punch head of screw to prevent loosening.

(7) **ATTACH REAR STEADY BEARING.** Install special Hi-Pro key at end of rear shaft. Raise propeller shaft sufficiently to insert end of shaft into universal joint slip yoke at pump. Insert rear steady bearing stud into support bracket on frame crossmember. Install lock washer and nut on stud.

(8) **ATTACH FRONT STEADY BEARING.** Raise propeller shafts as necessary to insert front steady bearing stud into support bracket, attached to frame bracket. Install lock washer and nut on stud.

(9) **ADJUST DRIVE LINE CLEARANCE.** Carefully inspect propeller shafts and universal joints to be sure they do not rub against muffler, brackets, or crossmembers. When necessary, use flat washers between steady bearing and bracket at rear, also between steady bearing bracket and frame bracket at front. Rear support bracket at crossmember can also be adjusted slightly to provide greater drive line clearance by loosening bolts attaching bracket to crossmember. Be sure bolts are again tightened when clearance has been obtained.

TRUCK, 2 1/2-TON, 6 x 6

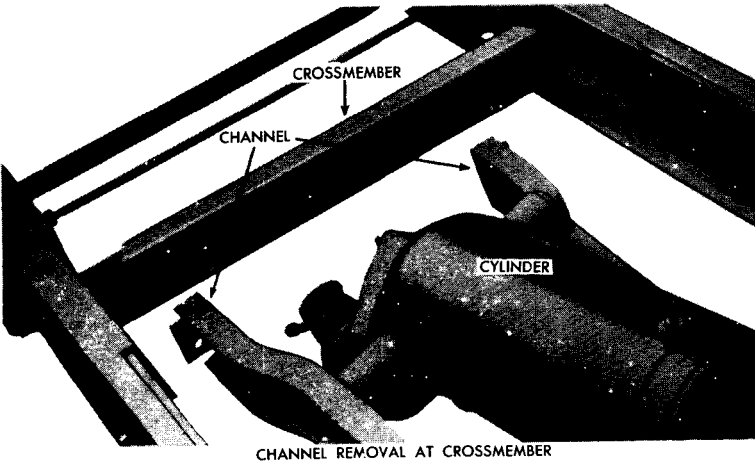
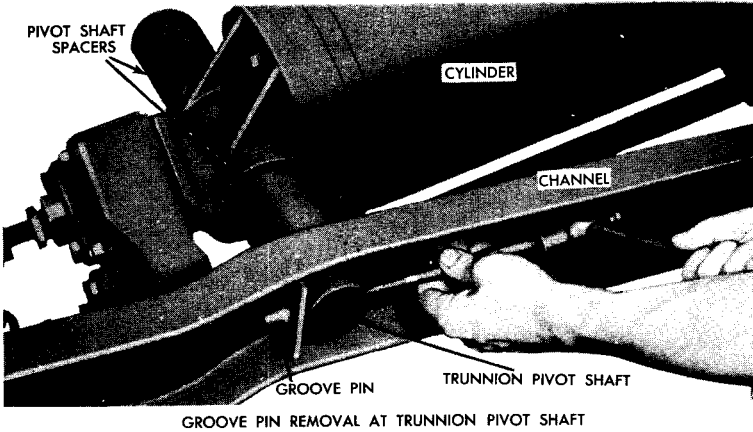
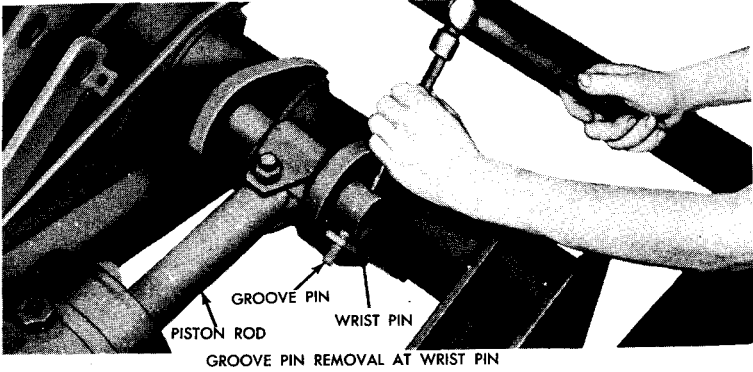

Figure 252—Heil Hoist Cylinder Removal

RA PD 332828

POWER HOIST AND CONTROLS

246. CYLINDER ASSEMBLY (HEIL HOIST).

a. **General.** The cylinder assembly used on Heil hoists is attached to the lifting mechanism by a tie bar which connects the piston rod to a wrist pin (fig. 252). Forward end of cylinder to which the pump assembly is attached is supported on a trunnion pivot shaft.

b. **Cylinder Removal (fig. 252).**

(1) **RAISE BODY AND DISCONNECT PROPELLER SHAFT.** Raise body and block securely to prevent dropping, then place pump control lever in "LOWER" position. Loosen set screw in U-joint yoke at pump shaft, remove nut and lock washer from rear steady bearing stud, then remove stud from bracket. Pull down on rear propeller shaft and at the same time remove joint yoke from pump shaft. Remove cotter pin and clevis pin which attach control rod to pump lever.

(2) **REMOVE HOIST WRIST PIN.** Use hammer and punch to drive groove pin from wrist pin and bracket (fig. 252). Use a heavy drift and sledge hammer and drive wrist pin from lever assembly and piston rod tie bar.

(3) **REMOVE CYLINDER AND PUMP ASSEMBLY.** Drive groove pin out of trunnion pivot shaft. Remove four nuts, lock washers, and bolts attaching two channels to subframe crossmember. Spread channels (fig. 252) and lift cylinder and pump assembly from vehicle. Remove pivot shaft and spacers from cylinder.

(4) **REMOVE PUMP ASSEMBLY FROM CYLINDER.** Support cylinder assembly so that fluid can be drained from pump. Remove drain plug from pump body and drain fluid into suitable receptacle—rotate pump shaft to force out all fluid. Remove four nuts and lock washers from studs attaching pump to cylinder manifold. Remove pump assembly and discard the gasket.

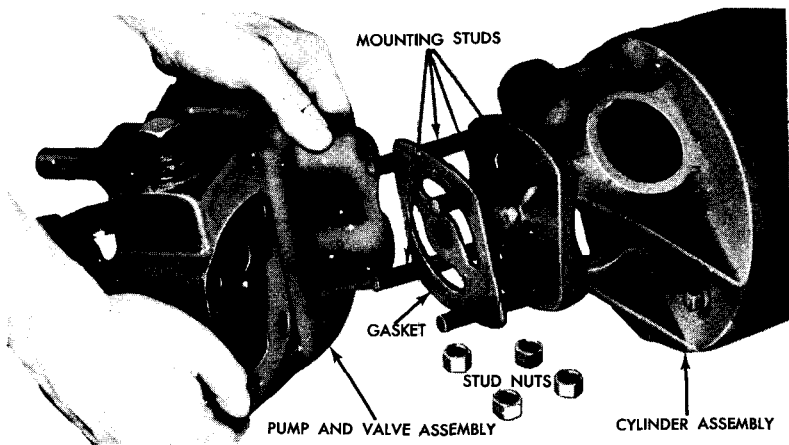

Figure 253—Heil Hoist Pump Installation At Cylinder

RA PD 332836

TRUCK, 2 1/2-TON, 6 x 6

c. Cylinder Installation.

(1) **ATTACH PUMP ASSEMBLY** (fig. 253). Place a new pump to cylinder gasket over studs and against cylinder manifold. Position pump assembly on studs with drain plug at bottom, and install four stud nuts and lock washers.

(2) **POSITION CYLINDER AT SUBFRAME.** Position cylinder assembly inside subframe members with oil filler hole on top and piston rod toward rear.

(3) **INSTALL TRUNNION PIVOT SHAFT.** Install pivot shaft through trunnion at rear of cylinder and position spacer on each end of shaft. Move two channels together so that ends of pivot shaft will enter holes in channels. Install groove pin through pivot shaft and into angle bracket. Drive groove pin tightly into shaft. Attach channels to subframe crossmember, using four bolts with nuts and lock washers.

(4) **INSTALL HOIST WRIST PIN.** Insert wrist pin through lifting lever and piston rod tie bar. Insert groove pin through angle bracket and into hole in wrist pin. Drive groove pin in tightly.

(5) **CONNECT PROPELLER SHAFT AND CONTROL ROD.** Raise rear propeller shaft upward, and at the same time guide the rear U-joint rear yoke onto pump shaft. Be sure key is in slot in pump shaft. Insert rear steady bearing stud through hole in support bracket and install stud nut and lock washer. Tighten set screw in rear U-joint yoke. Attach control rod to pump lever, using clevis pin and cotter pin. **NOTE:** *After installation is completed, inspect and adjust drive line as directed in paragraph 245 c (9).*

(6) **FILL HYDRAULIC CYLINDER.** Whenever pump assembly has been removed or cylinder disassembled, it is necessary that system be refilled with recommended hydraulic fluid (Section VIII).

(a) Remove the special vent plug in top of cylinder. Start engine and engage power take-off. Place hoist pump control lever, located in cab, in "RAISE" position. Pour fluid through opening with the pump running slowly until the body raises to its full height. When body has reached its full height, add about one-half pint more fluid.

(b) With power take-off still engaged and pump running, move control lever into "LOWER" position. Lower the body slowly until all the way down. Do not replace special vent plug at this time.

(c) Move control lever to "RAISE" position and again raise body slowly. Repeat raising and lowering operations several times to allow any surplus fluid to drain out. Install vent plug when body is in fully raised position.

247. CYLINDER ASSEMBLY (GAR WOOD HOIST).

a. General (fig. 249). The cylinder assembly, mounted between subframe members, consists of a cylinder with trunnion, cylinder head, and piston and rod assembly. The cylinder trunnion is supported at each subframe member by a trunnion mounting bracket. Piston rod is connected to lift arm cross head by a bolt.

POWER HOIST AND CONTROLS



GAR WOOD HOIST SAFETY CHAIN

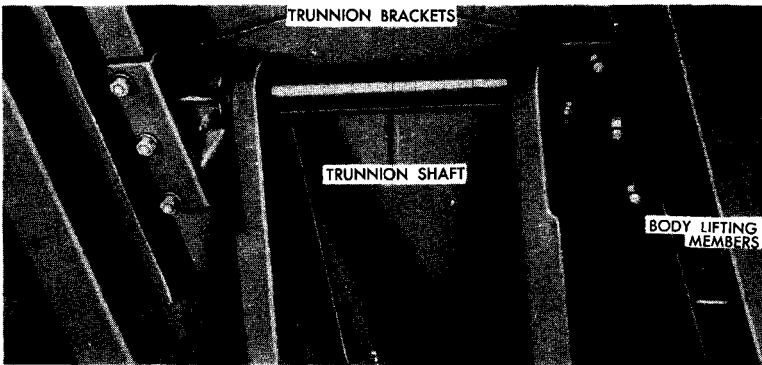

ATTACHMENT OF GAR WOOD HOIST TO BODY

RA PD 332961

Figure 254—Trunnion Bracket and Safety Chain Installations at Dump Body (Gar Wood Hoist)

b. **Cylinder Removal** (fig. 249). Removal of cylinder can be accomplished with body mounted on vehicle. Cylinder, pump, and lifting linkage should be removed as an assembly, then disassembled on bench.

(1) **RAISE BODY AND DISCONNECT PROPELLER SHAFT.** Accomplish procedure given in paragraph 246 b (1).

(2) **DISCONNECT LIFTING LINKAGE FROM BODY** (fig. 254). Lay suitable blocking across hoist subframe to support rear end of assembly while removing trunnion brackets and safety chain U-bolt. Remove six trunnion brackets to body bolts and remove nuts from U-bolt which attaches safety chain to body understructure.

(3) **REMOVE WOOD SILLS FROM SUBFRAME** (fig. 249). Remove wood sill center section, bolted to each side of subframe, to permit access to trunnion bracket bolt heads.

TRUCK, 2½-TON, 6 x 6

(4) **REMOVE TRUNNION BRACKET TO SUBFRAME BOLTS.** Remove four trunnion bracket to subframe bolts at each side of subframe.

(5) **LIFT ASSEMBLY FROM VEHICLE.** If personnel are available, three or four men can easily lift the cylinder and lifting linkage from vehicle; otherwise, attach suitable tackle and lift the assembly from vehicle.

(6) **REMOVE LIFTING LINKAGE FROM CYLINDER** (fig. 255). Remove hoist cylinder trunnion brackets. Remove piston rod to cross head bolt, then force cross head off piston rod. Remove bolts attaching link retaining collars to lifting arm trunnion shaft, then remove collars and links from the assembly. Set lifting linkage aside until ready to install cylinder.

(7) **REMOVE PUMP FROM CYLINDER** (fig. 257). Place hoist valve lever in "LOWER" position. Remove plate from bottom of pump and drain all fluid from assembly. Unscrew packing nut, attaching pump manifold to cylinder manifold, then move packing and nut away from cylinder. Remove five cap screws and washers attaching pump to cylinder manifold. Remove pump assembly and discard gaskets used between pump and cylinder. Replace plate which was removed for draining.

c. Cylinder Installation.

(1) **INSTALL PUMP ASSEMBLY ON CYLINDER.** Coat both sides of pump to cylinder body gaskets with aviation type cement. With new packing and packing nut in position on pump manifold (fig. 257), and pump to cylinder gaskets positioned on pump, attach pump to cylinder, using five cap screws and flat washers, with avia-

- A PISTON ROD TO CROSS HEAD BOLT
- B LIFT ARM
- C COLLAR
- D COLLAR RETAINING BOLT
- E HOIST CYLINDER
- F LINK

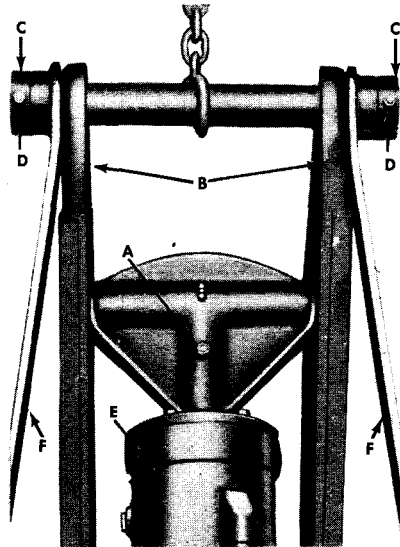

RA PD 333019

Figure 255—Lifting Linkage to Cylinder Assembly Connections

POWER HOIST AND CONTROLS

tion type cement under cap screw heads and on washers. Tighten cap screws evenly and alternately, then tighten packing nut on cylinder manifold threads.

(2) **INSTALL LIFTING LINKAGE ON CYLINDER AND PUMP ASSEMBLY.** Place cylinder and pump assembly on bench in operating position (with pump assembly below cylinder trunnion). Lay lifting arm linkage assembly on bench with trunnion bracket shaft resting on top of cylinder, then assemble cross head to piston rod and install bolt and nut. Slide links into position on cylinder trunnion and lift arm trunnion shaft, then install trunnion shaft collars and secure with bolts, nuts, and lock washers (fig. 255).

(3) **INSTALL CYLINDER, PUMP, AND LIFTING LINKAGE ASSEMBLY IN VEHICLE.** Place blocking as in subparagraph b (2) above, to support rear end of cylinder assembly. If personnel are available, three or four men can lift the assembly into position in hoist subframe; otherwise attach suitable tackle and swing the assembly into place in vehicle. As the cylinder is lowered into the subframe, place one cylinder trunnion mounting bracket on each cylinder trunnion. Attach trunnion mounting brackets to subframe, using four bolts with nuts and lock washers, placing bolt heads at outer side of subframe. Install wood sill center section at each side of subframe.

(4) **CONNECT PROPELLER SHAFT AND CONTROL ROD.** Accomplish procedure as given in paragraph 246 c (5).

(5) **FILL HYDRAULIC CYLINDER AND ATTACH LIFTING LINKAGE TO BODY.** Whenever pump assembly has been removed from cylinder, or hydraulic fluid drained from hoist for any reason, it is necessary to refill the hoist hydraulic system with recommended fluid (Section VIII).

(a) Remove filler plug at side of hoist cylinder. Place control valve lever (in cab) in "LOWER" position.

(b) With piston rod forced into cylinder as far as possible, add hydraulic fluid slowly to filler plug level; then install filler plug.

(c) Start engine, shift hoist power take-off lever to "IN" position and slowly operate hoist pump with the hoist pump valve lever in "RAISE" position. When piston rod has moved lifting linkage sufficiently to allow the attaching of trunnion brackets to body lifting member, place valve control lever in "HOLD" position.

(d) Attach trunnion brackets (fig. 254) to body lifting members, using three bolts with lock washers and nuts at each bracket; then with hoist, raise body sufficiently to relieve weight from blocking used to support body.

(e) With hoist fully raised, again remove filler plug from cylinder, fill cylinder to plug level, and reinstall plug.

(f) Repeat lowering, raising, and filling procedure until oil remains at filler plug hole level when body is in fully raised position. Raise and lower body slowly to prevent foaming of oil which creates air pockets.

(6) **ADJUST PUMP VALVE LEVER STOP SCREW.** Stop screw is provided in pump manifold to control pump valve opening at the lowering position.

TRUCK, 2½-TON, 6 x 6

(a) With hoist power take-off lever in the "IN" position and valve control lever in "LOWER" position, quickly accelerate engine. Note if body has a tendency to rise, in which case the stop screw must be turned down further until body does not move.

248. PUMP ASSEMBLY (HEIL HOIST).

a. **General.** Hoist pump and valve assembly is attached directly to forward end of hoist cylinder. Valve operating linkage, comprising a bell crank, support bracket, valve operating lever, and link, are included in the pump assembly. Adjustable packing glands are provided at pump drive shaft and valve operating shaft.

b. **Pump Packing Glands.** Two packing glands are utilized to prevent fluid leakage at pump assembly. Both glands are adjustable for normal packing wear, and are accessible with the pump installed on vehicle. Whenever adjustment fails to stop leakage, the glands must be repacked.

(1) PACKING GLAND ADJUSTMENT (fig. 256).

(a) Tighten the packing nut as necessary to stop leak around valve shaft; however, if valve linkage does not operate freely after adjustment, the necessity for packing replacement is indicated.

(b) To stop leakage at pump drive gear shaft, tighten stud nuts at packing gland alternately one-half turn at a time, until the leak is stopped or gland contacts pump body. Repack gland if leak continues after tightening nuts at gland.

(2) GLAND PACKING REPLACEMENT.

(a) *Replace Packing at Pump Valve Shaft.* Loosen lock nut and set screw at valve control lever and remove lever and key from

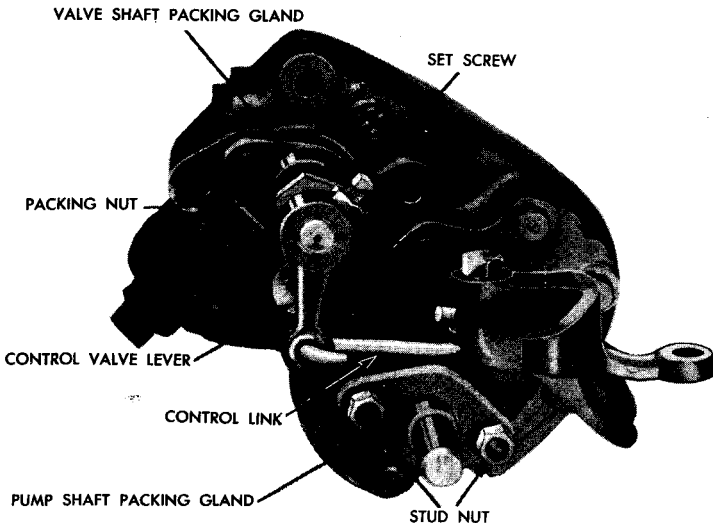

Figure 256—Heil Hoist Pump Assembly

RA PD 333057

POWER HOIST AND CONTROLS

shaft. Remove packing gland nut and remove all old packing from gland. Slide new packing onto shaft and into gland. Thread packing nut into gland to force packing into place, then with key in shaft, install valve control lever on shaft.

(b) *Replace Packing in Drive Gear Shaft Gland.* Place dump valve control lever in "HOLD" position, remove plug, and drain fluid from pump. Disconnect propeller shaft from pump (par. 246 b (1)). Remove stud nuts at packing gland, then remove gland from shaft and remove all old packing from gland. Do not lose packing retaining ring. Place new packing around shaft and against pump housing cover. Push packing retaining ring onto shaft, then install gland and stud nuts. Tighten nuts evenly as in step b (1) (b) above to firmly compress packing around shaft. Reconnect propeller shaft and install hydraulic fluid (par. 246 c (6)).

c. **Pump Removal.** Pump may be removed from vehicle without removing cylinder, body, or subframe.

(1) **DISCONNECT PROPELLER SHAFT.** Disconnect propeller shaft as directed in paragraph 246 b (1).

(2) **REMOVE PUMP ASSEMBLY.** Remove drain plug from pump body and allow all fluid to drain from pump—rotate pump shaft to expel all fluid. Remove four nuts from studs which attach pump to cylinder. Remove pump assembly and discard gasket.

d. **Pump Installation** (fig. 256).

(1) **ATTACH PUMP ASSEMBLY.** Coat a new pump to cylinder gasket with aviation type cement, then place gasket over studs and against cylinder. Position pump assembly on studs and install nuts and lock washers.

(2) **CONNECT PROPELLER SHAFT AND CONTROL ROD.** Connect propeller shaft and control rod as directed in paragraph 246 c (5).

(3) **INSTALL HYDRAULIC FLUID.** Fill hydraulic cylinder as di-

rected in paragraph 246 c (6).

249. PUMP ASSEMBLY (GAR WOOD HOIST).

a. **General.** Hoist pump assembly is attached by cap screws to the cylinder trunnion, and pump manifold is connected to cylinder through the use of packing, held in place by a packing nut (fig. 257). Propeller shaft from power take-off is connected to drive shaft (H, fig. 257), and hoist pump valve is operated by linkage which is connected to lever in vehicle cab. Pump is accessible for servicing and replacement with hoist assembly and body installed on the vehicle.

b. **Pump Packing Glands** (fig. 257). Packing glands are utilized to prevent fluid leakage at following four points: at pump assembly pump manifold (N), pump valve shaft (K), drive gear shaft (H), and idler gear shaft (J). Lock nuts (G) are used at gear shafts to prevent loosening of packing nuts.

(1) **PACKING NUT ADJUSTMENT.** In the event of leaks at any of the packing nuts, make adjustment as follows: If packing nut is locked by lock nut, back off lock nut first. Tighten packing nuts by turning clockwise until they are tight. Fluid should not leak. In the event

TRUCK, 2 1/2-TON, 6 x 6

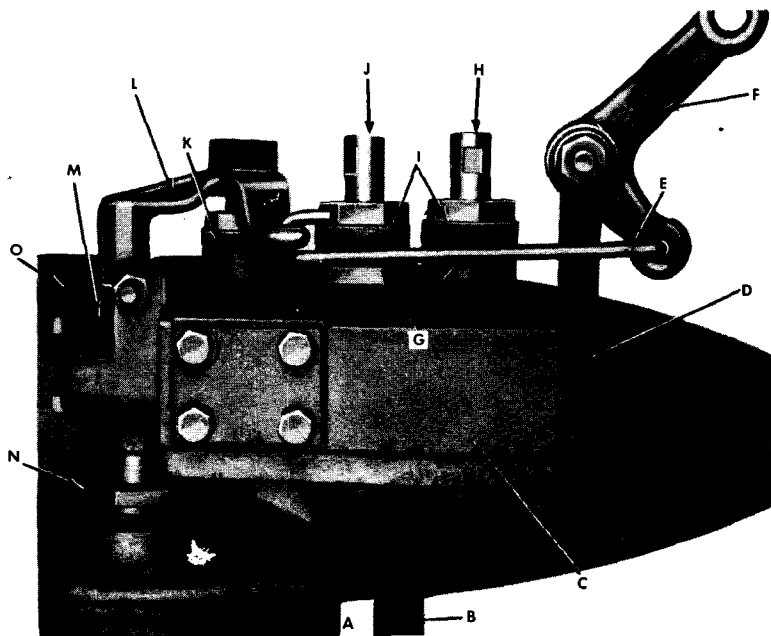

- | | |
|----------------------|------------------------------------|
| A CYLINDER | I PACKING NUTS |
| B LOW PRESSURE PIPE | J IDLER SHAFT |
| C PUMP ASSEMBLY | K VALVE PACKING NUT |
| D CONTROL BRACKET | L VALVE LEVER |
| E CONTROL LINK | M PUMP MANIFOLD |
| F CONTROL BELL CRANK | N MANIFOLD TO TRUNNION PACKING NUT |
| G LOCK NUTS | O CYLINDER TRUNNION |
| H DRIVE SHAFT | |

RA PD 332792

Figure 257—Gar Wood Hoist Pump Installed on Cylinder

ment by screwing lock nut up tightly against packing nut. If leak continues after adjustment, it will be necessary to replace packing.

(2) **GLAND PACKING REPLACEMENT** (fig. 257). Packing at pump manifold to cylinder connection does not require replacement except when pump or cylinder assembly is being replaced. If leak develops at that point, tighten packing nut.

(a) *Preliminary Instructions.* Before attempting any of the succeeding operations, raise dump body to full height and block securely. Place hoist valve control lever in "HOLD" position, remove plate at bottom of pump body, and drain fluid from pump into convenient receptacle.

(b) *Replace Packing at Pump Valve Shaft.* Loosen valve lever to pump shaft set screw, then remove lever and key from shaft. Do not lose spring and plunger from lever. Remove packing nut. Remove all old packing from nut. Place new packing around shaft, reinstall packing nut, and tighten sufficiently to prevent leak. Place key in shaft, then with spring and plunger in place in lever, and lever control link attached, install valve lever on shaft. Fill hy-

POWER HOIST AND CONTROLS

draulic cylinder as directed in paragraph 247 c (5).

(c) *Replace Packing at Pump Gear Shaft.* Procedure is same for replacing packing at the pump drive gear shaft and idler gear shaft.

1. Disconnect propeller shaft from pump (par. 246 b (1)). Loosen lock nut, then remove packing nut from shaft. Remove all old packing remaining in nut.

2. Place new packing around shaft, then install packing nut and adjust as directed in step (1) above. Connect propeller shaft as directed in paragraph 246 c (5).

3. Fill hydraulic cylinder as directed in paragraph 247 c (5).

c. **Pump Removal** (fig. 257). Hoist pump may be removed from vehicle without removing cylinder, body, or subframe.

(1) **RAISE AND BLOCK BODY.** Raise body as necessary to permit access to cap screws at upper side of cylinder trunnion, then securely block body in raised position.

(2) **DRAIN HYDRAULIC FLUID.** Place pump valve control lever in "LOWER" position, remove plate from lower side of pump assembly, and allow fluid to drain. *NOTE: To make certain that all hydraulic fluid has drained out, start engine and run hoist pump slowly with the hoist valve control lever in the "RAISE" position. Replace plate on pump after draining.*

(3) **DISCONNECT PROPELLER SHAFT AND CONTROL ROD.** Disconnect propeller shaft and control rod as directed in paragraph 246 b (1).

(4) **REMOVE PUMP ASSEMBLY.** Remove pump assembly as directed in paragraph 247 b (7).

d. **Pump Installation.**

(1) **INSTALL PUMP ASSEMBLY ON CYLINDER.** Install pump assembly on cylinder as directed in paragraph 247 c (1).

(2) **CONNECT PROPELLER SHAFT AND CONTROL ROD.** Connect propeller shaft and control rod at pump as directed in paragraph 246 c (5).

(3) **FILL HYDRAULIC CYLINDER.** Fill hydraulic cylinder as directed in paragraph 247 c (5).

APPENDIX

Section XLV

SHIPMENT AND TEMPORARY STORAGE

250. GENERAL INSTRUCTIONS.

a. Preparation for domestic shipment of the vehicle is the same as preparation for temporary storage or bivouac. Preparation for shipment by rail includes instructions for loading and unloading the

TRUCK, 2½-TON, 6 x 6

vehicle, blocking necessary to secure the vehicle on freight cars, number of vehicles per freight car, clearance, weight, and other information necessary to properly prepare the vehicle for rail shipment. For more detailed information and for preparation for indefinite storage, refer to AR 850-18.

251. PREPARATION FOR TEMPORARY STORAGE OR DOMESTIC SHIPMENT.

a. Vehicles to be prepared for temporary storage or domestic shipment are those ready for immediate service but not used for less than thirty days. If vehicles are to be indefinitely stored after shipment by rail, they will be prepared for such storage at their destination.

b. If the vehicles are to be temporarily stored or bivouacked, take the following precautions.

(1) **LUBRICATION.** Lubricate the vehicle completely (par. 37).

(2) **COOLING SYSTEM.** If freezing temperature may normally be expected during the limited storage or shipment period, test the coolant with a hydrometer and add the proper quantity of antifreeze to afford protection from freezing at the lowest temperature anticipated during the storage or shipping period. Completely inspect the cooling system for leaks.

(3) **BATTERY.** Check battery and terminals for corrosion and if necessary, clean and thoroughly service battery (par. 119).

(4) **TIRES.** Clean, inspect, and properly inflate all tires. Replace with serviceable tires, tires requiring retreading or repairing. Do not store vehicles on floors, cinders, or other surfaces which are soaked with oil or grease. Wash off immediately any oil, grease, gasoline, or kerosene which comes in contact with the tires under any circumstances.

(5) **ROAD TEST.** The preparation for limited storage will include a road test of at least 5 miles, after the battery, cooling system, lubrication, and tire service, to check on general condition of the vehicle. Correct any defects noted in the vehicle operation before the vehicle is stored, or note on a tag attached to the steering wheel, stating the repairs needed or describing the condition present. A written report of these items will then be made to the officer in charge.

(6) **FUEL IN TANKS.** It is not necessary to remove the fuel from the tanks for shipment within the United States, nor to label the tanks under Interstate Commerce Commission Regulations. Leave fuel in the tanks except when storing in locations where Fire Ordinances or other local regulations require removal of all gasoline before storage.

(7) **EXTERIOR OF VEHICLE.** Remove rust appearing on any part of the vehicle with sandpaper. Repaint painted surfaces whenever necessary to protect wood or metal. Coat exposed polished metal surfaces susceptible to rust, such as winch cables, chains, and in the case of track-laying vehicles, metal tracks, with medium grade

SHIPMENT AND TEMPORARY STORAGE

preventive lubricating oil. Close firmly all cab doors, windows, and windshields. Vehicles equipped with open type cabs with collapsible tops will have the tops raised, all curtains in place, and the windshield closed. Make sure tarpaulins and window curtains are in place and firmly secured. Leave rubber mats, such as floor mats, where provided, in an unrolled position on the floor, and not rolled or curled up. Equipment such as pioneer and truck tools, tire chains, and fire extinguishers will remain in place in the vehicle.

(8) **INSPECTION.** Make a systematic inspection just before shipment or temporary storage to insure all above steps have been covered and that the vehicle is ready for operation on call. Make a list of all missing or damaged items and attach it to the steering wheel. Refer to "Before Operation Service" (par. 42).

(9) **ENGINE.** To prepare the engine for storage, remove the air cleaner from the carbureter. Start the engine and set the throttle to run the engine at a fast idle, pour 1 pint of medium grade preservative lubricating oil, Ordnance Department Specification AXS-674, of the latest issue in effect, into the carbureter throat, being careful not to choke the engine. Turn off the ignition switch as quickly as possible after the oil has been poured into the carbureter. With the engine switch off, open the throttle wide and turn the engine five complete revolutions by means of the cranking motor. If the engine cannot be turned by the cranking motor with the switch off, turn it by hand or disconnect the high-tension lead and ground it before turning the engine by means of the cranking motor. Then reinstall the air cleaner.

(10) **BRAKES.** Release brakes and chock the wheels or tracks.
c. **Inspections in Limited Storage.**

(1) Vehicles in limited storage will be inspected weekly for conditions of tires and battery. If water is added when freezing weather is anticipated, recharge the battery with a portable charger or remove the battery for charging. Do not attempt to charge the battery by running the engine.

252. LOADING AND BLOCKING FOR RAIL SHIPMENT.

a. **Preparation.** In addition to the preparation described in paragraph 251, when Ordnance vehicles are prepared for domestic shipment, the following preparation and precautions will be taken.

(1) **EXTERIOR.** Cover the body of the vehicle with a canvas cover supplied as an accessory.

(2) **TIRES.** Inflate pneumatic tires from 5 to 10 pounds above normal pressure.

(3) **BATTERY.** Disconnect the battery to prevent its discharge by vandalism or accident. This may be accomplished by disconnecting the positive lead, taping the end of the lead, and tying it back away from the battery.

(4) **BRAKES.** The brakes must be applied and the transmission placed in low gear after the vehicle has been placed in position with a brake wheel clearance of at least 6 inches (fig. 258). The vehicles

TRUCK, 2 1/2-TON, 6 x 6

will be located on the car in such a manner as to prevent the car from carrying an unbalanced load.

(5) All cars containing Ordnance vehicles must be placarded "DO NOT HUMP."

(6) Ordnance vehicles may be shipped on flat cars, end door box cars, side door box cars, or drop end gondola cars, whichever type car is the most convenient.

b. Facilities for Loading. Whenever possible, load and unload vehicles from open cars under their own power, using permanent end ramps and spanning platforms. Movement from one flat car to another along the length of the train is made possible by cross-over plates or spanning platforms. If no permanent end ramp is available, an improvised ramp can be made from railroad ties. Vehicles may be loaded in gondola cars without drop ends by using a crane. In case of shipment in side-door cars, use a dolly type jack to move the vehicles into position within the car.

c. Securing Vehicles. In securing or blocking a vehicle, three motions, lengthwise, sidewise, and bouncing, must be prevented. There are two approved methods of blocking the vehicles on freight cars, as described below. When blocking dual wheels, all blocking will be located against the outside wheel of the dual.

(1) **METHOD 1** (fig. 258). Place two blocks (F, fig. 258), one across the front and one across the rear of the front wheels. Place one block "F" to the front of the forward rear wheels and one block "F" to the rear of the rearward rear wheels. These blocks must be at least eight inches wider than the over-all width of the vehicle at the car floor. Place sixteen cleats "E" against blocks "F" as shown in figure 258. Place one cleat "B" against the outside of each front wheel on the top of blocks "F." Place two cleats "C" against the outside of the rear wheels on the top of block "F" as shown in figure 258. Nail the cleats to each block "F" with two 40-penny nails. Pass six strands, two wrappings, of No. 8 gage, black annealed wire (D, fig. 258) through the spokes of the wheels and the stake pockets. Tighten the wires enough to remove slack. If a box car is used, apply this strapping in similar fashion and attach it to the floor by the use of blocking or anchor plates. This strapping is not required when gondola cars are used.

(2) **METHOD 2** (fig. 259). Place eight blocks "A" to the front and to the rear of each front wheel and to the front of each forward rear wheel, and to the back of each rearward rear wheel (fig. 259). Nail heel of the block to the car floor with five 40-penny nails, and toenail that portion of the block under the tire to the car floor with two 40-penny nails. Place two cleats "B" against the outside face of each front wheel. Place two cleats "C" against the outside face of the rear wheels. Nail the lower cleats to the car floor with three 40-penny nails and the top cleat to the cleats below with three 40-penny nails. Pass six strands, two wrappings, of No. 8 gage, black annealed wire (D, fig. 259) through the spokes of the wheels and the stake pockets. Tighten the wires enough to remove slack. If

SHIPMENT AND TEMPORARY STORAGE

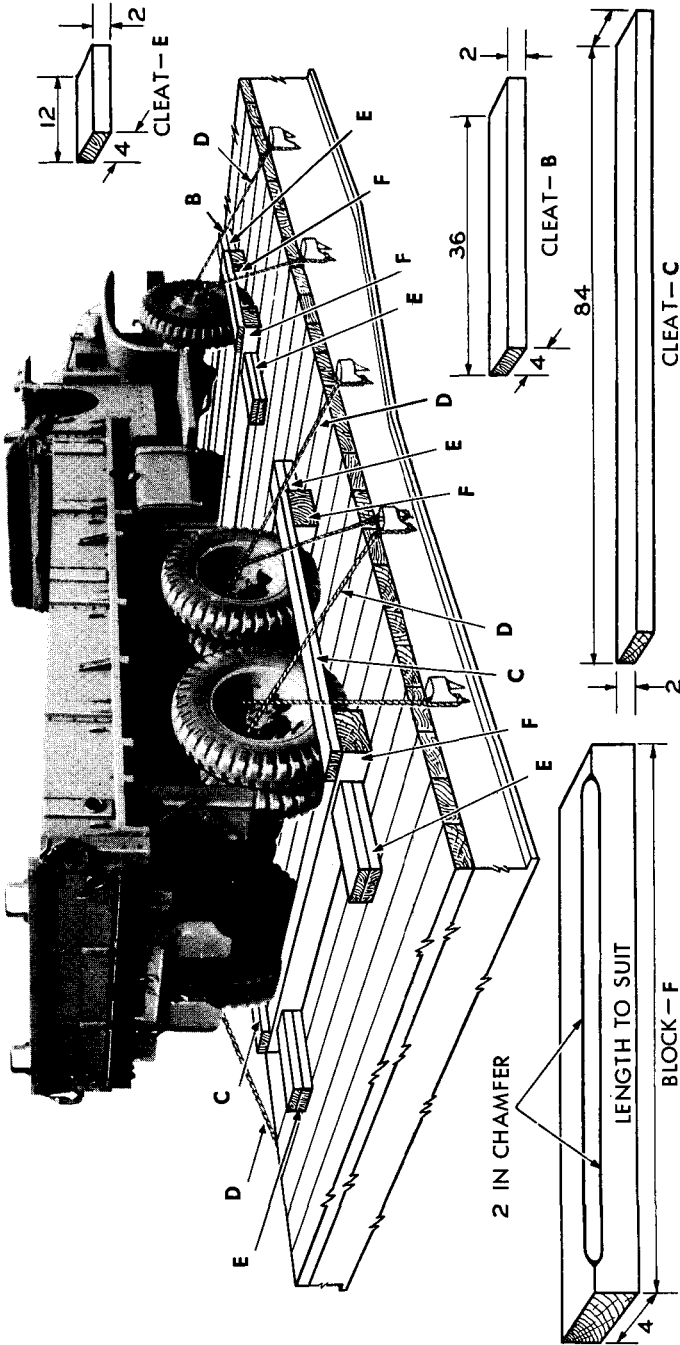

RA PD 64779

Figure 258—Method 1 for Blocking Truck on Freight Cars

TRUCK, 2½-TON, 6 x 6

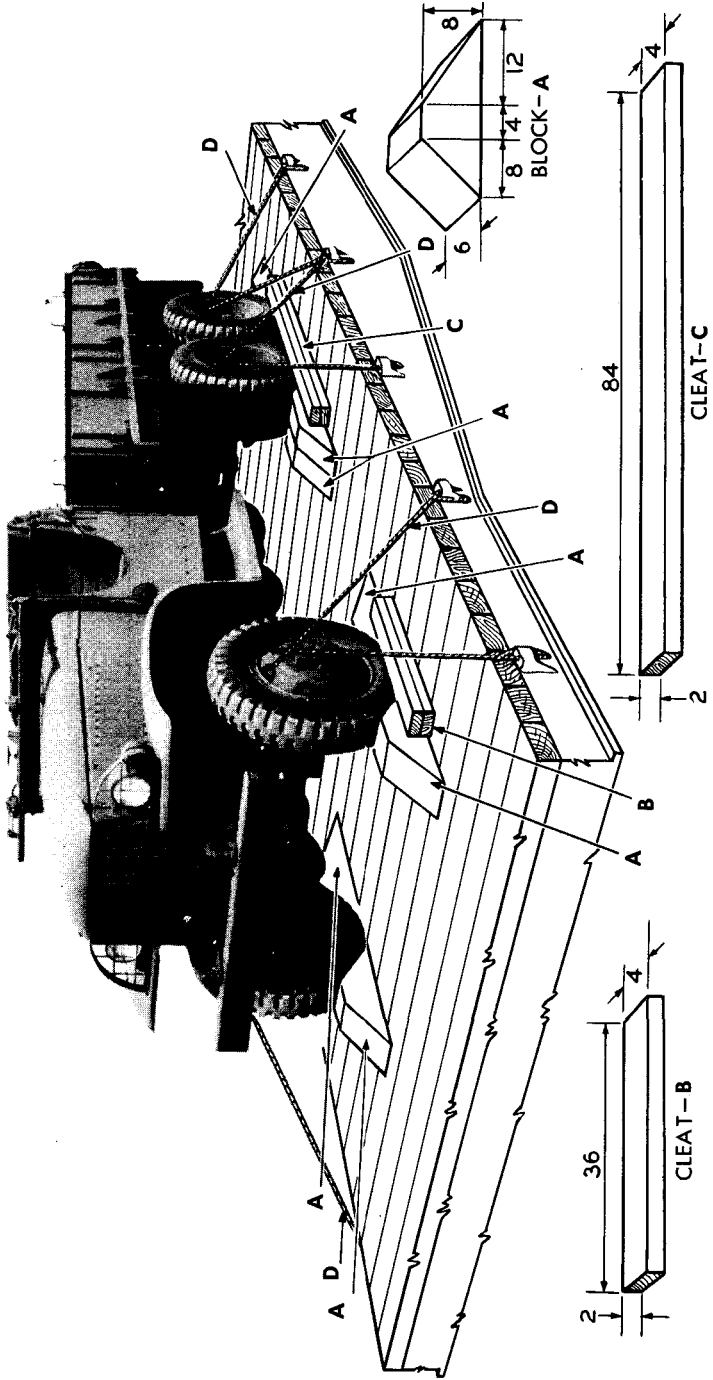

RA PD 64780

Figure 259—Method 2 for Blocking Truck on Freight Cars

SHIPMENT AND TEMPORARY STORAGE

a box car is used, apply this strapping in similar fashion and attach it to the floor by the use of blocking or anchor plates. This strapping is not required when gondola cars are used.

d. Shipping Data.

| | |
|--|-------------------------------------|
| Length, overall CCKW-352 Cargo Body | |
| without winch | 231 in. |
| with winch | 244 ⁷ / ₈ in. |
| Length, overall CCKW-353 Cargo Body | |
| without winch | 256 ¹ / ₄ in. |
| with winch | 270 ¹ / ₈ in. |
| Length, overall CCKW-353 Cargo Dump Body. | 272 ³ / ₄ in. |
| Length, overall CCKW-353 D1 Gasoline Tank Body | 253 ¹ / ₂ in. |
| Length, overall CCKW-353 G2 Water Tank Body | 253 ¹ / ₂ in. |
| Width, overall (all bodies) Maximum | 91 in. |
| Height, overall (all bodies) Maximum | 119 in. |
| Shipping Weight CCKW-352 and 353 Cargo Body | |
| without winch | 15,700 lb |
| with winch | 16,400 lb |
| Shipping Weight CCKW-353 Cargo Dump Body | 11,950 lb |
| Shipping Weight CCKW-353 Cargo Dump Body | 10,750 lb |
| Shipping Weight CCKW-353 G2 Water Tank Body | 12,025 lb |
| Approximate floor area occupied per vehicle: | |
| CCKW-352 { Cargo Body wo/winch | 146 sq ft |
| } Cargo Body w/winch | 155 sq ft |
| CCKW-353 { Cargo Body wo/winch | 162 sq ft |
| } Cargo Body w/winch | 171 sq ft |
| Cargo Dump Body | 173 sq ft |
| Gasoline Tank Body and Water Tank Body | 161 sq ft |
| Approximate volume occupied per vehicle: | |
| CCKW-352 { Cargo Body wo/winch | 1,448 cu ft |
| } Cargo Body w/winch | 1,536 cu ft |
| CCKW-353 { Cargo Body wo/winch | 1,606 cu ft |
| } Cargo Body w/winch | 1,693 cu ft |
| Cargo Dump Body | 1,710 cu ft |
| Gasoline Tank Body and Water Tank Body | 1,589 cu ft |

Section XLVI

REFERENCES

253. PUBLICATIONS INDEXES.

a. The following publications indexes should be consulted frequently for latest changes to or revisions of the publications given

TRUCK, 2 1/2-TON, 6 x 6

in this list of references and for new publications relating to materiel covered in this manual:

| | |
|--|------------------------|
| Introduction to Ordnance Catalog (explains SNL system) | ASF Cat. ORD-1 IOC |
| Ordnance publications for supply index (index to SNL's) | ASF Cat. ORD-2 OPSI |
| Index to ordnance publications (lists FM's, TM's, TC's and TB's of interest to Ordnance personnel, MWO's, OPSR's, BSD, S of SR's, OSSC's and OFSB's. Includes alphabetical listing of Ordnance major items with publications pertaining thereto) | OFSB 1-1 |
| List of publications for training (lists MR's, MTP's, T/BA's, T/A's, and FM's, TM's, and TR's concerning training) | FM 21-6 |
| List of training films, film strips, and film bulletins (lists TF's, FS's, and FB's by serial number and subject) | FM 21-7 |
| Military training aids (lists graphic training aids, models, devices, and displays) | FM 21-8 |

254. STANDARD NOMENCLATURE LISTS.

| | |
|--|-----------|
| Truck, 2 1/2-ton, 6x6 (GMC) CCKW-352 and 353 | SNL G-508 |
| Cleaning, preserving and lubrication materials, recoil fluids, special oils, and miscellaneous related items | SNL K-1 |
| Soldering, brazing and welding materials, gases and related items | SNL K-2 |
| Tool sets—Motor transport | SNL N-19 |

255. EXPLANATORY PUBLICATIONS.

a. Fundamental Principles.

| | |
|--|-----------|
| Automotive electricity | TM 10-580 |
| Lubrication of Ordnance materiel | TM 9-2835 |
| Basic maintenance manual | TM 38-250 |
| Driver's manual | TM 10-460 |
| Electrical fundamentals | TM 1-455 |
| Military motor vehicles | AR 850-15 |
| Motor vehicle inspections and preventive maintenance service | TM 9-2810 |
| Precautions in handling gasoline | AR 850-20 |
| Standard military motor vehicles | TM 9-2800 |
| The internal combustion engine | TM 10-570 |

b. Maintenance and Repair.

| | |
|--|----------|
| Cleaning, preserving, lubricating and welding materials, and similar items issued by the Ordnance Department | TM 9-850 |
|--|----------|

REFERENCES

| | |
|---|------------|
| Cold weather lubrication, and service of combat vehicles and automotive materiel. . . . | OFSB 6-11 |
| Maintenance and care of pneumatic tires and rubber treads | TM 31-200 |
| Ordnance maintenance: Body and power train for 2½-ton, 6x6, truck (GMC, CCKW-353 and 352) | TM 9-1801 |
| Ordnance maintenance: Power plant for 2½-ton, 6x6, amphibian truck (DUKW-353) and 2½-ton, 6x6, truck (GMC, CCKW-353 and 352) | TM 9-1802A |
| Ordnance maintenance: Carbureters (Zenith) | TM 9-1826C |
| Ordnance maintenance: Electrical equipment (Delco Remy) | TM 9-1825A |
| Ordnance maintenance: Vacuum brake systems (Bendix BK) | TM 9-1827B |
| Ordnance maintenance: Hydraulic brakes (Wagner) | TM 9-1827C |
| Ordnance maintenance: Fuel pumps | TM 9-1828A |
| Ordnance maintenance: Speedometers, tachometers and recorders | TM 9-1829A |
| c. Protection of Materiel. | |
| Camouflage | FM 5-20 |
| Chemical decontamination, materials and equipment | TM 3-220 |
| Decontamination of armored force vehicles. | FM 17-59 |
| Defense against chemical attack. | FM 2140 |
| Explosives and demolitions | FM 5-25 |
| d. Storage and Shipment. | |
| Ordnance storage and shipment chart, group G—Major items | OSSC-G |
| Registration of motor vehicles | AR 850-10 |
| Rules governing the loading of mechanized and motorized army equipment also major caliber guns, for the United States Army and Navy, on open top equipment published by Operations and Maintenance Department of Association of American Railroads. | |
| Storage of motor vehicle equipment. | AR 850-18 |

TRUCK, 2 1/2-TON, 6 x 6

INDEX

| A | Page No. | | Page No. |
|---------------------------------------|-----------------|---------------------------------------|-----------------|
| Accelerator—see carbureter controls | | Battery and lighting system | |
| Air cleaner, carbureter | | battery and cables | 238 |
| cleaning | 211 | blackout driving light | 245 |
| description | 210 | blackout marker lights | 246 |
| installation | 211 | headlights | 240 |
| removal | 210 | line voltage tests | 240 |
| Air cleaner, hydrovac | 353 | radio noise suppression | 270 |
| Alinement, frame | 404 | stop and taillights | 247 |
| Alinement, front wheel | 309 | trailer connector | 249 |
| Ammeter operation | 30 and 278 | Bearings, wheel—see hubs and bearings | |
| Axle, front | | Blackout driving light | |
| alinement | 309 | description | 245 |
| axle shafts and universal joints . | 315 | installation | 246 |
| data | 309 | lamp-unit installation | 245 |
| description | 309 | lamp-unit removal | 245 |
| installation | 320 | removal | 246 |
| removal | 319 | switch | 32 and 281 |
| shifting | 38 | Blackout marker lights | |
| tie rod | 314 | description | 246 |
| toe-in adjustment | 311 | installation | 247 |
| trouble shooting | 154 | lamp installation | 246 |
| Axles, rear | | lamp removal | 246 |
| axle shaft—banjo type | 321 | removal | 247 |
| axle shaft—split type | 322 | Bleeding brakes | 334 |
| data | 321 | Body, cargo | |
| description | 321 | mountings | 425 |
| installation | 324 | tailgate | 427 |
| removal | 323 | tarpaulin | 49 |
| trouble shooting | 154 | troop seats and cargo racks | 430 |
| Axle shafts and universal joints, | | Body, cargo dump | |
| front axle | 315 | mountings | 428 |
| Axle shaft, rear—banjo type | 321 | operation | 58 |
| Axle shaft, rear—split type | 322 | tailgate | 430 |
| | | troop seats and cargo racks | 430 |
| B | | Body, gasoline tank | |
| Battery and cables | | cabinets | 434 |
| battery charging | 238 | camouflage | 69 |
| battery installation | 239 | controls | 69 |
| battery removal | 238 | controls and linkage | 433 |
| battery tests | 238 | mountings | 432 |
| cables | 239 | operation | 67 |
| description | 238 | valves | 434 |

INDEX

| Page No. | Page No. |
|---|--|
| Body, water tank | installation—banjo type339 |
| auxiliary engine and pumping | installation—split type341 |
| unit 65 | removal—banjo type337 |
| cabinet doors440 | removal—split type341 |
| camouflage 69 | Brake shoes, rear |
| heating equipment 66 | adjustment337 |
| mountings435 | description345 |
| operation 63 | installation345 |
| pumping unit438 | removal345 |
| strainers439 | Brush guard407 |
| valves436 | Bumpers406 |
| Bonding, body and chassis261 | |
| Bond straps266 | C |
| Brake drum, hand362 | Cab |
| Brake drums, service346 | back curtain 48 |
| Brake, hand | general412 |
| adjustment362 | mountings412 |
| band installation365 | seats46 and 417 |
| band removal365 | side curtains 46 |
| description361 | top deck 47 |
| drum installation364 | windshield415 |
| drum removal362 | Cable, winch445 |
| linkage installation366 | Cables, battery239 |
| linkage removal365 | Camouflage equipment 69 |
| Brake pedal and linkage348 | Carbureter |
| Brakes, service | controls201 |
| adjustments335 | data197 |
| bleeding system334 | description199 |
| brake drums346 | idling mixture adjustment200 |
| description329 | idling speed adjustment200 |
| front brake shoes—banjo type337 | installation200 |
| front brake shoes—split type341 | removal200 |
| hydraulic and vacuum lines358 | Carbureter controls |
| hydrovac353 | accelerator pedal and linkage |
| master cylinder351 | installation205 |
| operation329 | accelerator pedal and linkage |
| pedal and linkage348 | removal204 |
| rear brake shoes345 | choke controls201 |
| stop light switch32 | description201 |
| system tests331 | hand throttle203 |
| trouble shooting155 | Cargo body—see body, cargo |
| vacuum check valve357 | Cargo dump body—see body, cargo |
| wheel cylinders356 | dump |
| Brake shoes, front | Cargo racks430 |
| adjustment335 | |
| description—banjo type337 | |
| description—split type341 | |

TRUCK, 2 1/2-TON, 6 x 6

| | Page No. | D | Page No. |
|----------------------------------|----------|-----------------------------------|----------|
| Check valve, vacuum | 357 | Description, vehicle | 6 |
| Circuits, electrical | 249 | Distributor | |
| Clutch | | condenser replacement | 193 |
| description | 284 | installation | 193 |
| installation | 287 | point adjustment | 190 |
| pedal and linkage | 285 | point installation | 192 |
| pedal free-travel adjustment .. | 284 | point removal | 192 |
| removal | 285 | removal | 193 |
| trouble shooting | 149 | Drag link, steering | 389 |
| Clutch pedal free-travel | 284 | Drive shaft and universal joints, | |
| Cold weather lubrication | 71 | winch | 446 |
| Cold weather operation | 69 | Driving the vehicle | 44 |
| Cooling system | | | |
| description | 220 | E | |
| cold weather protection | 73 | Electrical circuits | 249 |
| draining | 42 | Engine | |
| fan and belt | 223 | cooling system | 41 |
| filling | 41 | crankcase oil | 41 |
| hose and fittings | 229 | crankcase ventilation system... | 176 |
| radiator | 224 | cylinder head gasket | |
| service | 220 | replacement | 168 |
| thermostat | 227 | description | 161 |
| trouble shooting | 147 | fuel supply | 40 |
| water pump | 228 | hood | 419 |
| Controls | | installation | 181 |
| lever | 33 | manifolds | 165 |
| miscellaneous | 34 | oil filter | 175 |
| pedal | 33 | oil pan | 172 |
| Crankcase ventilation system | | removal | 178 |
| Cleaning | 177 | starting | 43 |
| description | 176 | tabulated data | 163 |
| ventilator tube and valve | | trouble shooting | 137 |
| replacement | 177 | tune-up | 163 |
| Cranking, hand | 43 | valve clearance adjustment ... | 164 |
| Cranking motor | | warm-up | 44 |
| cable | 239 | Equipment, vehicle | 20 |
| cleaning commutator | 231 | Exhaust system | |
| controls | 232 | bypass and control | 219 |
| replacement | 232 | description | 215 |
| switch | 32 | exhaust pipe | 215 |
| switch replacement | 232 | muffler and tail pipe | 217 |
| Curtains, cab side | 46 | trouble shooting | 147 |
| Cylinder head gasket replacement | 168 | Explanatory publications | 470 |

TRUCK, 2½-TON, 6 x 6

| | Page No. | | Page No. |
|--------------------------------------|----------|-------------------------------------|------------|
| Headlights (Cont.) | | description | 186 |
| lamp-unit removal | 243 | distributor, points, and | |
| removal | 243 | condenser | 190 |
| switch | 278 | radio noise suppression | 267 |
| Hoist, power | | spark plugs | 195 |
| controls and linkage | 449 | timing | 188 |
| cylinder (Gar Wood) | 456 | trouble shooting | 144 |
| cylinder (Heil) | 455 | Initial timing adjustment | 188 |
| operation | 58 | Instrument panel | |
| propeller shafts and universal | | installation | 273 |
| joints | 451 | removal | 272 |
| pump (Gar Wood) | 461 | Instruments, gages, and switches | |
| pump (Heil) | 460 | ammeter | 30 and 278 |
| trouble shooting | 161 | blackout driving light | |
| Hood, engine | 419 | switch | 32 and 281 |
| Horn and button | 282 | dimmer switch | 32 and 283 |
| Hot weather operation | 76 | fuel gage | 28 and 277 |
| Hubs and bearings—banjo type | | general | 272 |
| description | 379 | horn and button | 282 |
| installation—front | 380 | ignition switch | 28 and 278 |
| installation—rear | 382 | instrument panel | 272 |
| removal—front | 379 | main light switch | 31 and 278 |
| removal—rear | 381 | oil pressure gage | 30 and 276 |
| Hubs and bearings—split type | | panel lights and | |
| description | 383 | switches | 32 and 281 |
| installation—front | 384 | speedometer | 28 and 273 |
| installation—rear | 385 | stop light switch | 32 and 283 |
| removal—front | 383 | thermo gage | 28 and 276 |
| removal—rear | 385 | Introduction | 5 |
| Hydraulic and vacuum lines | 358 | | |
| Hydrovac | | L | |
| air cleaner | 353 | Light, blackout driving — see | |
| description | 353 | blackout driving light | |
| installation | 355 | Lights, blackout marker—see | |
| removal | 355 | blackout marker lights | |
| I | | Lights, stop and tail—see stop | |
| Identification, vehicle | 14 | and taillights | |
| Ignition coil | | Line voltage tests | 240 |
| installation | 196 | Loading and blocking for rail | |
| removal | 196 | shipment | 465 |
| Ignition system | | Lubrication | |
| coil | 196 | cold weather | 71 |
| data | 188 | instructions | 80 |
| | | order | 80 |

INDEX

| M | <i>Page No.</i> | M | <i>Page No.</i> |
|--------------------------------------|-----------------|--------------------------------------|-----------------|
| Manifold heat control | | Operation on steep grades | 78 |
| adjustment | 198 | Operation under unusual | |
| description | 198 | conditions | 69 |
| Manifolds, engine | | Operation under usual conditions . | 35 |
| description | 165 | | |
| heat control | 198 | P | |
| installation | 165 | Panel lights and switch | 281 |
| removal | 165 | Pillow block | |
| Manual advance adjustment | 190 | adjustment check | 327 |
| Master cylinder | | description | 325 |
| description | 351 | installation | 328 |
| installation | 351 | removal | 327 |
| push rod stop screw | | Pitman arm, steering | 388 |
| adjustment | 352 | Polarizing generator | 235 |
| removal | 351 | Power hoist—see hoist, power | |
| | | Power take-off | |
| N | | data | 293 |
| New vehicle run-in test | 99 | description | 292 |
| | | dual drive | 296 |
| O | | single drive | 293 |
| Oil filter | | trouble shooting | 153 |
| description | 175 | Power take-off, dual drive | |
| element replacement | 175 | controls installation | 300 |
| replacement | 176 | controls removal | 299 |
| Oil pan, engine | | installation | 297 |
| description | 172 | removal | 297 |
| draining | 172 | Power take-off, single drive | |
| gasket replacement | 172 | control lever installation | 296 |
| installation | 173 | control lever removal | 295 |
| removal | 173 | installation | 294 |
| Oil pressure gage | 30 and 276 | removal | 294 |
| Operating instructions | 28 | Preparation for temporary storage | |
| Operation, vehicle | | or domestic shipment | 464 |
| auxiliary equipment | 54 | Prevention of damage by | |
| cold weather | 69 | submersion | 79 |
| hot weather | 76 | Preventive maintenance service | |
| on sand or soft terrain | 78 | after-operation and weekly | 109 |
| on steep grades | 78 | at-halt | 108 |
| prevention of damage by | | before-operation | 104 |
| submersion | 79 | during-operation | 107 |
| under unusual conditions | 69 | first echelon | 103 |
| under usual conditions | 35 | second echelon | 114 |
| Operation of auxiliary equipment. 54 | | | |

TRUCK, 2 1/2-TON, 6 x 6

| Page No. | Page No. |
|---|--|
| Propeller shafts | Sheet metal |
| description325 | engine hood419 |
| installation327 | fenders and skirts421 |
| removal326 | hood side panels419 |
| trouble shooting155 | running boards and step hangers423 |
| Propeller shafts, and universal joints, power hoist451 | Shifting—transmission, transfer case, and front axlé 35 |
| Pump, water tank438 | Shipment and temporary storage.463 |
| R | Shipping data469 |
| Radiator | Shock absorbers403 |
| adjustment227 | Spare parts, vehicle 25 |
| brush guard407 | Spare wheel carrier408 |
| description224 | Spark plugs |
| installation226 | cleaning and adjusting.....195 |
| removal225 | installation196 |
| Radio noise suppression system | removal195 |
| battery circuit270 | Speedometer |
| body and chassis bonding261 | cable installation276 |
| data261 | cable removal275 |
| description260 | head installation273 |
| generating circuit269 | head removal273 |
| ignition circuit267 | operation 28 |
| lighting circuit271 | Spring suspension |
| trouble shooting152 | description392 |
| Rear axles—see axles, rear | front392 |
| Rear spring seat398 | rear398 |
| Records 5 | rear spring seat398 |
| References469 | shock absorber403 |
| Regulator, generator | torque rods402 |
| cover237 | trouble shooting159 |
| description237 | Standard nomenclature lists....470 |
| installation237 | Starting system |
| removal237 | cranking motor231 |
| Running boards and step hangers.423 | cranking motor controls.....232 |
| S | description230 |
| Seats, cab | trouble shooting148 |
| description46 and 417 | Steering system |
| installation418 | adjustment386 |
| removal417 | description386 |
| Seats, troop430 | drag link389 |
| Service brake system—see brakes, service | pitman arm388 |
| | steering wheel389 |
| | trouble shooting158 |

INDEX

| <i>Page No.</i> | <i>Page No.</i> |
|--|---|
| Stop and taillights | Top deck, cab 47 |
| description 247 | Torque rods 402 |
| installation 248 | Tow hooks 407 |
| lamp-unit installation 248 | Towing the vehicle 52 |
| lamp-unit removal 247 | Trailer connector 249 |
| removal 248 | Transfer case |
| Stop light—see stop and taillights | control adjustments 302 |
| Stop light switch 32 and 283 | control cross shaft and bracket |
| Strut rod adjustment, | installation 306 |
| transmission 291 | control cross shaft and bracket |
| Switch | removal 303 |
| blackout driving light . . 32 and 281 | control levers installation 305 |
| cranking motor 32 and 232 | control levers removal 304 |
| dimmer 32 and 283 | control rods installation 306 |
| ignition 28 and 278 | control rods removal 302 |
| main light 31 and 278 | description 301 |
| panel light 32 and 281 | installation 307 |
| stop light 32 and 283 | removal 306 |
| | shifting 35 |
| T | trouble shooting 154 |
| Tabulated data, vehicle 16 | Transmission |
| Taillights—see stop and taillights | description 288 |
| Tank body, gasoline—see body, gaso- | installation 290 |
| line tank | power take-off and controls . . . 292 |
| Tank body, water—see body, water | removal 288 |
| tank | shifting 39 |
| Tarpaulin, cargo body 49 | trouble shooting 153 |
| Temperature gage 28 and 276 | Troop seats 430 |
| Thermostat | Trouble shooting |
| description 227 | battery and lighting system . . . 150 |
| installation 228 | brakes, service 155 |
| removal 227 | clutch 149 |
| Throttle, hand—see carbureter | cooling system 147 |
| controls | engine 137 |
| Tie rod, front axle 314 | exhaust system 147 |
| Tires | front and rear axles 154 |
| inflation 370 | fuel system 145 |
| replacement 370 | generating system 149 |
| Toe-in adjustment 311 | ignition system 144 |
| Tools | power hoist 161 |
| pioneer 20 | power take-off 153 |
| special 27 | propeller shafts 155 |
| vehicle 20 | radio noise suppression |
| | system 152 |
| | springs 159 |
| | starting system 148 |

TRUCK, 2 1/2-TON, 6 x 6

| | Page No. | | Page No. |
|--------------------------------------|----------|---------------------------------|----------|
| Trouble shooting (Cont.) | | Wheel cylinders | |
| steering system | 158 | description | 356 |
| transfer case | 154 | installation | 357 |
| transmission | 153 | removal | 356 |
| wheels, hubs, and tires | 157 | Wheel, steering | 389 |
| winch | 160 | Wheels | |
| Tune-up, engine | 163 | bearing adjustment | 373 |
| | | cleaning and lubricating | |
| | | bearings | 375 |
| U | | description | 366 |
| Universal joints, front axle shaft | 315 | hubs and bearings—banjo type | 379 |
| Universal joints, propeller shaft | 325 | hubs and bearings—split type | 383 |
| | | replacement | 369 |
| | | spare wheel carrier | 408 |
| V | | tightening | 367 |
| Vacuum check valve | 357 | trouble shooting | 157 |
| Valve clearance adjustment | 164 | Winch | |
| Vehicle | | adjustments | 441 |
| cold weather protection | 73 | automatic brake | 443 |
| description | 6 | cable | 445 |
| driving | 44 | controls | 54 |
| equipment | 22 | data | 441 |
| identification | 14 | description | 440 |
| operation | 35 | drag brake | 445 |
| run-in test | 99 | drive shaft and universal joint | 446 |
| spare parts | 25 | installation | 448 |
| special tools | 27 | operation | 54 |
| tabulated data | 16 | removal | 447 |
| tools | 20 | shear pin replacement | 58 |
| towing | 52 | trouble shooting | 160 |
| | | Windshield | |
| W | | installation | 416 |
| Water pump | | operation | 49 |
| description | 228 | removal | 415 |
| installation | 229 | wipers | 416 |
| removal | 229 | Windshield wipers | 416 |
| Water tank body—see body, water tank | | Wiring, harnesses, and circuits | |
| Wheel alinement | 309 | circuits | 249 |
| | | general | 249 |
| | | wiring and harnesses | 253 |